



Vitra

PRO Technic

PRO

Technic

PRO

VitrA further enriched its VitrA PRO Ceramic Tile Collection featuring numerous products, colours, patterns, materials, surface textures and solutions, which aims to inspire architects and interior designers and to help the professionals materialize their dream designs.

VitrA PRO Ceramic Tile Collection is composed of PRO Nature; material options inspired by nature, PRO Technic; colour diversity, different surfaces and durability options, and PRO Solutions which are solution specific portfolios for pools and facades compiled from these two lines.

VitrA, mimarlara ve iç mimarlara ilham verecek, profesyonellerin hayallerini tasarlamalarına yardımcı olacak, sayısız ürün, renk, desen, malzeme, yüzey özelliği ve çözüm barındıran VitrA PRO Karo Seramik Koleksiyonu'nu daha da zenginleştirdi.

VitrA PRO Karo Seramik Koleksiyonu'nda; doğadan ilham alan malzeme seçenekleri ile PRO Nature, renk çeşitliliği, farklı yüzeyler ve dayanıklılıkta alternatifler sunan PRO Technic ve bu ikisinden seçilmiş ürünlerle, kullanım yerine özel havuz ve dış cephe çözümlerini bir araya getiren PRO Solutions bulunuyor.

PRO Nature

Natural material textured tiles
Doğal malzeme dokulu karolar

Concrete / Beton
Stone / Taş
Wood / Ahşap
Marble / Mermer
Ceramic / Seramik

PRO Technic

Colours, surfaces, fullbody
porcelains and technic tiles

Renkler, yüzeyler, fullbody porselenler
ve teknik karolar

Color
Function
Matrix

PRO Solutions

Integrated tiles solutions compiled from PRO Nature and
PRO Technic products.

PRO Nature ve PRO Technic ürünlerinden oluşturulmuş
entegre karo çözümleri.

Pool / Havuz
Facade / Dış cephe

PRO

Technic

Color tactics	12
Renk oyunları	
Basic	20
Aqua	26
Neutral	32
Mood	38
Color options overview	46
Renk seçeneklerine genel bakış	
Color options in size order	48
Ebatlara göre renk dizilimi	
Size options in color order	68
Renklere göre ebat dizilimi	
Color Mix	76
Color Mix	
Color groups	82
Renk grupları	
Color and Function matching table	84
Color ve Function uyum tablosu	
Complementary pieces - trims	86
Tamamlayıcı parçalar	
Beyond function	106
Fonksiyonun ötesinde	
Uni	114
Dots	122

Index

İçindekiler

Color options overview Renk seçeneklerine genel bakış	130
Color options in size order Ebatlara göre renk dizilimi	132
Size options in color order Renklere göre ebat dizilimi	140
Special surfaces & thickness Özel yüzeyler & kalınlık	142
Complementary pieces - trims Tamamlayıcı parçalar	148
Discover Matrix Matrix'i keşfedin	172
Random 1	180
Random 2	182
Plain	184
Geometric 1	190
Geometric 2	192
Flake	194
Color options in size order Ebatlara göre renk dizilimi	198
Price list Fiyat listesi	204
Technical information Teknik bilgiler	234

PRO

Technic

Design your dreams with function and aesthetics

Imagine freely in your design. Combine the function and aesthetics, create long lasting, durable and joyful environments where people can live and materials can move safely.

In PRO Technic, VitrA combines the tiles offering technical and aesthetic solutions for different areas of use. PRO Technic does not only offer safe solutions with architectural requirements but also holds as an inspiration to create unique spaces with innovative applications.

Fonksiyon ve estetik ile hayallerini tasarla

Tasarımında özgürce hayal et. Fonksiyon ve estetiği bir araya getir, insanların üzerinde yaşayacağı, hareketin devam edeceği, uzun ömürlü, zevkli ve güvenli alanlar yarat.

VitrA, PRO Technic koleksiyonlarında; farklı kullanım alanları için teknik ve estetik çözümler sunan karoları bir araya getirdi. PRO Technic yalnızca mimari ihtiyaçlar için güvenilir çözümler sunmakla kalmıyor, yenilikçi uygulamalar ve benzersiz mekânlar yaratmak için de ilham veriyor.



Color tactics

Renk oyunları



Beyond function

Fonksiyonun ötesinde



Discover matrix

Matrix'i keşfedin



Durable, resistant to shatter and scratch

One of the most remarkable features of VitrA PRO Technic tiles is their paramount strength and durability. Porcelain tiles do not get scratched easily by hard surfaces unlike the natural materials and resistant against shocks and overloads. Therefore, they can be safely preferred in high-traffic areas such as shopping centres, cafes, restaurants and offices as well as in spaces where items that scratches surfaces such as chairs and tables are heavily used.

Kırılma ve çizilmeye dayanıklıdır

VitrA PRO Technic karolarının en önemli özelliklerinden biri üstün sağlamlık ve dayanıklılık performansdır. Porselen karolar doğal malzemelerin aksine sert yüzeylerle çizilmez, darbeye ve aşırı yüke dayanıklıdır; bu nedenle alışveriş merkezi, kafe, restoran ve ofis gibi insan trafiğinin, ayrıca sandalye ve masa gibi yüzey çizilen eşyaların yoğun olduğu mekânlarda güvenle tercih edilebilir.



Hygienic, easy to clean, resistant to chemicals

VitrA PRO Technic tiles are resistant to cleaning chemicals. Therefore, they can be used safely in homes, educational establishments, hospitals and high-traffic locations which require frequent cleaning.

Hijyeniktir, kolay temizlenir, kimyasallara dayanıklıdır

VitrA PRO Technic karolar temizlik kimyasallarına karşı dayanıklıdır. Bu nedenle konutlar, eğitim kurumları, hastaneler ve sık temizlik gerektiren yoğun trafikli mekânlarda için hijyen özelliği ile güvenle kullanılabilir.



Long lasting, colorfast, non-fading

VitrA PRO Technic tiles do not get effected by sun and water and they do not discolour. Their eye-catching brand new appearance can be preserved.

Uzun ömürlüdür, rengi ve deseni solmaz

VitrA PRO Technic karolar güneş ve su gibi dış etkenlerden etkilenmez, renk ve desenlerinde solma olmaz. Her türlü zorlu koşulda ilk günkü göz alıcı görünümünü korur.



Offering products in different anti-slip classes

One of the major features of VitrA PRO Technic tiles is that they come in diverse anti-slip grades. They can be used safely for many years in all spaces, homes or professional spaces where anti-slip feature is required and damp and wet floors pose a danger.

Farklı kaymazlık sınıfında ürünler sunar

VitrA PRO Technic karoların en önemli özelliklerinden biri farklı kaymazlık sınıflarında ürünler sunmasıdır. Kaymazlığın gerekli olduğu, nemin ve ıslak zeminlerin tehlike yarattığı tüm alanlarda, ev ya da profesyonel mekânlarda uzun yıllar güvenle kullanılabilir.

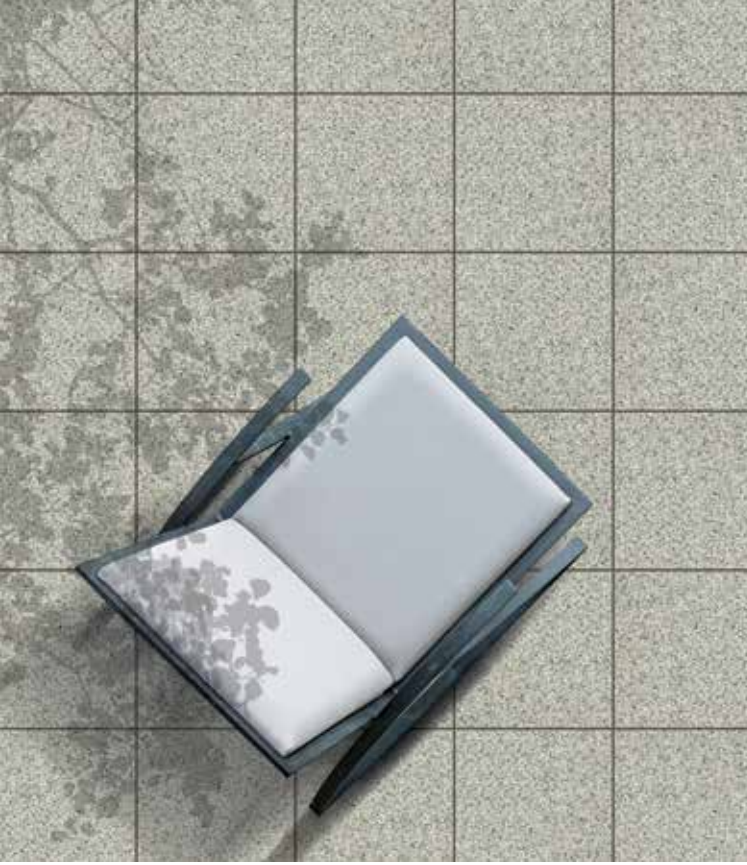

Safe to use in outdoors

VitrA PRO Nature porcelain tile is a product which can be used hassle-free in outdoors for many years, as it is strong and durable. It is not affected by hot and cold temperature changes and is resistant against rain, snow and frost. It is ideal for outdoor spaces such as courts and terraces.

Dış mekânlarda güvenle kullanılır

VitrA PRO Nature porselen karo sağlam ve dayanıklı olma özelliğiyle dış mekânlarda uzun yıllar problemsiz kullanılabilir bir üründür. Sıcak ve soğuk ısı değişimlerinden etkilenmez; yağmur, kar ve dona dayanıklıdır. Bahçe ve teras gibi dış mekânlara için idealdir.



Salt and chlorine-proof

Salt and chlorine have corrosive effect on surfaces over the course of time. VitrA PRO Technic tiles are an ideal choice for wet areas such as pool sides, ponds, beach perimeter, etc. and they are not affected by salt and chlorine.

Tuz ve klordan etkilenmez

Tuz ve klor uzun süre temas ettikleri yüzeyleri aşındırır. VitrA PRO Technic karolar tuz ve klordan etkilenmeyen yapısıyla havuz kenarı, süs havuzu, plaj çevresi gibi alanlarda uzun yıllar kullanmak için ideal bir seçimdir.



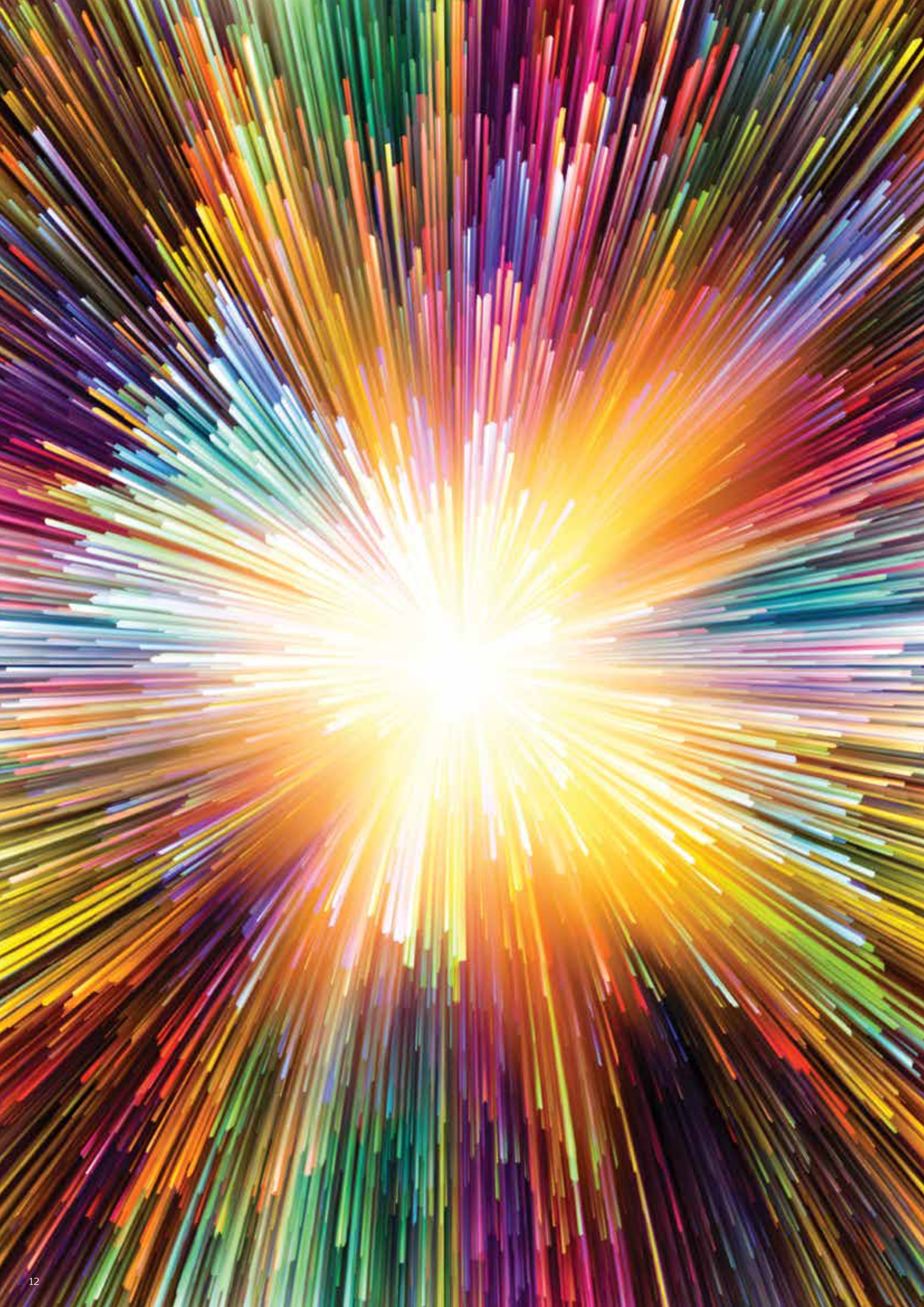

Color tactics

Renk oyunları

A wide palette which you can play with its colors, create unique structures with, and revitalize spaces with, is offered to provide you the freedom to design your dreams.

Renklerle oynayabileceğiniz, benzersiz alanlar yaratabileceğiniz ve mekânlara hayat katabileceğiniz çeşitlilikte bir renk paleti size hayallerinizi tasarlama özgürlüğü sunuyor.

Color

World of colors

RAL color design system, is based on the internationally accepted color standard with the Cielab color measurement method.

RAL system is offered in Vitra PRO Color products. Any desired atmosphere can be created in any space with Vitra PRO Color products which consist of countless color options.

Renklerin dünyası

Vitra PRO Color ürünlerinde, Cielab renk ölçüm metodunun temel alındığı, uluslararası kabul edilmiş renk standardı olan RAL renk tasarım sistemi kullanılıyor. Sayısız renk seçeneğini içinde barındıran Vitra PRO Color ürünleriyle istenen atmosfer her türlü mekânda yaratılabiliyor.

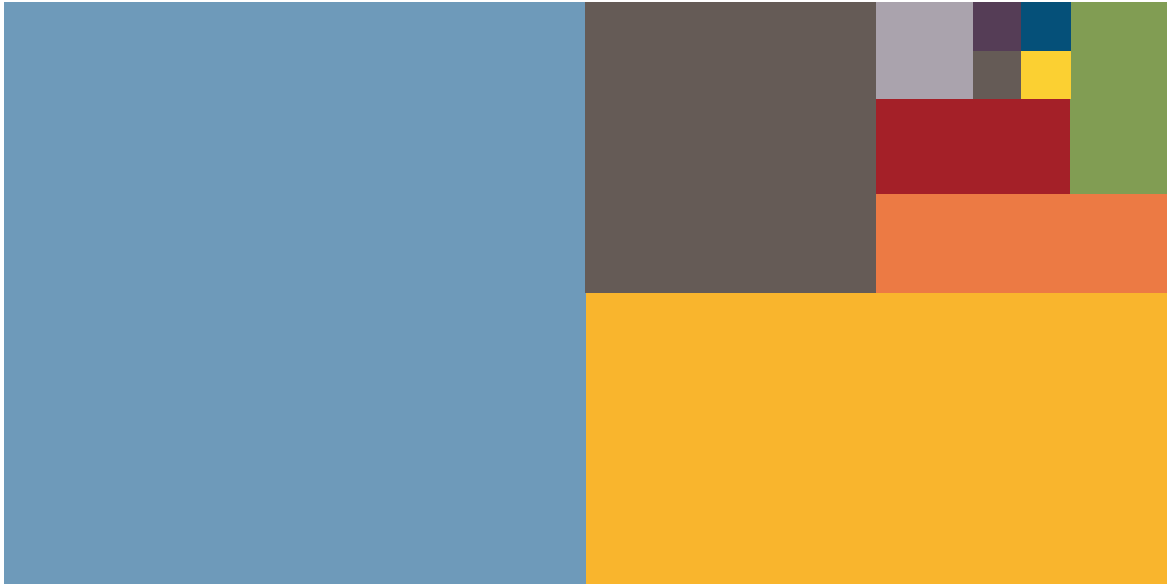

Modularity everywhere

The bathroom of a small house or a gigantic shopping mall, the modular structure of PRO Color lets designs of different magnitudes occur in coherence. 11 different sizes of porcelain and wall tiles from 2.5x2.5 cm up to 30x60 cm are produced in accordance with 3 mm joint spaces. Countless design needs can be realized by combining all of the Color products. Specifically designed for wall application needs in interior spaces, PRO Color wall tiles are produced modularly to fit 2 mm joint spaces. Moreover, in addition to 10x30 cm, 15x15 cm and 20x20 cm, 20x40 cm size option is also available in wall tile body for wall application needs.

Her mekânda modülerlik

Küçük bir evin banyosu ya da dev bir alışveriş merkezi, PRO Color'ın modüler yapısı farklı büyüklüklerde tasarımların bir bütünlük içinde hayata geçmesini sağlıyor. 2.5x2.5 cm'den 30x60 cm'ye 11 farklı boyutta porselen ve duvar karoları 3 mm'lik derz aralıklarına uygun olarak üretiliyor. Color'ın tüm ürünlerini sınırsız kombinasyonlarla kullanarak tasarımlarınızı gerçeğe dönüştürebilirsiniz. Duvar ve iç mekân kullanımına özel PRO Color duvar karoları 2 mm derze göre modüler olarak üretiliyor. Üstelik 10x30 cm, 15x15 cm ve 20x20 cm ebatlarına ek olarak sadece duvar kullanımı için 20x40 cm seçeneği de mevcut.

Made to stock for you

The most preferred tiles in different colors and sizes in Vitra PRO Color collection, are now kept in stock, ready for delivery as part of Vitra Color Stock Program. Through this program Vitra aims to serve to the needs of architects and interior designers on demand. Thus now you have the chance to use the wide range of colors and sizes of PRO Color collection, in your residential or commercial projects without worrying about delivery time. Please refer to the tables on pages 18-19 for products with * sign on Color product portfolio table to find the products under this program.

Sizin için hazır bekliyor

Vitra PRO Color koleksiyonunda en çok tercih edilen renk ve ebatlardaki karolar, mimarlara ve iç mimarlara anında hizmet verebilmek için şimdi Color Stok Programı dahilinde sevke hazır tutuluyor. Her türlü konut ve Ticari alan projesinde PRO Color seramik koleksiyonunun renk ve ebat zenginliğini, teslim zamanı endişesi olmaksızın tasarımlarınızda kullanabilirsiniz. Lütfen, stoklu ürünleri kontrol etmek için Sayfa 18-19'daki "PRO Color Ürün Gami" sayfalarında *li ürünlere bakınız.

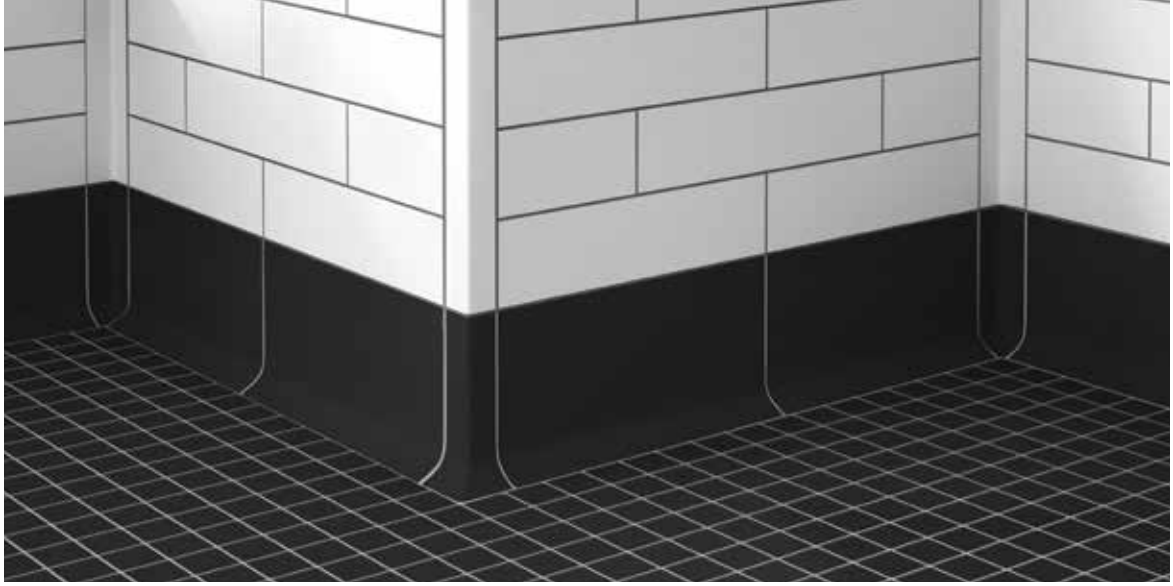

Complementary pieces

PRO Color complementary pieces provide covering solutions for edges and corners in 6 colors. These parts ensure aesthetic appearance and ease of cleaning and are very suitable for all kinds of wet areas such as bathrooms, kitchens and Industrial areas. Moreover, thanks to their modular structure, they can be used with all products available in PRO Color and PRO Function ranges.

Tamamlayıcı parçalar

PRO Color 6 renkte kenar ve köşe dönüşleri için kaplama çözümleri sunar. Estetiğin yanı sıra temizlik imkânı da sağlayan parçalar; hem banyo, mutfak gibi ıslak alanlarda hem de endüstriyel mekânlarda kullanıma uygundur. Üstelik modüler yapıları sayesinde PRO Function ve PRO Color ürünleriyle birlikte kullanılabilir.

Color



Basic



Aqua



Color

Porcelain and floor tiles / Porselen ve yer karoları

Matt, Glossy / Mat, Parlak

RAL code RAL kodu	Color group Renk grubu	PEI	2,5x2,5	5x5	10x10	10x20	10x30	12,5x25	15x15	20x20	30x30	30x60	
													Matt/Mat
RAL 9016	Basic	4	3	*		*		*		*		*	
RAL 0001500	Basic	2	2	*	*	*	*	*	*	*	*	*	*
RAL 1105050	Basic	3	2		*	*				*			
RAL 1008080	Basic	3	2		*	*				*			
RAL 0808060 Matt / Mat	Basic	3	3		*	*				*			
RAL 1018 Glossy / Parlak	Basic	3	3		*	*				*			
RAL 0757070	Basic	3	2		*	*				*			
RAL 2010 Glossy / Parlak	Basic	2	2		*	*				*			
RAL 2003 Matt / Mat	Basic	2	2		*	*				*			
RAL 3000 Glossy / Parlak	Basic	2	2		*	*				*		*	
RAL 0304050 Matt / Mat	Basic	2	2		*	*				*			
RAL 2008020	Aqua	3	2		*	*				*			
RAL 2006020	Aqua	3	2		*	*				*			
RAL 2004030	Aqua	2	2		*	*				*			
RAL 2307015	Aqua	4	3		*	*				*	*		
RAL 2306020	Aqua	3			*	*				*			
RAL 2404020	Aqua	2	2		*	*				*			
RAL 2606030	Aqua	3	2		*	*				*			
RAL 2603035	Aqua	2	2		*	*				*			
RAL 5002	Aqua	2	2		*	*				*	*		
RAL 1009005	Neutral	4	3		*	*				*			
RAL 0809005	Neutral	4	3	*	*	*	*	*	*	*	*	*	*
RAL 0809010	Neutral	4	3		*	*				*	*		
RAL 0808010	Neutral	4			*	*				*			
RAL 0958010	Neutral	4	3		*	*				*	*		
RAL 0007500	Neutral	3	2	*	*	*	*	*	*	*	*	*	*
RAL 0806005	Neutral	3	2		*	*				*			
RAL 0505010	Neutral	3	2		*	*				*			
RAL 7047	Neutral	4	3	*	*	*	*	*	*	*	*	*	*
RAL 0008000	Neutral	3			*	*				*	*		
RAL 0005500	Neutral	3	2	*	*	*	*	*	*	*	*	*	*
RAL 0004000	Neutral	2	2		*	*				*	*	*	
RAL 3004	Mood	2	2		*	*				*			
RAL 0504040	Mood	2	2		*	*				*			
RAL 0706040	Mood	3	2		*	*				*			
RAL 2904015	Mood	2	2		*	*				*			
RAL 0404005	Mood	2	2		*	*				*			
RAL 0606020	Mood	2	2		*	*				*			
RAL 0206005	Mood	3	2		*	*				*			
RAL 1007010	Mood	4	2		*	*				*			
RAL 2205005	Mood	2	2		*	*				*			

Colored cells are available in our sales portfolio.

Cells with (*) are the stock program products. M5x5cm, M10x10cm and M20x20cm all matt colors are available in stock. RAL0001500, RAL 9016, RAL 0005500, RAL 0007500, RAL 0809005, RAL 7047 matt colors have all sizes in stock from M2,5x2,5cm to M30x60cm.

Renklendirilmiş satırlar, satış hattımızda mevcuttur.

İçerisinde (*) olan satırlar stok programı ürünleridir. M5x5cm, M10x10cm ve M20x20cm ebadındaki tüm mat renkler stoklarımızda mevcuttur. M2,5x2,5 cm'den M30x60cm'ye kadar tüm ebatlar mat renklerde RAL 9016, RAL 0001500, RAL 0809005, RAL 0007500, RAL 7047 ve RAL 0005500 olarak stoklarımızda mevcuttur.

Porcelain and floor tiles / Porselen ve yer karoları

Slip Resistance / Kaymazlık

RAL code RAL kodu	Color group Renk grubu	2,5x2,5			5x5			10x10			10x20		12.5x25		15x15	20x20			30x30
		R10A	R10B	R10B	R9A	R10A	R10B	C	R10B	C	R10B	C	R10B	R9A	R10A	R10B	R10B		
<input type="checkbox"/> RAL 9016	Basic	<input type="checkbox"/>	<input type="checkbox"/>	<input type="checkbox"/>	<input type="checkbox"/>	<input type="checkbox"/>	<input type="checkbox"/>	<input type="checkbox"/>	<input type="checkbox"/>	<input type="checkbox"/>	<input type="checkbox"/>	<input type="checkbox"/>	<input type="checkbox"/>	<input type="checkbox"/>	<input type="checkbox"/>	<input type="checkbox"/>	<input type="checkbox"/>	<input type="checkbox"/>	
<input checked="" type="checkbox"/> RAL 0001500	Basic	<input checked="" type="checkbox"/>	<input type="checkbox"/>	<input checked="" type="checkbox"/>	<input type="checkbox"/>	<input type="checkbox"/>	<input type="checkbox"/>	<input checked="" type="checkbox"/>	<input checked="" type="checkbox"/>	<input checked="" type="checkbox"/>	<input type="checkbox"/>	<input checked="" type="checkbox"/>	<input checked="" type="checkbox"/>	<input type="checkbox"/>	<input type="checkbox"/>	<input type="checkbox"/>	<input type="checkbox"/>	<input type="checkbox"/>	
<input checked="" type="checkbox"/> RAL 0808060 Matt / Mat	Basic	<input checked="" type="checkbox"/>	<input type="checkbox"/>	<input type="checkbox"/>	<input type="checkbox"/>	<input type="checkbox"/>	<input type="checkbox"/>	<input type="checkbox"/>	<input type="checkbox"/>	<input type="checkbox"/>	<input type="checkbox"/>	<input type="checkbox"/>	<input type="checkbox"/>	<input type="checkbox"/>	<input type="checkbox"/>	<input type="checkbox"/>	<input type="checkbox"/>	<input type="checkbox"/>	
<input checked="" type="checkbox"/> RAL 2307015	Aqua	<input type="checkbox"/>	<input checked="" type="checkbox"/>	<input checked="" type="checkbox"/>	<input type="checkbox"/>	<input type="checkbox"/>	<input type="checkbox"/>	<input checked="" type="checkbox"/>	<input type="checkbox"/>	<input checked="" type="checkbox"/>	<input checked="" type="checkbox"/>	<input checked="" type="checkbox"/>	<input checked="" type="checkbox"/>	<input type="checkbox"/>	<input type="checkbox"/>	<input type="checkbox"/>	<input type="checkbox"/>	<input checked="" type="checkbox"/>	
<input checked="" type="checkbox"/> RAL 2606030	Aqua	<input type="checkbox"/>	<input type="checkbox"/>	<input type="checkbox"/>	<input type="checkbox"/>	<input type="checkbox"/>	<input type="checkbox"/>	<input checked="" type="checkbox"/>	<input checked="" type="checkbox"/>	<input checked="" type="checkbox"/>	<input checked="" type="checkbox"/>	<input checked="" type="checkbox"/>	<input checked="" type="checkbox"/>	<input type="checkbox"/>	<input type="checkbox"/>	<input type="checkbox"/>	<input type="checkbox"/>	<input type="checkbox"/>	
<input checked="" type="checkbox"/> RAL 2603035	Aqua	<input type="checkbox"/>	<input type="checkbox"/>	<input type="checkbox"/>	<input type="checkbox"/>	<input type="checkbox"/>	<input type="checkbox"/>	<input checked="" type="checkbox"/>	<input checked="" type="checkbox"/>	<input type="checkbox"/>	<input checked="" type="checkbox"/>	<input checked="" type="checkbox"/>	<input checked="" type="checkbox"/>	<input type="checkbox"/>	<input type="checkbox"/>	<input type="checkbox"/>	<input type="checkbox"/>	<input type="checkbox"/>	
<input checked="" type="checkbox"/> RAL 5002	Aqua	<input type="checkbox"/>	<input checked="" type="checkbox"/>	<input checked="" type="checkbox"/>	<input type="checkbox"/>	<input type="checkbox"/>	<input type="checkbox"/>	<input checked="" type="checkbox"/>	<input checked="" type="checkbox"/>	<input checked="" type="checkbox"/>	<input checked="" type="checkbox"/>	<input checked="" type="checkbox"/>	<input checked="" type="checkbox"/>	<input type="checkbox"/>	<input type="checkbox"/>	<input type="checkbox"/>	<input type="checkbox"/>	<input type="checkbox"/>	
<input checked="" type="checkbox"/> RAL 0809005	Neutral	<input type="checkbox"/>	<input type="checkbox"/>	<input checked="" type="checkbox"/>	<input type="checkbox"/>	<input type="checkbox"/>	<input type="checkbox"/>	<input type="checkbox"/>	<input type="checkbox"/>	<input type="checkbox"/>	<input type="checkbox"/>	<input type="checkbox"/>	<input type="checkbox"/>	<input type="checkbox"/>	<input type="checkbox"/>	<input type="checkbox"/>	<input checked="" type="checkbox"/>	<input type="checkbox"/>	
<input checked="" type="checkbox"/> RAL 0809010	Neutral	<input type="checkbox"/>	<input type="checkbox"/>	<input checked="" type="checkbox"/>	<input type="checkbox"/>	<input type="checkbox"/>	<input type="checkbox"/>	<input checked="" type="checkbox"/>	<input type="checkbox"/>	<input type="checkbox"/>	<input type="checkbox"/>	<input type="checkbox"/>	<input checked="" type="checkbox"/>	<input type="checkbox"/>	<input type="checkbox"/>	<input type="checkbox"/>	<input checked="" type="checkbox"/>	<input checked="" type="checkbox"/>	
<input checked="" type="checkbox"/> RAL 0007500	Neutral	<input checked="" type="checkbox"/>	<input type="checkbox"/>	<input checked="" type="checkbox"/>	<input checked="" type="checkbox"/>	<input checked="" type="checkbox"/>	<input checked="" type="checkbox"/>	<input checked="" type="checkbox"/>	<input checked="" type="checkbox"/>	<input checked="" type="checkbox"/>	<input checked="" type="checkbox"/>	<input checked="" type="checkbox"/>	<input checked="" type="checkbox"/>	<input checked="" type="checkbox"/>	<input checked="" type="checkbox"/>	<input checked="" type="checkbox"/>	<input checked="" type="checkbox"/>	<input checked="" type="checkbox"/>	
<input checked="" type="checkbox"/> RAL 7047	Neutral	<input type="checkbox"/>	<input type="checkbox"/>	<input checked="" type="checkbox"/>	<input type="checkbox"/>	<input type="checkbox"/>	<input type="checkbox"/>	<input checked="" type="checkbox"/>	<input checked="" type="checkbox"/>	<input checked="" type="checkbox"/>	<input checked="" type="checkbox"/>	<input checked="" type="checkbox"/>	<input checked="" type="checkbox"/>	<input checked="" type="checkbox"/>	<input checked="" type="checkbox"/>	<input checked="" type="checkbox"/>	<input checked="" type="checkbox"/>	<input checked="" type="checkbox"/>	
<input checked="" type="checkbox"/> RAL 0005500	Neutral	<input type="checkbox"/>	<input type="checkbox"/>	<input checked="" type="checkbox"/>	<input type="checkbox"/>	<input type="checkbox"/>	<input type="checkbox"/>	<input checked="" type="checkbox"/>	<input type="checkbox"/>	<input type="checkbox"/>	<input type="checkbox"/>	<input type="checkbox"/>	<input type="checkbox"/>	<input type="checkbox"/>	<input type="checkbox"/>	<input type="checkbox"/>	<input type="checkbox"/>	<input checked="" type="checkbox"/>	
<input checked="" type="checkbox"/> RAL 0004000	Neutral	<input type="checkbox"/>	<input type="checkbox"/>	<input checked="" type="checkbox"/>	<input type="checkbox"/>	<input type="checkbox"/>	<input type="checkbox"/>	<input checked="" type="checkbox"/>	<input type="checkbox"/>	<input type="checkbox"/>	<input type="checkbox"/>	<input type="checkbox"/>	<input type="checkbox"/>	<input type="checkbox"/>	<input type="checkbox"/>	<input type="checkbox"/>	<input type="checkbox"/>	<input type="checkbox"/>	

Colored cells are available in our sales portfolio.

Renklendirilmiş satırlar, satış hattımızda mevcuttur.

Wall tiles / Duvar karoları

Matt, Glossy / Mat, Parlak

RAL code RAL kodu	Color group Renk grubu	10x30		15x15		20x20		20x40	
		Matt / Mat	Glossy / Parlak	Matt / Mat	Glossy / Parlak	Matt / Mat	Glossy / Parlak	Matt / Mat	Glossy / Parlak
<input type="checkbox"/> RAL 9016	Basic	<input type="checkbox"/>	<input type="checkbox"/>	<input type="checkbox"/>	<input type="checkbox"/>	<input type="checkbox"/>	<input type="checkbox"/>	<input type="checkbox"/>	<input type="checkbox"/>
<input checked="" type="checkbox"/> RAL 0001500	Basic	<input checked="" type="checkbox"/>	<input type="checkbox"/>	<input type="checkbox"/>	<input type="checkbox"/>	<input type="checkbox"/>	<input type="checkbox"/>	<input type="checkbox"/>	<input type="checkbox"/>
<input checked="" type="checkbox"/> RAL 1009005	Neutral	<input checked="" type="checkbox"/>	<input checked="" type="checkbox"/>	<input type="checkbox"/>	<input type="checkbox"/>	<input type="checkbox"/>	<input type="checkbox"/>	<input type="checkbox"/>	<input type="checkbox"/>
<input checked="" type="checkbox"/> RAL 0809010	Neutral	<input type="checkbox"/>	<input type="checkbox"/>	<input checked="" type="checkbox"/>	<input type="checkbox"/>	<input type="checkbox"/>	<input type="checkbox"/>	<input type="checkbox"/>	<input type="checkbox"/>
<input checked="" type="checkbox"/> RAL 0958010	Neutral	<input checked="" type="checkbox"/>	<input checked="" type="checkbox"/>	<input type="checkbox"/>	<input type="checkbox"/>	<input type="checkbox"/>	<input type="checkbox"/>	<input type="checkbox"/>	<input type="checkbox"/>
<input checked="" type="checkbox"/> RAL 0007500	Neutral	<input checked="" type="checkbox"/>	<input checked="" type="checkbox"/>	<input type="checkbox"/>	<input type="checkbox"/>	<input type="checkbox"/>	<input type="checkbox"/>	<input type="checkbox"/>	<input type="checkbox"/>
<input checked="" type="checkbox"/> RAL 7047	Neutral	<input checked="" type="checkbox"/>	<input checked="" type="checkbox"/>	<input checked="" type="checkbox"/>	<input checked="" type="checkbox"/>	<input checked="" type="checkbox"/>	<input checked="" type="checkbox"/>	<input checked="" type="checkbox"/>	<input checked="" type="checkbox"/>
<input checked="" type="checkbox"/> RAL 0008000	Neutral	<input checked="" type="checkbox"/>	<input type="checkbox"/>	<input type="checkbox"/>	<input type="checkbox"/>	<input type="checkbox"/>	<input type="checkbox"/>	<input type="checkbox"/>	<input type="checkbox"/>
<input checked="" type="checkbox"/> RAL 0005500	Neutral	<input checked="" type="checkbox"/>	<input type="checkbox"/>	<input type="checkbox"/>	<input type="checkbox"/>	<input type="checkbox"/>	<input type="checkbox"/>	<input type="checkbox"/>	<input type="checkbox"/>

Colored cells are available in our sales portfolio.

Renklendirilmiş satırlar, satış hattımızda mevcuttur.

Color

Basic



K53420080001VTE0 10x10 Basic RAL 0304050
K50797580001VTE0 10x10 Basic RAL 0001500
K50792080001VTE0 10x10 Basic RAL 9016



Color

Basic



PRO

Technic

Basic

Basic welcomes you to the world of lively colors of a rainbow with red tones known for energizing spaces, blue tones for giving peaceful feel of a blue sky and green tones for adding a fresh feel in our lives. Basic is an ideal choice for creating lively and vivid spaces with its different size and tone alternatives making it the perfect solution for both commercial and residential spaces.

Her ortama enerji veren kırmızılar, gökyüzünün sonsuz huzurunu hissettiren maviler, hayata tazelik katan yeşiller ve gökkuşağının enerjisiyle parlaklığını mekânlara taşıyan daha pek çok temel rengi Basic'te bulabilirsiniz. Farklı ebat ve ton alternatifleriyle hem ticari mekân hem de ev kullanımları için birbirinden renkli döşeme seçenekleri sunan Basic ile siz de canlı ve hayat dolu mekânlar yaratabilirsiniz.

Porcelain tiles / Porselen karolar

Ceramic floor tiles / Seramik yer karoları

Wall tiles / Duvar karoları

Surface alternatives / Yüzeysel alternatifleri

Matt / Mat

Glossy / Parlak

R9A

R10A

R10B

C

Porcelain and ceramic floor tiles sizes / Porselen ve seramik yer karosu ebatları

M2,5x2,5 cm (23x23x6 mm)

M5x5 cm (47x47x6 mm)

M10x10 cm (97x97x6 mm)

M10x20 cm (97x197x6 mm)

M10x30 cm (97x297x6 mm)

M15x15 cm (147x147x6 mm)

M20x20 cm (197x197x6 mm)

M30x30 cm (297x297x7 mm)

M30x60 cm (297x597x9 mm)

Wall tiles sizes / Duvar karosu ebatları

M10x30 cm (98x298x7,5 mm)

M15x15 cm (148x148x6 mm)

M20x20 cm (198x198x6 mm)

M20x40 cm (198x398x7 mm)

Base tile colors / Fon renkleri

White / Beyaz, RAL 9016

Black / Siyah, RAL 0001500

Green / Yeşil, RAL 1105050

Lime green / Limon yeşili, RAL 1008080

Yellow / Sarı, RAL 0808060 (Matt / Mat),

RAL 1018 (Glossy / Parlak)

Dark yellow / Koyu sarı, RAL 0757070

Orange / Turuncu, RAL 2003 (Matt / Mat),

RAL 2010 (Glossy / Parlak)

Red / Kırmızı, RAL 0304050 (Matt / Mat),

RAL 3000 (Glossy / Parlak)

Usage areas / Kullanım alanları

Residential / Konut

Commercial / Ticari alan

Tiling areas / Döşeme alanları

Floor / Yer

Wall / Duvar

Frost resistance / Dona dayanım

Available / Var

Shade variation classification / Desen farklılaşması

Vo

Product standard / Ürün standardı

EN14411 Group Bla:

Porcelain tiles / Porselen karolar

EN14411 Group Blb:

Ceramic floor tiles / Seramik yer karoları

EN14411 Group BlII:

Wall tiles / Duvar karoları



Porcelain
Porselen



Floor tile
Yer karosu



Wall tile
Duvar karosu



Residential
Konut



Commercial
Ticari alan



Pool surrounding
Havuz çevresi



Frost resistance
Dona dayanım



Shade variation
Desen farklılaşması



Matt
Mat



Glossy
Parlak



Non-rectified
Rektifiyesiz



Modularity
Modülerlik

Color

Basic



K53420080001VTEO 10x10 Basic RAL 0304050
K50797580001VTEO 10x10 Basic RAL 0001500
K50792080001VTEO 10x10 Basic RAL 9016



RAL 9016



RAL 0001500



RAL 1105050



RAL 1008080



RAL 0808060
Matt / Mat
RAL 1018
Glossy / Parlak



RAL 0757070



RAL 2003
Matt / Mat
RAL 2010
Glossy / Parlak



RAL 0304050
Matt / Mat
RAL 3000
Glossy / Parlak

Color

Aqua



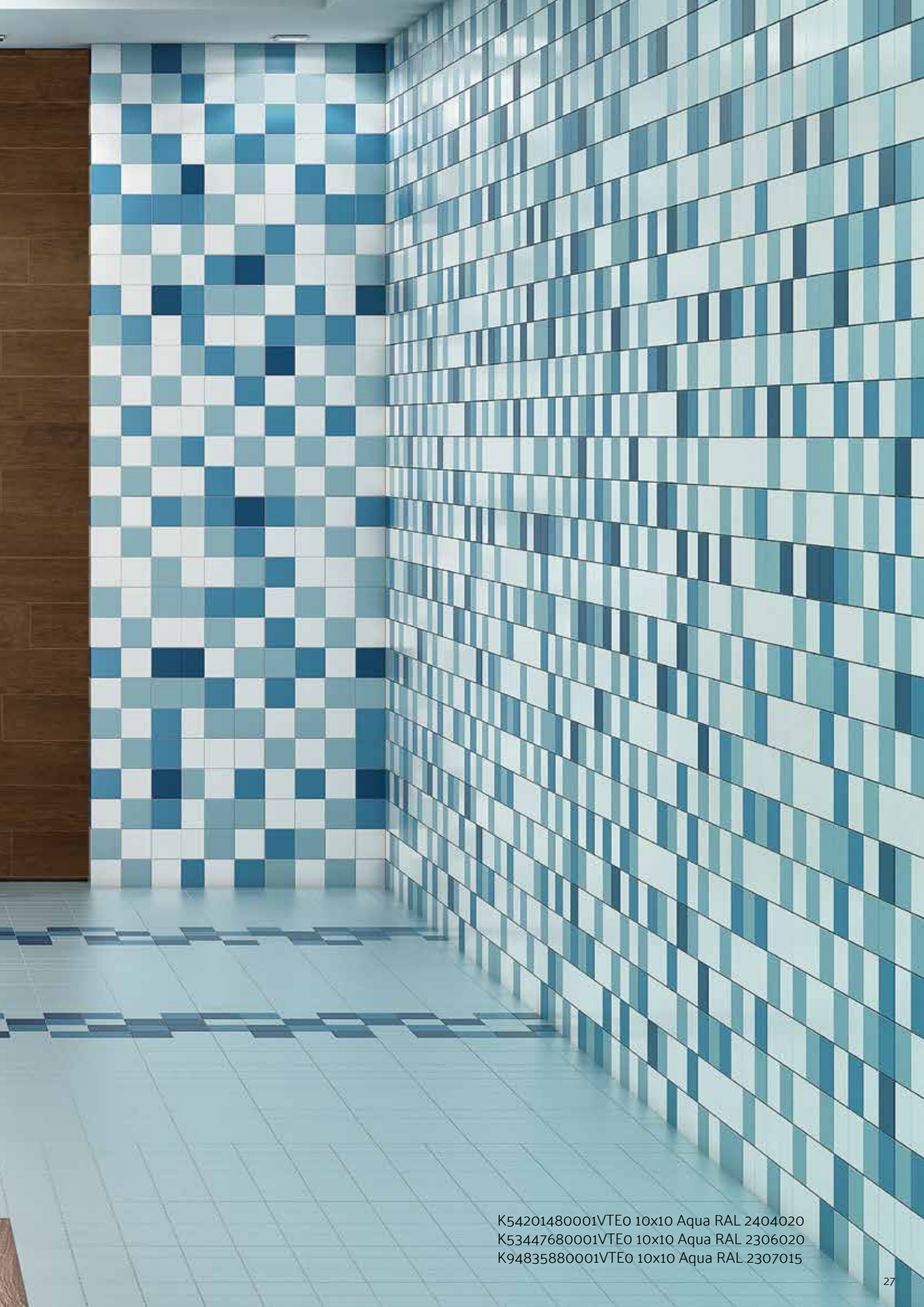

K54201480001VTE0 10x10 Aqua RAL 2404020
K53447680001VTE0 10x10 Aqua RAL 2306020
K94835880001VTE0 10x10 Aqua RAL 2307015

Color

Aqua



PRO

Technic

Aqua

Enhancing the relaxing effect of water with the use of various shades of blue and turquoise, color transitions and white and black, in mix&match options with varying sizes, Aqua is especially ideal for pools and spa centers. Aqua offers hygienic, reliable and aesthetic tiling solutions for modern spaces where water meets architecture. The series combines the vitality of water with long-term durability of tiles.

Suyun rahatlatıcı etkisini güçlendiren ve özellikle havuz ya da spa alanları için tercih edilen mavi ve turkuazın tonlarını, renk geçişlerini, beyaz ve siyahın farklı ebat alternatifleriyle kombinasyonlarını Aqua'da bulabilirsiniz. Aqua size su ile mimarinin bulunduğu farklı mekânlar için hijyenik, güvenli ve estetik bir kaplama çözümü sunuyor. Suyun hayat veren canlılığını karonun uzun ömürlü dayanıklılığıyla birleştiriyor.

Porcelain tiles / Porselen karolar

Ceramic floor tiles / Seramik yer karoları

Surface alternatives / Yüzey alternatifleri

Matt / Mat
Glossy / Parlak
R10A
R10B
C

Porcelain and ceramic floor tiles sizes / Porselen ve seramik yer karosu ebatları

M2,5x2,5 cm (23x23x6 mm)
M5x5 cm (47x47x6 mm)
M10x10 cm (97x97x6 mm)
M10x20 cm (97x197x6 mm)
M10x30 cm (97x297x6 mm)
M15x15 cm (147x147x6 mm)
M20x20 cm (197x197x6 mm)
M30x30 cm (297x297x7 mm)

Base tile colors / Fon renkleri

Calipso / Cam göbeği, RAL 2008020
Turquoise / Turkuaz, RAL 2006020
Dark turquoise / Koyu turkuaz, RAL 2004030
Pool blue / Havuz mavisi, RAL 2307015
Blue / Mavi, RAL 2306020
Ocean blue / Okyanus mavisi, RAL 2404020
Cool blue / Soğuk mavi, RAL 2606030
Aqua blue / Göl mavisi, RAL 2603035
Cobalt blue / Kobalt mavi, RAL 5002

Usage areas / Kullanım alanları

Residential / Konut
Commercial / Ticari alan

Tiling areas / Döşeme alanları

Floor / Yer
Wall / Duvar

Frost resistance / Dona dayanım

Available / Var

Shade variation classification / Desen farklılaşması

V0

Product standard / Ürün standardı

EN14411 Group BlA:
Porcelain tiles / Porselen karolar
EN14411 Group BlB:
Ceramic floor tiles / Seramik yer karoları



Porcelain
Porselen



Floor tile
Yer karosu



Wall tile
Duvar karosu



Residential
Konut



Commercial
Ticari alan



Pool surrounding
Havuz çevresi



Frost resistance
Dona dayanım



Shade variation
Desen farklılaşması



Matt
Mat



Glossy
Parlak



Non-rectified
Rektifiyesiz



Modularity
Modülerlik

Color

Aqua



K54201480001VTE0 10x10 Aqua RAL 2404020
K53447680001VTE0 10x10 Aqua RAL 2306020
K94835880001VTE0 10x10 Aqua RAL 2307015

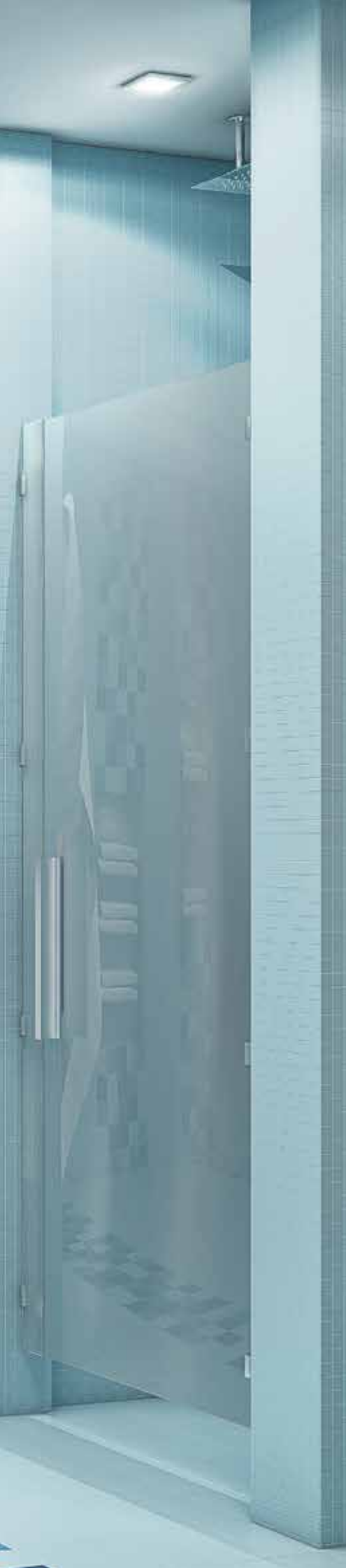

RAL 2008020



RAL 2006020



RAL 2004030



RAL 2307015



RAL 2306020



RAL 2404020



RAL 2606030



RAL 2603035



RAL 5002

Color

Neutral





K76899500001VTE0 30x30 Neutral RAL 0809010
K83808000001VTE0 10x30 Neutral RAL 0809010
K54213200001VTE0 10x30 Neutral RAL 0958010
K79397600001VTE0 10x30 Neutral RAL 0007500

Color

Neutral



PRO

Technic

Porcelain tiles / Porselen karolar

Ceramic floor tiles / Seramik yer karoları

Wall tiles / Duvar karoları

Surface alternatives / Yüzey alternatifleri

Matt / Mat

Glossy / Parlak

R9A

R10A

R10B

C

**Porcelain and ceramic floor tiles sizes /
Porselen ve seramik yer karosu ebatları**

M2,5x2,5 cm (23x23x6 mm)

M5x5 cm (47x47x6 mm)

M10x10 cm (97x97x6 mm)

M10x20 cm (97x197x6 mm)

M12,5x25 cm (119x244x6,5 mm)

M10x30 cm (97x297x6 mm)

M15x15 cm (147x147x6 mm)

M20x20 cm (197x197x6 mm)

M30x30 cm (297x297x7 mm)

M30x60 cm (297x597x9 mm)

Wall tiles sizes / Duvar karosu ebatları

M10x30 cm (98x298x7,5 mm)

M15x15 cm (148x148x6 mm)

M20x20 cm (198x198x6 mm)

Base tile colors / Fon renkleri

Ultra white / Ultra beyaz, Ral 1009005

Cream / Krem, Ral 0809005

Light sand / Açık kum beji, Ral 0809010

Sand / Kum beji, Ral 0808010

Light mink / Açık vizon, Ral 0958010

Greige / Grej, Ral 0007500

Dark greige / Koyu grej, Ral 0806005

Dark mink / Koyu vizon, Ral 0505010

Light grey / Açık gri, RAL 7047

Grey / Gri, Ral 0008000

Dark grey / Koyu gri, Ral 0005500

Anthracite / Antrasit, Ral 0004000

Usage areas / Kullanım alanları

Residential / Konut

Commercial / Ticari alan

Tiling areas / Döşeme alanları

Floor / Yer

Wall / Duvar

Frost resistance / Dona dayanım

Available / Var

**Shade variation classification /
Desen farklılaşması**

VO

Product standard / Ürün standardı

EN14411 Group BIa:

Porcelain tiles / Porselen karolar

EN14411 Group BIb:

Ceramic floor tiles / Seramik yer karoları

EN14411 Group BIll: Wall tiles / Duvar karoları

Neutral

Neutral offers special tiling alternatives for all commercial spaces including shopping malls, airports, office buildings and manufacturing facilities with its selected shades of beige and grey. Neutral color palette provides safe and reliable solutions for commercial and industrial areas which is an ideal offering for the needs of design in these spaces.

Neutral, özel geliştirilmiş bej ve gri tonlarıyla alışveriş merkezleri, havaalanları, ofis binaları ve üretim tesisleri dahil tüm ticari alanlar için özel kaplama seçenekleri sunar. Ticari binaların temel işlevsellik gereksinimlerini karşılamak için güvenilir çözümler sunan Neutral renk paleti, ticari ve endüstriyel mekân tasarımları için ideal alternatifler içerir.



Porcelain
Porselen



Floor tile
Yer karosu



Wall tile
Duvar karosu



Residential
Konut



Commercial
Ticari alan



Pool surrounding
Havuz çevresi



Frost resistance
Dona dayanım



Shade variation
Desen farklılaşması



Matt
Mat



Glossy
Parlak



Non-rectified
Rektifiyesiz



Modularity
Modülerlik

Color

Neutral



K76899500001VTE0 30x30 Neutral RAL 0809010
K83808000001VTE0 10x30 Neutral RAL 0809010
K54213200001VTE0 10x30 Neutral RAL 0958010
K79397600001VTE0 10x30 Neutral RAL 0007500

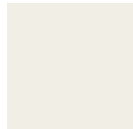

RAL 1009005

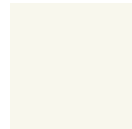

RAL 0809005



RAL 0809010

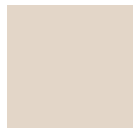

RAL 0808010



RAL 0958010



RAL 0007500



RAL 0806005



RAL 0505010

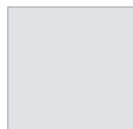

RAL 7047

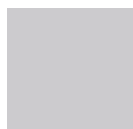

RAL 0008000



RAL 0005500



RAL 0004000

Color

Mood



BREAKFAST

OMLET
FRENCH FRIES 45
BREAD
ORANGE JUICE

BACON WITH EGGS
FRENCH FRIES 45
BREAD
ORANGE JUICE

CROISSANT
COFFE OR TEA 35
ORANGE JUICE

JAM, BUTTER, HONEY
COFFE OR TEA 45
BREAD OR TOAST

PRIMI e SECONDI (M)

RAVIOLI di BURRATA
"HOME MADE RAVIOLI W. BURRATA
SERVED W. SUN-DRIED-TOM & BASIL"

LINGUINE CAPESANTE e FIORI
"LINGUINE PASTA SERVED W. FRESH
ZUCCHINI FLOWERS & TOUCH OF CAPERS"

SALMONE GRATINATO
"OREN BAKED SALMON FLUET W. SAUCE"



AINS)
26.00
FILLING
PESTO
25.00
SCHWOPS
CREAM.
26.00
WITH

K54172380001VTE0 10x10 Mood RAL 1007010
K54167580001VTE0 10x10 Mood RAL 2205005
K54169080001VTE0 10x10 Mood RAL 2904015
K54168680001VTE0 10x10 Mood RAL 0706040

Color

Mood



K54166480001VTEo 10x10 Mood RAL 0606020
K54171280001VTEo 10x10 Mood RAL 0206005
K54172380001VTEo 10x10 Mood RAL 1007010



K79971100001VTEo 10x30 Mood RAL 3004
K50792080001VTEo 10X10 Basic RAL 9016

Color

Mood



PRO

Technic

Porcelain tiles / Porselen karolar Ceramic floor tiles / Seramik yer karoları

Surface alternatives / Yüzey alternatifleri

Matt / Mat
Glossy / Parlak

Porcelain and ceramic floor tiles sizes / Porselen ve seramik yer karosu ebatları

M2,5x2,5 cm (23x23x6 mm)
M5x5 cm (47x47x6 mm)
M10x10 cm (97x97x6 mm)
M10x30 cm (97x297x6 mm)
M20x20 cm (197x197x6 mm)

Base tile colors / Fon renkleri

Burgundy / Bordo, RAL 3004
Tobacco / Taba, RAL 0504040
Ochre yellow / Toprak sarısı, RAL 0706040
Plum / Mürdüm, RAL 2904015
Basalt brown / Bazalt kahve, RAL 0404005
Soft brown / Tatlı kahve, RAL 0606020
Whisper lilac / Leylak, RAL 0206005
Light khaki / Açık haki, RAL 1007010
Prussian blue / Prusya mavisi, RAL 2205005

Usage areas / Kullanım alanları

Residential / Konut
Commercial / Ticari alan

Tiling areas / Döşeme alanları

Floor / Yer
Wall / Duvar

Frost resistance / Dona dayanım

Available / Var

Shade variation classification / Desen farklılaşması

Vo

Product standard / Ürün standardı

EN14411 Group BlA:
Porcelain tiles / Porselen karolar
EN14411 Group BlB:
Ceramic floor tiles / Seramik yer karoları

Mood

Inspired by timeless and contemporary color trends, Mood invites you to the world of distinguished colors of any season. Combining modularity and reliability of PRO collections with trendy colors, Mood adds a distinctive taste to modern spaces with functional tiling requirements.

Güncel trendlerden ve moda renklerden ilhamını alan Mood ile farklı atmosferler ve modern mekânlar yaratabilirsiniz. PRO koleksiyonlarının modüler döşeme avantajını son moda renklerle birlikte sunan Mood, hem fonksiyonel kaplama ihtiyaçlarının güvenilir bir şekilde çözümünü hem de mekânların ilham veren tasarımlarla en zevkli şekilde farklılaşmasını sağlıyor.



Color

Mood



BREAKFAST	
OMLET	45
FRENCH FRIES	
DREAD	
ORANGE JUICE	

BACON WITH EGGS	45
FRENCH FRIES	
DREAD	
ORANGE JUICE	

CROISSANT	35
COFFE OR TEA	
ORANGE JUICE	

JAM, BUTTER, HONEY	45
COFFE OR TEA	
ORANGE JUICE	

K54172380001VTEo 10x10 Mood RAL 1007010
K54167580001VTEo 10x10 Mood RAL 2205005
K54169080001VTEo 10x10 Mood RAL 2904015
K54168680001VTEo 10x10 Mood RAL 0706040



RAL 3004



RAL 0504040



RAL 0706040



RAL 2904015



RAL 0404005



RAL 0606020



RAL 0206005



RAL 1007010



RAL 2205005

Color

Basic



White
Beyaz
RAL 9016
(Matt / Mat) PEI 4
RAL 9016
(Glossy / Parlak) PEI 3



Black
Siyah
RAL 0001500
(Matt / Mat) PEI 2
RAL 0001500
(Glossy / Parlak) PEI 2



Green
Yeşil
RAL 1105050
(Matt / Mat) PEI 3
RAL 1105050
(Glossy / Parlak) PEI 2



Lime green
Limon yeşili
RAL 1008080
(Matt / Mat) PEI 3
RAL 1008080
(Glossy / Parlak) PEI 2



Yellow
Sarı
RAL 0808060
(Matt / Mat) PEI 3
RAL 1018
(Glossy / Parlak) PEI 3



Dark yellow
Koyu sarı
RAL 0757070
(Matt / Mat) PEI 3
RAL 0757070
(Glossy / Parlak) PEI 2



Orange
Turuncu
RAL 2003
(Matt / Mat) PEI 2
RAL 2010
(Glossy / Parlak) PEI 2



Red
Kırmızı
RAL 0304050
(Matt / Mat) PEI 2
RAL 3000
(Glossy / Parlak) PEI 2

Aqua



Calipso
Cam göbeği
RAL 2008020
(Matt / Mat) PEI 3
RAL 2008020
(Glossy / Parlak) PEI 2



Turquoise
Turkuaz
RAL 2006020
(Matt / Mat) PEI 3
RAL 2006020
(Glossy / Parlak) PEI 2



Dark turquoise
Koyu turkuaz
RAL 2004030
(Matt / Mat) PEI 2
RAL 2004030
(Glossy / Parlak) PEI 2



Pool blue
Havuz mavisi
RAL 2307015
(Matt / Mat) PEI 4
RAL 2307015
(Glossy / Parlak) PEI 3



Blue
Mavi
RAL 2306020
(Matt / Mat) PEI 3



Ocean blue
Okyanus mavisi
RAL 2404020
(Matt / Mat) PEI 2
RAL 2404020
(Glossy / Parlak) PEI 2



Cool blue
Soğuk mavi
RAL 2606030
(Matt / Mat) PEI 3
RAL 2606030
(Glossy / Parlak) PEI 2



Aqua blue
Göl mavisi
RAL 2603035
(Matt / Mat) PEI 2
RAL 2603035
(Glossy / Parlak) PEI 2



Cobalt blue
Kobalt mavi
RAL 5002
(Matt / Mat) PEI 2
RAL 5002
(Glossy / Parlak) PEI 2

Color options overview Renk seçeneklerine genel bakış

Neutral

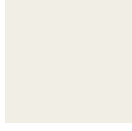

Ultra white
Ultra beyaz
RAL 1009005
(Matt / Mat) PEI 4
RAL 1009005
(Glossy / Parlak) PEI 3

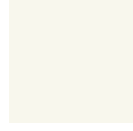

Cream
Krem
RAL 0809005
(Matt / Mat) PEI 4
RAL 0809005
(Glossy / Parlak) PEI 3



Light sand
Açık kum beji
RAL 0809010
(Matt / Mat) PEI 4
RAL 0809010
(Glossy / Parlak) PEI 3



Sand
Kum Beji
RAL 0808010
(Matt / Mat) PEI 4



Light mink
Açık vizon
RAL 0958010
(Matt / Mat) PEI 4
RAL 0958010
(Glossy / Parlak) PEI 3



Greige
Grej
RAL 0007500
(Matt / Mat) PEI 3
RAL 0007500
(Glossy / Parlak) PEI 2



Dark greige
Koyu grej
RAL 0806005
(Matt / Mat) PEI 3
RAL 0806005
(Glossy / Parlak) PEI 2



Dark mink
Koyu vizon
RAL 0505010
(Matt / Mat) PEI 3
RAL 0505010
(Glossy / Parlak) PEI 2



Light grey
Açık gri
RAL 7047
(Matt / Mat) PEI 4
RAL 7047
(Glossy / Parlak) PEI 3



Grey
Gri
RAL 0008000
(Matt / Mat) PEI 3



Dark grey
Koyu gri
RAL 0005500
(Matt / Mat) PEI 3
RAL 0005500
(Glossy / Parlak) PEI 2



Anthracite
Antrasit
RAL 0004000
(Matt / Mat) PEI 2
RAL 0004000
(Glossy / Parlak) PEI 2

Mood



Burgundy
Bordo
RAL 3004
(Matt / Mat) PEI 2
RAL 3004
(Glossy / Parlak) PEI 2



Tobacco
Taba
RAL 0504040
(Matt / Mat) PEI 2
RAL 0504040
(Glossy / Parlak) PEI 2



Ochre yellow
Toprak sarısı
RAL 0706040
(Matt / Mat) PEI 3
RAL 0706040
(Glossy / Parlak) PEI 2



Plum
Mürdüm
RAL 2904015
(Matt / Mat) PEI 2
RAL 2904015
(Glossy / Parlak) PEI 2



Basalt brown
Bazalt kahve
RAL 0404005
(Matt / Mat) PEI 2
RAL 0404005
(Glossy / Parlak) PEI 2



Soft brown
Tatlı kahve
RAL 0606020
(Matt / Mat) PEI 2
RAL 0606020
(Glossy / Parlak) PEI 2



Whisper lilac
Leylak
RAL 0206005
(Matt / Mat) PEI 3
RAL 0206005
(Glossy / Parlak) PEI 2



Light khaki
Açık haki
RAL 1007010
(Matt / Mat) PEI 4
RAL 1007010
(Glossy / Parlak) PEI 2



Prussian blue
Prusya mavisi
RAL 2205005
(Matt / Mat) PEI 2
RAL 2205005
(Glossy / Parlak) PEI 2

Color

Glazed porcelain tiles
Sırlı porselen karolar



Porcelain
Porselen



Frost resistance
Dona dayanım



Matt
Mat



Glossy
Parlak



Non-rectified
Rektifiyesiz

M 2,5 x 2,5 cm / 1" x 1"
23 x 23 x 6 mm
EN14411 Bla

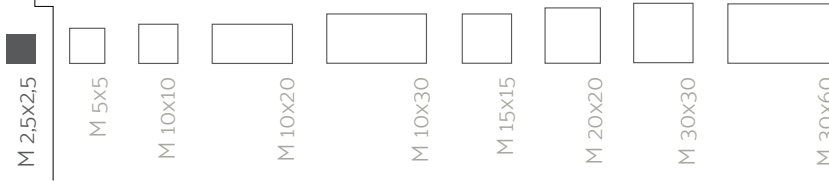

Basic



RAL 9016
Matt / Mat
K02770380001VTE0
Glossy / Parlak
K02771480001VTE0
R10B / R10B
K52873680001VTE0



RAL 0001500
Matt / Mat
K02765580001VTE0
Glossy / Parlak
K02766680001VTE0
R10A / R10A
K54054480001VTE0
R10B / R10B
K53384680001VTE0



RAL 1105050
Matt / Mat
K54223580001VTE0
Glossy / Parlak
K54225080001VTE0



RAL 1008080
Matt / Mat
K54222480001VTE0
Glossy / Parlak
K54224680001VTE0



RAL 0808060
Matt / Mat
K53371080001VTE0
R10A / R10A
K54056680001VTE0
RAL 1018
Glossy / Parlak
K02761180001VTE0



RAL 0757070
Matt / Mat
K53524680001VTE0



RAL 2003
Matt / Mat
K52046580001VTE0
RAL 2010
Glossy / Parlak
K52945180001VTE0



RAL 0304050
Matt / Mat
K52679180001VTE0
RAL 3000
Glossy / Parlak
K52642680001VTE0

Aqua



RAL 2008020
Matt / Mat
K02788080001VTE0
Glossy / Parlak
K02787680001VTE0



RAL 2006020
Matt / Mat
K54194480001VTE0
Glossy / Parlak
K54196680001VTE0



RAL 2004030
Matt / Mat
K53527280001VTE0
Glossy / Parlak
K53727680001VTE0



RAL 2307015
Matt / Mat
K02789180001VTE0
Glossy / Parlak
K02790280001VTE0
R10B / R10B
K52958080001VTE0



RAL 2306020
Matt / Mat
K53530580001VTE0



RAL 2404020
Matt / Mat
K54193380001VTE0
Glossy / Parlak
K54195580001VTE0



RAL 2606030
Matt / Mat
K02793580001VTE0
Glossy / Parlak
K02792480001VTE0



RAL 2603035
Matt / Mat
K51714280001VTE0
Glossy / Parlak
K02791380001VTE0



RAL 5002
Matt / Mat
K02764480001VTE0
Glossy / Parlak
K02763380001VTE0
R10B/R10B
K53058280001VTE0

Neutral

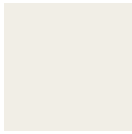

RAL 1009005
Matt / Mat
K52758380001VTE0
Glossy / Parlak
K53382480001VTE0

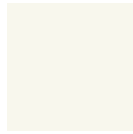

RAL 0809005
Matt / Mat
K02775180001VTE0
Glossy / Parlak
K02776280001VTE0



RAL 0808010
Matt / Mat
K52757280001VTE0



RAL 0958010
Matt / Mat
K02779580001VTE0
Glossy / Parlak
K02780680001VTE0



RAL 0007500
Matt / Mat
K02767080001VTE0
Glossy / Parlak
K02975580001VTE0
R10A / R10A
K54053380001VTE0
R10B / R10B
K53541280001VTE0

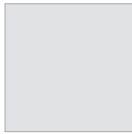

RAL 7047
Matt / Mat
K02768180001VTE0
Glossy / Parlak
K02769280001VTE0
R10B / R10B
K53217080001VTE0



RAL 0008000
Matt / Mat
K53361480001VTE0



RAL 0005500
Matt / Mat
K02900080001VTE0
Glossy / Parlak
K02901180001VTE0



RAL 0004000
Matt / Mat
K51548480001VTE0
Glossy / Parlak
K52278680001VTE0

Mood



RAL 3004
Matt / Mat
K02950180001VTE0

Color

Floor tiles Yer karoları



Floor tile
Yer karosu



Frost resistance
Dona dayanım



Matt
Mat



Glossy
Parlak



Non-rectified
Rektifiyesiz

* ■ M 5 x 5 cm / 2" x 2"
47 x 47 x 6 mm
EN14411 Blb

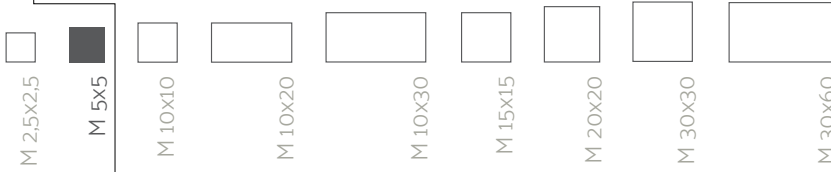

Basic



RAL 9016

Matt / Mat
K50488480001VTE0
Glossy / Parlak
K50560680001VTE0
R10B / R10B
K50500280001VTE0



RAL 0001500

Matt / Mat
K50498080001VTE0
Glossy / Parlak
K50565480001VTE0
R10B / R10B
K52360480001VTE0



RAL 1105050

Matt / Mat
K54227280001VTE0
Glossy / Parlak
K54229480001VTE0



RAL 1008080

Matt / Mat
K54226180001VTE0
Glossy / Parlak
K54228380001VTE0



RAL 0808060

Matt / Mat
K53400180001VTE0
RAL 1018
Glossy / Parlak
K50495480001VTE0



RAL 0757070

Matt / Mat
K94697080001VTE0



RAL 2003

Matt / Mat
K94695680001VTE0

RAL 2010

Glossy / Parlak
K52946280001VTE0



RAL 0304050

Matt / Mat
K52681380001VTE0

RAL 3000

Glossy / Parlak
K52643080001VTE0

Aqua



RAL 2008020

Matt / Mat
K50594580001VTE0
Glossy / Parlak
K02829680001VTE0



RAL 2006020

Matt / Mat
K54198180001VTE0
Glossy / Parlak
K54200380001VTE0



RAL 2004030

Matt / Mat
K94695780001VTE0



RAL 2307015

Matt / Mat
K50497680001VTE0
Glossy / Parlak
K50564380001VTE0
R10B / R10B
K50502480001VTE0



RAL 2306020

Matt / Mat
K94695880001VTE0



RAL 2404020

Matt / Mat
K54197080001VTE0
Glossy / Parlak
K54199280001VTE0



RAL 2606030

Matt / Mat
K50492180001VTE0
Glossy / Parlak
K50656480001VTE0



RAL 2603035

Matt / Mat
K50597180001VTE0
Glossy / Parlak
K50851480001VTE0



RAL 5002

Matt / Mat
K50490680001VTE0
Glossy / Parlak
K50563280001VTE0
R10B / R10B
K51027680001VTE0

Neutral

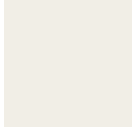

RAL 1009005
Matt / Mat
K52764280001VTE0
Glossy / Parlak
K53464280001VTE0

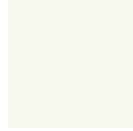

RAL 0809005
Matt / Mat
K50611180001VTE0
Glossy / Parlak
K02821580001VTE0
R10B / R10B
K51162280001VTE0

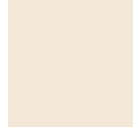

RAL 0809010
Matt / Mat
K50584280001VTE0
Glossy / Parlak
K50847080001VTE0
R10B / R10B
K53413080001VTE0



RAL 0808010
Matt / Mat
K52763180001VTE0

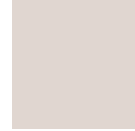

RAL 0958010
Matt / Mat
K50494380001VTE0
Glossy / Parlak
K50715080001VTE0



RAL 0007500
Matt / Mat
K50491080001VTE0
Glossy / Parlak
K53410480001VTE0
R10B / R10B
K50503580001VTE0



RAL 0806005
Matt / Mat
K94695980001VTE0



RAL 0505010
Matt / Mat
K94696080001VTE0



RAL 7047
Matt / Mat
K50489580001VTE0
Glossy / Parlak
K50561080001VTE0
R10B/R10B
K50501380001VTE0



RAL 0008000
Matt / Mat
K53391680001VTE0



RAL 0005500
Matt / Mat
K50493280001VTE0
Glossy / Parlak
K51575380001VTE0
R10B / R10B
K50504680001VTE0



RAL 0004000
Matt / Mat
K52443380001VTE0
Glossy / Parlak
K50908580001VTE0
R10B / R10B
K53540180001VTE0

Mood



RAL 3004
Matt / Mat
K50574680001VTE0
Glossy / Parlak
K50682280001VTE0



RAL 0504040
Matt / Mat
K94696280001VTE0



RAL 0706040
Matt / Mat
K94696380001VTE0



RAL 2904015
Matt / Mat
K94696480001VTE0



RAL 0404005
Matt / Mat
K94696580001VTE0



RAL 0606020
Matt / Mat
K94696680001VTE0



RAL 0206005
Matt / Mat
K94696780001VTE0



RAL 1007010
Matt / Mat
K94696880001VTE0



RAL 2205005
Matt / Mat
K94696980001VTE0

Color

Floor tiles
Yer karoları



Floor tile
Yer karosu



Frost resistance
Dona dayanım



Matt
Mat



Glossy
Parlak



Non-rectified
Rektifiyesiz

* ■ M 10 x 10 cm / 4" x 4"
97 x 97 x 6 mm
EN14411 Blb

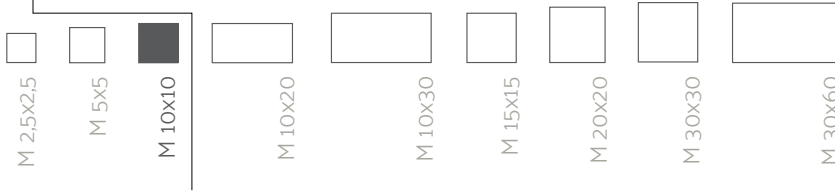

Basic



RAL 9016
Matt / Mat
K50792080001VTEO
Glossy / Parlak
K50382380001VTEO
R9A / R9A
K51840280001VTEO
R10A / R10A
K51878580001VTEO



RAL 9016
R10B / R10B
K94776080001VTEO
C / C
K53458380001VTEO
VitrA Shield
K50792085001VTEO



RAL 0001500
Matt / Mat
K50797580001VTEO
Glossy / Parlak
K50535280001VTEO
R10B/R10B
K51267380001VTEO
C / C
K53460580001VTEO



RAL 1105050
Matt / Mat
K54231680001VTEO
Glossy / Parlak
K54233180001VTEO



RAL 1008080
Matt / Mat
K54230580001VTEO
Glossy / Parlak
K54232080001VTEO



RAL 0808060
Matt / Mat
K53437380001VTEO
RAL 1018
Glossy / Parlak
K50824480001VTEO



RAL 0757070
Matt / Mat
K53433680001VTEO
Glossy / Parlak
K53452480001VTEO



RAL 2003
Matt / Mat
K52997480001VTEO
RAL 2010
Glossy / Parlak
K53451380001VTEO



RAL 0304050
Matt / Mat
K53420080001VTEO
RAL 3000
Glossy / Parlak
K52644180001VTEO

Aqua



RAL 2008020
Matt / Mat
K50205180001VTEO
Glossy / Parlak
K50655380001VTEO



RAL 2006020
Matt / Mat
K54202580001VTEO



RAL 2004030
Matt / Mat
K53445480001VTEO
Glossy / Parlak
K53411580001VTEO



RAL 2307015
Matt / Mat
K94835880001VTEO
Glossy / Parlak
K50534180001VTEO
R10B / R10B
K94776480001VTEO



RAL 2306020
Matt / Mat
K53447680001VTEO



RAL 2404020
Matt / Mat
K54201480001VTEO



RAL 2606030
Matt / Mat
K50206280001VTEO
Glossy / Parlak
K50654280001VTEO
C / C
K54165880001VTEO



RAL 2603035
Matt / Mat
K53465380001VTEO
Glossy / Parlak
K94776380001VTEO
R10B / R10B
K54166080001VTEO
C / C
K54165980001VTEO



RAL 5002
Matt / Mat
K50796480001VTEO
Glossy / Parlak
K50533080001VTEO
R10B / R10B
K53455080001VTEO
C / C
K53015180001VTEO

Neutral

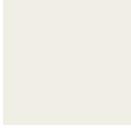

RAL 1009005
Matt / Mat
K52770180001VTE0
Glossy / Parlak
K53453580001VTE0

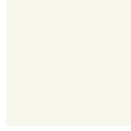

RAL 0809005
Matt / Mat
K50612280001VTE0
Glossy / Parlak
K50647280001VTE0

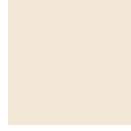

RAL 0809010
Matt / Mat
K50528280001VTE0
Glossy / Parlak
K50648380001VTE0
R10B/R10B
K53456180001VTE0



RAL 0808010
Matt / Mat
K52769080001VTE0

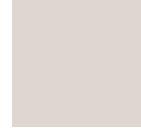

RAL 0958010
Matt / Mat
K54207380001VTE0
Glossy / Parlak
K50956580001VTE0



RAL 0007500
Matt / Mat
K50798680001VTE0
Glossy / Parlak
K51142380001VTE0
R9A / R9A
K51842480001VTE0
R10A / R10A
K51879680001VTE0
R10B / R10B
K94776180001VTE0



RAL 0806005
Matt / Mat
K54208480001VTE0



RAL 0505010
Matt / Mat
K54209580001VTE0

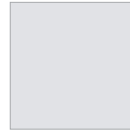

RAL 7047
Matt / Mat
K50793180001VTE0
Glossy / Parlak
K50401180001VTE0
R10B / R10B
K94776280001VTE0
C / C
K53459480001VTE0



RAL 0008000
Matt / Mat
K53419680001VTE0



RAL 0005500
Matt / Mat
K50794280001VTE0
Glossy / Parlak
K50733480001VTE0
R10B/R10B
K50300580001VTE0



RAL 0004000
Matt / Mat
K50790580001VTE0
Glossy / Parlak
K52051380001VTE0
R10B / R10B
K53542380001VTE0

Mood



RAL 3004
Matt / Mat
K50816380001VTE0



RAL 0504040
Matt / Mat
K54165380001VTE0



RAL 0706040
Matt / Mat
K54168680001VTE0



RAL 2904015
Matt / Mat
K54169080001VTE0



RAL 0404005
Matt / Mat
K54170180001VTE0



RAL 0606020
Matt / Mat
K54166480001VTE0



RAL 0206005
Matt / Mat
K54171280001VTE0



RAL 1007010
Matt / Mat
K54172380001VTE0



RAL 2205005
Matt / Mat
K54167580001VTE0

Color

Floor tiles
Yer karoları



Floor tile
Yer karosu



Frost resistance
Dona dayanım



Matt
Mat



Glossy
Parlak



Non-rectified
Rektifiyesiz

M 10 x 20 cm / 4" x 8"
97 x 197 x 6 mm
EN14411 Blb

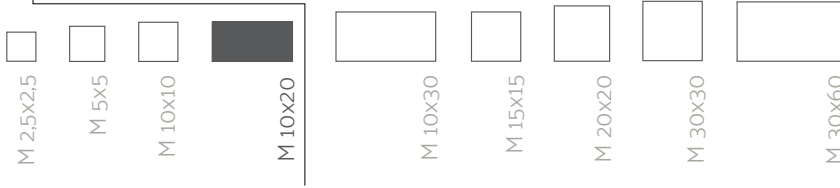

Basic



RAL 9016
Matt / Mat
K50079100001VTE0
Glossy / Parlak
K76635600001VTE0
R10B / R10B
K50086100001VTE0
C / C
K77222300001VTE0



RAL 0001500
Matt / Mat
K50068400001VTE0
Glossy / Parlak
K77635500001VTE0
R10B / R10B
K77221200001VTE0



RAL 1105050
Matt / Mat
K54236400001VTE0



RAL 1008080
Matt / Mat
K54235300001VTE0



RAL 2003
Matt / Mat
K54234200001VTE0



RAL 3000
Glossy / Parlak
K52645200001VTE0

Aqua



RAL 2008020
Matt / Mat
K50280600001VTE0



RAL 2006020
Matt / Mat
K54204000001VTE0

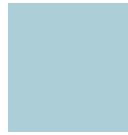

RAL 2307015
Matt / Mat
K50080200001VTE0
Glossy / Parlak
K77013600001VTE0
R10B/R10B
K50081300001VTE0
C / C
K77223400001VTE0



RAL 2404020
Matt / Mat
K54203600001VTE0



RAL 2606030
Matt / Mat
K50281000001VTE0
Glossy / Parlak
K77634400001VTE0
R10B / R10B
K51068600001VTE0



RAL 2603035
Glossy / Parlak
K50283200001VTE0



RAL 5002
Matt / Mat
K50069500001VTE0
Glossy / Parlak
K77636600001VTE0
R10B / R10B
K77220100001VTE0
C / C
K77224500001VTE0

Neutral

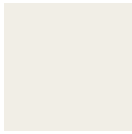

RAL 1009005
Matt / Mat
K89096300001VTE0

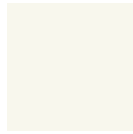

RAL 0809005
Matt / Mat
K86720600001VTE0

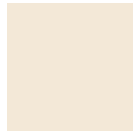

RAL 0809010
Glossy / Parlak
K77908500001VTE0



RAL 0808010
Matt / Mat
K94773600001VTE0



RAL 0958010
Matt / Mat
K54210600001VTE0
Glossy / Parlak
K53802400001VTE0



RAL 0007500
Matt / Mat
K50232000001VTE0
Glossy / Parlak
K89101100001VTE0



RAL 0806005
Matt / Mat
K54211000001VTE0



RAL 0505010
Matt / Mat
K54212100001VTE0



RAL 7047
Matt / Mat
K50237500001VTE0
Glossy / Parlak
K85300200001VTE0
R10B / R10B
K50287600001VTE0
C / C
K89105500001VTE0



RAL 0008000
Matt / Mat
K94773400001VTE0



RAL 0005500
Matt / Mat
K50272500001VTE0
Glossy / Parlak
K89100000001VTE0



RAL 0004000
Matt / Mat
K94773500001VTE0

Color

Floor tiles Yer karoları



Floor tile
Yer karosu



Frost resistance
Dona dayanım



Matt
Mat



Glossy
Parlak



Non-rectified
Rektifiyesiz

■ M 10 x 30 cm / 4" x 12"
97 x 297 x 6 mm
EN14411 Blb

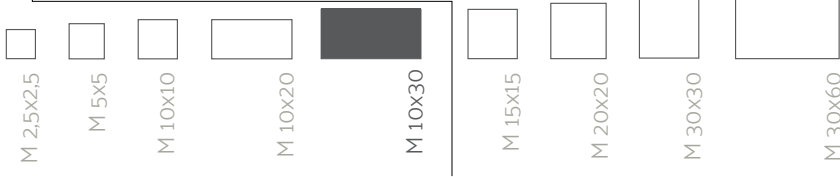

Basic



RAL 9016
Matt / Mat
K78512200001VTE0
K785122C0001VTE0
Glossy / Parlak
K79060500001VTE0
VitrA Shield
K785122S0001VTE0



RAL 0001500
Matt / Mat
K79059400001VTE0
Glossy / Parlak
K79421200001VTE0



RAL 1105050
Glossy / Parlak
K54238600001VTE0



RAL 1008080
Glossy / Parlak
K54237500001VTE0



RAL 0808060
Matt / Mat
K89124300001VTE0



RAL 2010
Glossy / Parlak
K86037200001VTE0



RAL 0304050
Matt / Mat
K89114000001VTE0
RAL 3000
Glossy / Parlak
K87662300001VTE0

Aqua



RAL 2008020
Matt / Mat
K89132400001VTE0



RAL 2307015
Matt / Mat
K80575600001VTE0



RAL 2606030
Matt / Mat
K79432600001VTE0



RAL 2603035
Matt / Mat
K86623000001VTE0
Glossy / Parlak
K89136100001VTE0



RAL 5002
Matt / Mat
K89108100001VTE0
Glossy / Parlak
K87665600001VTE0

Neutral

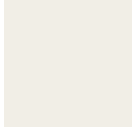

RAL 1009005
Matt / Mat
K86154000001VTE0
Glossy / Parlak
K86155100001VTE0

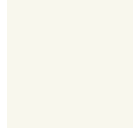

RAL 0809005
Matt / Mat
K80306000001VTE0
Glossy / Parlak
K81268100001VTE0

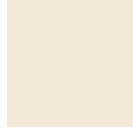

RAL 0809010
Matt / Mat
K83808000001VTE0
Glossy / Parlak
K88626200001VTE0

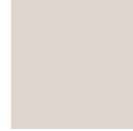

RAL 0958010
Matt / Mat
K54213200001VTE0
Glossy / Parlak
K79301100001VTE0

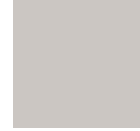

RAL 0007500
Matt / Mat
K79397600001VTE0
Glossy / Parlak
K79425600001VTE0



RAL 0806005
Matt / Mat
K54214300001VTE0
Glossy / Parlak
K54217600001VTE0



RAL 0505010
Matt / Mat
K54215400001VTE0
Glossy / Parlak
K54218000001VTE0



RAL 7047
Matt / Mat
K79422300001VTE0
Glossy / Parlak
K79423400001VTE0



RAL 0008000
Matt / Mat
K89113600001VTE0



RAL 0005500
Matt / Mat
K78591400001VTE0
Glossy / Parlak
K79424500001VTE0



RAL 0004000
Matt / Mat
K79048000001VTE0
Glossy / Parlak
K79426000001VTE0

Mood



RAL 3004
Glossy / Parlak
K79971100001VTE0



RAL 0504040
Glossy / Parlak
K08608300001VTE0



RAL 0706040
Glossy / Parlak
K08611600001VTE0



RAL 2904015
Glossy / Parlak
K08612000001VTE0



RAL 0404005
Glossy / Parlak
K08613100001VTE0



RAL 0606020
Glossy / Parlak
K08609400001VTE0



RAL 0206005
Glossy / Parlak
K08614200001VTE0



RAL 1007010
Glossy / Parlak
K08615300001VTE0



RAL 2205005
Glossy / Parlak
K08610500001VTE0

Color

Floor tiles Yer karoları



Floor tile
Yer karosu



Frost resistance
Dona dayanım



Matt
Mat



Glossy
Parlak



Non-rectified
Rektifiyesiz

M 15 x 15 cm / 6" x 6"
147 x 147 x 6 mm
EN14411 Blb



M 2,5x2,5



M 5x5



M 10x10



M 10x20



M 10x30



M 15x15



M 20x20



M 30x30



M 30x60

Basic



RAL 9016

Matt / Mat
K94772800001VTE0
Glossy / Parlak
K76797200001VTE0
R10B / R10B
K94776500001VTE0



RAL 0001500

Matt / Mat
K947730000001VTE0
Glossy / Parlak
K89167400001VTE0



RAL 1105050

Matt / Mat
K54240100001VTE0



RAL 1008080

Matt / Mat
K54239000001VTE0



RAL 0808060

Matt / Mat
K89163000001VTE0

RAL 1018

Glossy / Parlak
K75703300001VTE0



RAL 2003

Matt / Mat
K84914000001VTE0



RAL 0304050

Matt / Mat
K89159300001VTE0

Aqua

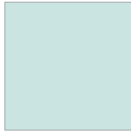

RAL 2008020

Matt / Mat
K89166300001VTE0



RAL 2606030

Matt / Mat
K76434100001VTE0



RAL 2603035

Matt / Mat
K87875600001VTE0

Neutral

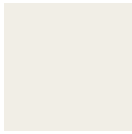

RAL 1009005
Matt / Mat
K85537600001VTE0

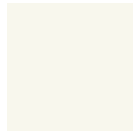

RAL 0809005
Matt / Mat
K87879300001VTE0

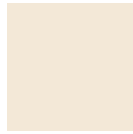

RAL 0809010
Matt / Mat
K78763200001VTE0



RAL 0808010
Matt / Mat
K83941000001VTE0



RAL 0958010
Matt / Mat
K54219100001VTE0



RAL 0007500
Matt / Mat
K50284300001VTE0
R10B / R10B
K94776600001VTE0



RAL 0806005
Matt / Mat
K54220200001VTE0



RAL 0505010
Matt / Mat
K54221300001VTE0



RAL 7047
Matt / Mat
K94780700001VTE0
Glossy / Parlak
K78277400001VTE0
R10B / R10B
K94776700001VTE0



RAL 0008000
Matt / Mat
K89158200001VTE0



RAL 0005500
Matt / Mat
K50285400001VTE0
Glossy / Parlak
K78278500001VTE0



RAL 0004000
Matt / Mat
K80205400001VTE0
Glossy / Parlak
K89168500001VTE0

Color

Floor tiles Yer karoları



Floor tile
Yer karosu



Frost resistance
Dona dayanım



Matt
Mat



Glossy
Parlak



Non-rectified
Rektifiyesiz

* M 20 x 20 cm / 8" x 8"
197 x 197 x 6 mm
EN14411 Blb



M 2,5x2,5



M 5x5



M 10x10



M 10x20



M 10x30



M 15x15



M 20x20



M 30x30



M 30x60

Basic



RAL 9016

Matt / Mat
K78042600001VTE0
K780426C0001VTE0
Glossy / Parlak
K75907100001VTE0
R9A/R9A
K81803400001VTE0
R10B/R10B
K94776800001VTE0
VitrA Shield
K780426S0001VTE0



RAL 0001500

Matt / Mat
K78047400001VTE0
Glossy / Parlak
K79845100001VTE0



RAL 1105050

Matt / Mat
K94364500001VTE0



RAL 1008080

Matt / Mat
K94363400001VTE0



RAL 0808060

Matt / Mat
K89186200001VTE0

RAL 1018

Glossy / Parlak
K76073400001VTE0



RAL 0757070

Matt / Mat
K94379600001VTE0



RAL 2003

Matt / Mat
K94378500001VTE0

RAL 2010

Glossy / Parlak
K89188400001VTE0



RAL 0304050

Matt / Mat
K89183600001VTE0

RAL 3000

Glossy / Parlak
K52647400001VTE0

Aqua



RAL 2008020

Matt / Mat
K50219100001VTE0



RAL 2006020

Matt / Mat
K94366000001VTE0



RAL 2004030

Matt / Mat
K94381100001VTE0



RAL 2307015

Matt / Mat
K94772700001VTE0
Glossy / Parlak
K89197600001VTE0



RAL 2306020

Matt / Mat
K94380000001VTE0



RAL 2404020

Matt / Mat
K94365600001VTE0



RAL 2606030

Matt / Mat
K50220200001VTE0



RAL 2603035

Matt / Mat
K75904500001VTE0
Glossy / Parlak
K89198000001VTE0



RAL 5002

Matt / Mat
K78046300001VTE0
Glossy / Parlak
K76223000001VTE0

Neutral

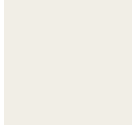

RAL 1009005
Matt / Mat
K85532100001VTE0
Glossy / Parlak
K89196500001VTE0

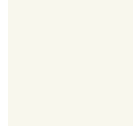

RAL 0809005
Matt / Mat
K76141200001VTE0
Glossy / Parlak
K79808600001VTE0
R10B / R10B
K77961200001VTE0

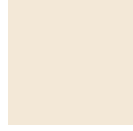

RAL 0809010
Matt / Mat
K80862400001VTE0
Glossy / Parlak
K81494300001VTE0
R10B / R10B
K89203500001VTE0



RAL 0808010
Matt / Mat
K85531000001VTE0

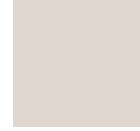

RAL 0958010
Matt / Mat
K94367100001VTE0
Glossy / Parlak
K79809000001VTE0



RAL 0007500
Matt / Mat
K78044100001VTE0
Glossy / Parlak
K81776500001VTE0
R9A / R9A
K81805600001VTE0
R10A / R10A
K81976200001VTE0
R10B / R10B
K94776900001VTE0



RAL 0806005
Matt / Mat
K94368200001VTE0



RAL 0505010
Matt / Mat
K94369300001VTE0



RAL 7047
Matt / Mat
K78043000001VTE0
Glossy / Parlak
K79817100001VTE0
R10B / R10B
K94777000001VTE0



RAL 0008000
Matt / Mat
K89182500001VTE0



RAL 0005500
Matt / Mat
K50209500001VTE0
Glossy / Parlak
K79818200001VTE0



RAL 0004000
Matt / Mat
K78149200001VTE0
Glossy / Parlak
K89189500001VTE0

Mood



RAL 3004
Matt / Mat
K78049500001VTE0



RAL 0504040
Matt / Mat
K94370400001VTE0



RAL 0706040
Matt / Mat
K94373000001VTE0



RAL 2904015
Matt / Mat
K94374100001VTE0



RAL 0404005
Matt / Mat
K94375200001VTE0



RAL 0606020
Matt / Mat
K94371500001VTE0



RAL 0206005
Matt / Mat
K94376300001VTE0



RAL 1007010
Matt / Mat
K94377400001VTE0



RAL 2205005
Matt / Mat
K94372600001VTE0

Please refer to pages 86-87 for complimentary parts.
Uyumlu tamamlayıcı parçalar için sayfa 86-87'e bakınız.

* All matt colors are available in 20x20.
20x20 ebadında tüm mat renkler mevcuttur.

Color

Floor tiles Yer karoları



Floor tile
Yer karosu



Frost resistance
Dona dayanım



Matt
Mat



Glossy
Parlak



Non-rectified
Rektifiyesiz

M 30 x 30 cm / 12" x 12"
297 x 297 x 7 mm
EN14411 Blb



M 2,5x2,5



M 5x5



M 10x10



M 10x20



M 10x30



M 15x15



M 20x20



M 30x30



M 30x60

Basic



RAL 9016

Matt / Mat

K94772900001VTE0

Glossy / Parlak

K78830600001VTE0

R10B / R10B

K94777100001VTE0



RAL 0001500

Matt / Mat

K94773100001VTE0



RAL 3000

Glossy / Parlak

K52648500001VTE0

Aqua



RAL 2307015

Matt / Mat

K94777400001VTE0

R10B / R10B

K89217500001VTE0

Neutral

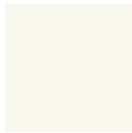

RAL 0809005

Matt / Mat

K77296000001VTE0



RAL 0809010

Matt / Mat

K76899500001VTE0

R10B / R10B

K89216400001VTE0



RAL 0958010

Matt / Mat

K80768100001VTE0



RAL 0007500

Matt / Mat

K94773200001VTE0

R10B / R10B

K94777200001VTE0



RAL 7047

Matt / Mat

K94773300001VTE0

R10B / R10B

K94777300001VTE0



RAL 0008000

Matt / Mat

K89208300001VTE0



RAL 0005500

Matt / Mat

K75444500001VTE0



RAL 0004000

Matt / Mat

K86460500001VTE0

Glazed porcelain tiles
Sırlı porselen karolar



Porcelain
Porselen



Frost resistance
Dona dayanım



Matt
Mat



Non-rectified
Rektifiyesiz

Color options in size order
Ebatlara göre renk dizilimi

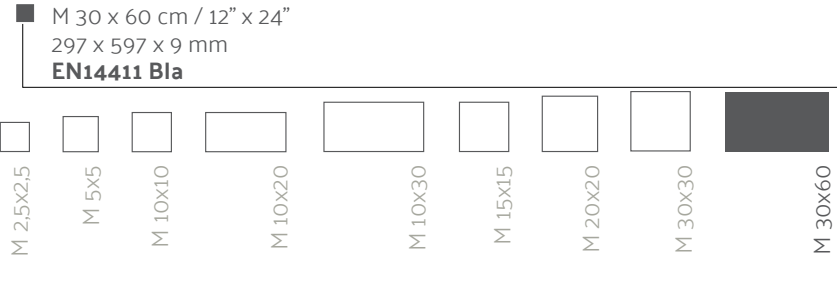

Basic



RAL 9016
Matt / Mat
K89223400001VTE0
R10A / R10A
K94376500001VTE0
VitrA Shield
K892234S0001VTE0



RAL 0001500
Matt / Mat
K89224500001VTE0

Neutral

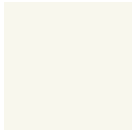

RAL 0809005
Matt / Mat
K94902100001VTE0

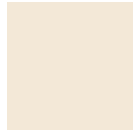

RAL 0809010
Matt / Mat
K89233000001VTE0



RAL 0007500
Matt / Mat
K89231500001VTE0



RAL 7047
Matt / Mat
K78816600001VTE0



RAL 0005500
Matt / Mat
K89228200001VTE0

Color

Wall tiles
Duvar karoları



M 10 x 30 cm / 4" x 12"
98x298x7,5 mm
EN14411 BIII

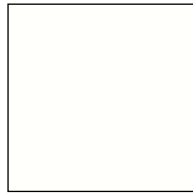
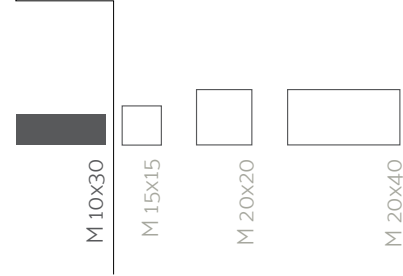

RAL 9016
Matt / Mat
K08607200001VTE0
Glossy / Parlak
K94341900001VTE0



RAL 0001500
Matt / Mat
K94420800001VTE0

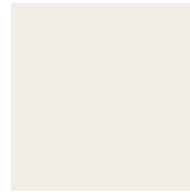

RAL 1009005
Matt / Mat
K94420900001VTE0
Glossy / Parlak
K94421800001VTE0

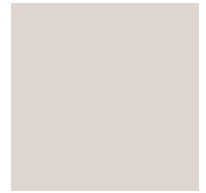

RAL 0958010
Matt / Mat
K94420700001VTE0
Glossy / Parlak
K94421700001VTE0

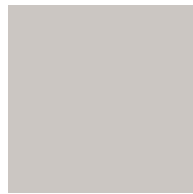

RAL 0007500
Matt / Mat
K94421100001VTE0
Glossy / Parlak
K94422100001VTE0

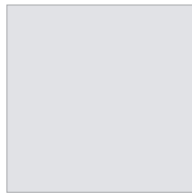

RAL 7047
Matt / Mat
K94426900001VTE0
Glossy / Parlak
K94421900001VTE0

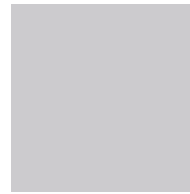

RAL 0008000
Matt / Mat
K94418400001VTE0



RAL 0005500
Matt / Mat
K94421000001VTE0

Color options in size order Ebatlara göre renk dizilimi

■ M 15 x 15 cm / 6" x 6"
148x148x6 mm
EN14411 BIII



M 10x30



M 15x15



M 20x20



M 20x40

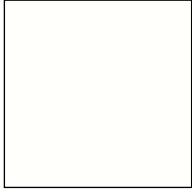

RAL 9016

Matt / Mat

K94777600001VTE0

Glossy / Parlak

K94777500001VTE0

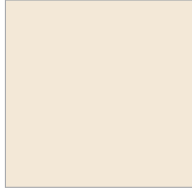

RAL 0809010

Matt / Mat

K78209600001VTE0

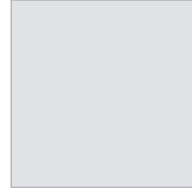

RAL 7047

Matt / Mat

K77314500001VTE0

Color

Wall tiles
Duvar karoları

Wall tile
Duvar karosu

Matt
Mat

Glossy
Parlak

Non-rectified
Rektifiyesiz

■ M 20 x 20 cm / 8" x 8"
198x198x6 mm
EN14411 BIII

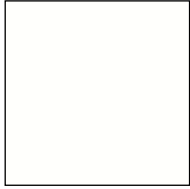
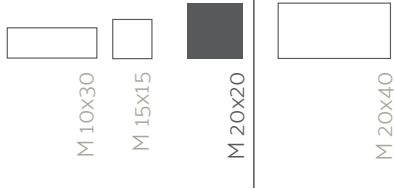

RAL 9016

Matt / Mat
K94777800001VTE0
K948368B0001VTE0
Glossy / Parlak
K9477700001VTE0
K948367B0001VTE0

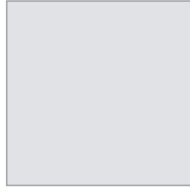

RAL 7047

Matt / Mat
K77574000001VTE0

Color options in size order Ebatlara göre renk dizilimi

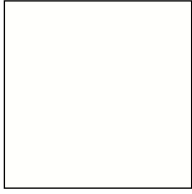
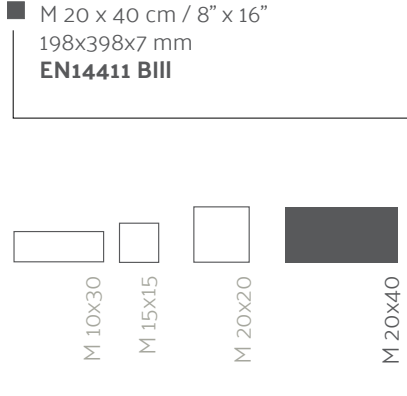

RAL 9016
Matt / Mat
K94407000001VTE0
K944070B0001VTE0
Glossy / Parlak
K94407100001VTE0
K944071B0001VTE0
VitrA Shield
K944070S0001VTE0

Color

Basic



* RAL 9016

M 2.5x2.5 Matt / Mat K02770380001VTEO
M 2.5x2.5 Glossy / Parlak K02771480001VTEO
M 2.5x2.5 R10B K52873680001VTEO
M 5x5 Matt / Mat K50488480001VTEO
M 5x5 Glossy / Parlak K50560680001VTEO
M 5x5 R10B K50500280001VTEO
M 10x10 Vitra Shield K5079208001VTEO
M 10x10 Matt / Mat K50792080001VTEO
M 10x10 Glossy / Parlak K50382380001VTEO
M 10x10 R9A K51840280001VTEO
M 10x10 R10A K51878580001VTEO
M 10x10 R10B K94776080001VTEO
M 10x10 C K53458380001VTEO
M 10x20 Matt / Mat K50079100001VTEO
M 10x20 Glossy / Parlak K76635600001VTEO
M 10x20 R10B K50086100001VTEO
M 10x20 C K77222300001VTEO
M 10x30 Vitra Shield K78512250001VTEO
M 10x30 Matt / Mat K78512200001VTEO
M 10x30 Glossy / Parlak K78512200001VTEO
M 10x30 Glossy / Parlak K79060500001VTEO
M 15x15 Matt / Mat K94772800001VTEO
M 15x15 Glossy / Parlak K76797200001VTEO
M 15x15 R10B K94776500001VTEO
M 20x20 Vitra Shield K78042650001VTEO
M 20x20 Matt / Mat K78042600001VTEO
M 20x20 Matt / Mat K78042600001VTEO
M 20x20 Matt / Mat K94836800001VTEO
M 20x20 Glossy / Parlak K75907100001VTEO
M 20x20 Glossy / Parlak K94836700001VTEO
M 20x20 R9A K81803400001VTEO
M 20x20 R10B K94776800001VTEO
M 30x30 Matt / Mat K94772900001VTEO
M 30x30 Glossy / Parlak K78830600001VTEO
M 30x30 R10B K94777100001VTEO
M 30x60 Vitra Shield K89223400001VTEO
M 30x60 Matt / Mat K89223400001VTEO
M 30x60 R10A K94376500001VTEO
M 10x30D Matt / Mat K08607200001VTEO
M 10x30D Glossy / Parlak K94341900001VTEO
M 15x15D Matt / Mat K94777600001VTEO
M 15x15D Glossy / Parlak K94777500001VTEO
M 20x20D Matt / Mat K9477800001VTEO
M 20x20D Glossy / Parlak K9477700001VTEO
M 20x40D Vitra Shield K9440700001VTEO
M 20x40D Matt / Mat K9440700001VTEO
M 20x40D Matt / Mat K9440700001VTEO
M 20x40D Glossy / Parlak K94407100001VTEO
M 20x40D Glossy / Parlak K94407100001VTEO



* RAL 0001500

M 2.5x2.5 Matt / Mat K02765580001VTEO
M 2.5x2.5 Glossy / Parlak K02766680001VTEO
M 2.5x2.5 R10A K54054480001VTEO
M 2.5x2.5 R10B K53384680001VTEO
M 5x5 Matt / Mat K50498080001VTEO
M 5x5 Glossy / Parlak K50565480001VTEO
M 5x5 R10B K52360480001VTEO
M 10x10 Matt / Mat K50797580001VTEO
M 10x10 Glossy / Parlak K50535280001VTEO
M 10x10 R10B K51267380001VTEO
M 10x10 C K53460580001VTEO
M 10x20 Matt / Mat K50068400001VTEO
M 10x20 Glossy / Parlak K77635500001VTEO
M 10x20 R10B K77221200001VTEO
M 10x30 Matt / Mat K79059400001VTEO
M 10x30 Glossy / Parlak K79421200001VTEO
M 15x15 Matt / Mat K94773000001VTEO
M 15x15 Glossy / Parlak K89167400001VTEO
M 20x20 Matt / Mat K78047400001VTEO
M 20x20 Glossy / Parlak K79845100001VTEO
M 30x30 Matt / Mat K94773100001VTEO
M 10x30D Matt / Mat K94420800001VTEO
M 30x60 Matt / Mat K89224500001VTEO



RAL 1105050

M 2.5x2.5 Matt / Mat K54223580001VTEO
M 2.5x2.5 Glossy / Parlak K54225080001VTEO
M 5x5 Matt / Mat K54227280001VTEO
M 5x5 Glossy / Parlak K54229480001VTEO
M 10x10 Matt / Mat K54231680001VTEO
M 10x10 Glossy / Parlak K54233180001VTEO
M 10x20 Matt / Mat K54236400001VTEO
M 10x30 Glossy / Parlak K54238600001VTEO
M 15x15 Matt / Mat K54240100001VTEO
M 20x20 Matt / Mat K94364500001VTEO



RAL 1008080

M 2.5x2.5 Matt / Mat K54222480001VTEO
M 2.5x2.5 Glossy / Parlak K54224680001VTEO
M 5x5 Matt / Mat K54226180001VTEO
M 5x5 Glossy / Parlak K54228380001VTEO
M 10x10 Matt / Mat K54230580001VTEO
M 10x10 Glossy / Parlak K54232080001VTEO
M 10x20 Matt / Mat K54235300001VTEO
M 10x30 Glossy / Parlak K54237500001VTEO
M 15x15 Matt / Mat K54239000001VTEO
M 20x20 Matt / Mat K94363400001VTEO



RAL 0808060

M 2.5x2.5 Matt / Mat K53371080001VTEO
M 2.5x2.5 R10A/R10A K54056680001VTEO
M 5x5 Matt / Mat K53400180001VTEO
M 10x10 Matt / Mat K53437380001VTEO
M 10x30 Matt / Mat K89124300001VTEO
M 15x15 Matt / Mat K89163000001VTEO
M 20x20 Matt / Mat K89186200001VTEO



RAL 1018

M 2.5x2.5 Glossy / Parlak K02761180001VTEO
M 5x5 Glossy / Parlak K50495480001VTEO
M 10x10 Glossy / Parlak K50824480001VTEO
M 15x15 Glossy / Parlak K75703300001VTEO
M 20x20 Glossy / Parlak K76073400001VTEO

Size options in color order Renklere göre ebat dizilimi



RAL 0757070

M 25x25 Matt / Mat K53524680001VTEO
M 5x5 Matt / Mat K94697080001VTEO
M 10x10 Matt / Mat K53433680001VTEO
M 10x10 Glossy / Parlak K53452480001VTEO
M 20x20 Matt / Mat K94379600001VTEO



RAL 2003

M 25x25 Matt / Mat K52046580001VTEO
M 5x5 Matt / Mat K94695680001VTEO
M 10x10 Matt / Mat K52997480001VTEO
M 10x20 Matt / Mat K54234200001VTEO
M 15x15 Matt / Mat K84914000001VTEO
M 20x20 Matt / Mat K94378500001VTEO



RAL 2010

M 25x25 Glossy / Parlak K52945180001VTEO
M 5x5 Glossy / Parlak K52946280001VTEO
M 10x10 Glossy / Parlak K53451380001VTEO
M 10x30 Glossy / Parlak K86037200001VTEO
M 20x20 Glossy / Parlak K89188400001VTEO



RAL 0304050

M 25x25 Matt / Mat K52679180001VTEO
M 5x5 Matt / Mat K52681380001VTEO
M 10x10 Matt / Mat K53420080001VTEO
M 10x30 Matt / Mat K89114000001VTEO
M 15x15 Matt / Mat K89159300001VTEO
M 20x20 Matt / Mat K89183600001VTEO



RAL 3000

M 25x25 Glossy / Parlak K52642680001VTEO
M 5x5 Glossy / Parlak K52643080001VTEO
M 10x10 Glossy / Parlak K52644180001VTEO
M 10x20 Glossy / Parlak K52645200001VTEO
M 10x30 Glossy / Parlak K87662300001VTEO
M 20x20 Glossy / Parlak K52647400001VTEO
M 30x30 Glossy / Parlak K52648500001VTEO

* RAL 9016, RAL 0001500, RAL 0809005, RAL 0007500, RAL 7047, RAL 0005500 matt colors have all sizes from M2.5x2.5cm to M30x60cm.

RAL 9016, RAL 0001500, RAL 0809005, RAL 0007500, RAL 7047, RAL 0005500 mat renklerinde M2.5x2.5 cm'den M30x60cm'ye kadar tüm ebatlar mevcuttur.

Color

Aqua



RAL 2008020

M 2.5x2.5 Matt / Mat K02788080001VTEO
M 2.5x2.5 Glossy / Parlak K02787680001VTEO
M 5x5 Matt / Mat K50594580001VTEO
M 5x5 Glossy / Parlak K02829680001VTEO
M 10x10 Matt / Mat K50205180001VTEO
M 10x10 Glossy / Parlak K50655380001VTEO
M 10x20 Matt / Mat K50280600001VTEO
M 10x30 Matt / Mat K89132400001VTEO
M 15x15 Matt / Mat K89166300001VTEO
M 20x20 Matt / Mat K50219100001VTEO



RAL 2006020

M 2.5x2.5 Matt / Mat K54194480001VTEO
M 2.5x2.5 Glossy / Parlak K54196680001VTEO
M 5x5 Matt / Mat K54198180001VTEO
M 5x5 Glossy / Parlak K54200380001VTEO
M 10x10 Matt / Mat K54202580001VTEO
M 10x20 Matt / Mat K54204000001VTEO
M 20x20 Matt / Mat K94366000001VTEO



RAL 2004030

M 2.5x2.5 Matt / Mat K53527280001VTEO
M 2.5x2.5 Glossy / Parlak K53727680001VTEO
M 5x5 Matt / Mat K94695780001VTEO
M 10x10 Matt / Mat K53445480001VTEO
M 10x10 Glossy / Parlak K53411580001VTEO
M 20x20 Matt / Mat K94381100001VTEO



RAL 2307015

M 2.5x2.5 Matt / Mat K02789180001VTEO
M 2.5x2.5 Glossy / Parlak K02790280001VTEO
M 2.5x2.5 R10B K52958080001VTEO
M 5x5 Matt / Mat K50497680001VTEO
M 5x5 Glossy / Parlak K50564380001VTEO
M 5x5 R10B K50502480001VTEO
M 10x10 Matt / Mat K94835880001VTEO
M 10x10 Glossy / Parlak K50534180001VTEO
M 10x10 R10B K94776480001VTEO
M 10x20 Matt / Mat K50080200001VTEO
M 10x20 Glossy / Parlak K77013600001VTEO
M 10x20 R10B K50081300001VTEO
M 10x20 C K77223400001VTEO
M 10x30 Matt / Mat K80575600001VTEO
M 20x20 Matt / Mat K94772700001VTEO
M 20x20 Glossy / Parlak K89197600001VTEO
M 30x30 Matt / Mat K94777400001VTEO
M 30x30 R10B K89217500001VTEO



RAL 2306020

M 2.5x2.5 Matt / Mat K53530580001VTEO
M 5x5 Matt / Mat K94695880001VTEO
M 10x10 Matt / Mat K53447680001VTEO
M 20x20 Matt / Mat K94380000001VTEO



RAL 2404020

M 2.5x2.5 Matt / Mat K54193380001VTEO
M 2.5x2.5 Glossy / Parlak K54195580001VTEO
M 5x5 Matt / Mat K54197080001VTEO
M 5x5 Glossy / Parlak K54199280001VTEO
M 10x10 Matt / Mat K54201480001VTEO
M 10x20 Matt / Mat K54203600001VTEO
M 20x20 Matt / Mat K94365600001VTEO

Size options in color order Renklere göre ebat dizilimi

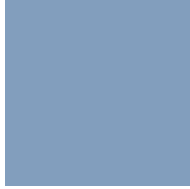

RAL 2606030

M 2.5x2.5 Matt / Mat K02793580001VTEO
M 2.5x2.5 Glossy / Parlak K02792480001VTEO
M 5x5 Matt / Mat K50492180001VTEO
M 5x5 Glossy / Parlak K50656480001VTEO
M 10x10 Matt / Mat K50206280001VTEO
M 10x10 Glossy / Parlak K50654280001VTEO
M 10x10 C K54165880001VTEO
M 10x20 Matt / Mat K50281000001VTEO
M 10x20 Glossy / Parlak K77634400001VTEO
M 10x20 R10B K51068600001VTEO
M 10x30 Matt / Mat K79432600001VTEO
M 15x15 Matt / Mat K76434100001VTEO
M 20x20 Matt / Mat K50220200001VTEO



RAL 2603035

M 2.5x2.5 Matt / Mat K51714280001VTEO
M 2.5x2.5 Glossy / Parlak K02791380001VTEO
M 5x5 Matt / Mat K50597180001VTEO
M 5x5 Glossy / Parlak K50851480001VTEO
M 10x10 C K54165980001VTEO
M 10x10 Matt / Mat K53465380001VTEO
M 10x10 Glossy / Parlak K94776380001VTEO
M 10x10 R10B/R10B K54166080001VTEO
M 10x20 Glossy / Parlak K50283200001VTEO
M 10x30 Matt / Mat K86623000001VTEO
M 10x30 Glossy / Parlak K89136100001VTEO
M 15x15 Matt / Mat K87875600001VTEO
M 20x20 Matt / Mat K75904500001VTEO
M 20x20 Glossy / Parlak K8919800001VTEO



RAL 5002

M 2.5x2.5 Glossy / Parlak K02763380001VTEO
M 2.5x2.5 R10B K53058280001VTEO
M 2.5x2.5 Matt / Mat K02764480001VTEO
M 5x5 R10B K51027680001VTEO
M 5x5 Glossy / Parlak K50563280001VTEO
M 5x5 Matt / Mat K50490680001VTEO
M 10x10 Glossy / Parlak K50533080001VTEO
M 10x10 C K53015180001VTEO
M 10x10 Matt / Mat K50796480001VTEO
M 10x10 R10B K53455080001VTEO
M 10x20 Glossy / Parlak K77636600001VTEO
M 10x20 C K77224500001VTEO
M 10x20 Matt / Mat K50069500001VTEO
M 10x20 R10B K77220100001VTEO
M 10x30 Glossy / Parlak K87665600001VTEO
M 10x30 Matt / Mat K89108100001VTEO
M 20x20 Glossy / Parlak K76223000001VTEO
M 20x20 Matt / Mat K78046300001VTEO

Color

Neutral

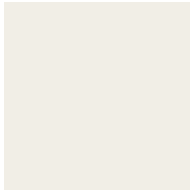

RAL 1009005

M 2.5x2.5 Matt / Mat K52758380001VTEO
M 2.5x2.5 Glossy / Parlak K53382480001VTEO
M 5x5 Matt / Mat K52764280001VTEO
M 5x5 Glossy / Parlak K53464280001VTEO
M 10x10 Matt / Mat K52770180001VTEO
M 10x10 Glossy / Parlak K53453580001VTEO
M 10x20 Matt / Mat K53453580001VTEO
M 10x30 Matt / Mat K86154000001VTEO
M 10x30 Glossy / Parlak K86155100001VTEO
M 15x15 Matt / Mat K85537600001VTEO
M 20x20 Matt / Mat K85532100001VTEO
M 20x20 Glossy / Parlak K89196500001VTEO
M 10x30D Matt / Mat K94420900001VTEO
M 10x30D Glossy / Parlak K94421800001VTEO

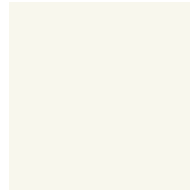

*** RAL 0809005**

M 2.5x2.5 Matt / Mat K02775180001VTEO
M 2.5x2.5 Glossy / Parlak K02776280001VTEO
M 5x5 Matt / Mat K5061180001VTEO
M 5x5 Glossy / Parlak K02821580001VTEO
M 5x5 R10B K51162280001VTEO
M 10x10 Matt / Mat K50612280001VTEO
M 10x10 Glossy / Parlak K50647280001VTEO
M 10x20 Matt / Mat K86720600001VTEO
M 10x30 Matt / Mat K80306000001VTEO
M 10x30 Glossy / Parlak K81268100001VTEO
M 15x15 Matt / Mat K87879300001VTEO
M 20x20 Matt / Mat K76141200001VTEO
M 20x20 Glossy / Parlak K79808600001VTEO
M 20x20 R10B K77961200001VTEO
M 30x30 Matt / Mat K77296000001VTEO
M 30x60 Matt / Mat K94902100001VTEO

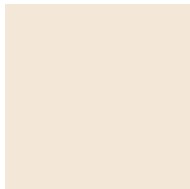

RAL 0809010

M 5x5 Matt / Mat K50584280001VTEO
M 5x5 Glossy / Parlak K50584280001VTEO
M 5x5 R10B K53413080001VTEO
M 10x10 Matt / Mat K50528280001VTEO
M 10x10 Glossy / Parlak K50648380001VTEO
M 10x10 R10B K53456180001VTEO
M 10x20 Glossy / Parlak K77908500001VTEO
M 10x30 Matt / Mat K83808000001VTEO
M 10x30 Glossy / Parlak K88626200001VTEO
M 15x15 Matt / Mat K78209600001VTEO
M 20x20 Matt / Mat K80862400001VTEO
M 20x20 Glossy / Parlak K81494300001VTEO
M 20x20 R10B K89203500001VTEO
M 30x30 Matt / Mat K76899500001VTEO
M 30x30 R10B K89216400001VTEO
M 30x60 Matt / Mat K89233000001VTEO

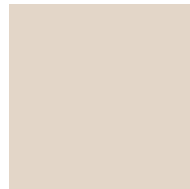

RAL 0808010

M 2.5x2.5 Matt / Mat K52757280001VTEO
M 5x5 Matt / Mat K52763180001VTEO
M 10x10 Matt / Mat K52769080001VTEO
M 10x20 Matt / Mat K94773600001VTEO
M 15x15 Matt / Mat K83941000001VTEO
M 20x20 Matt / Mat K85531000001VTEO

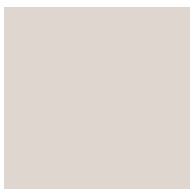

RAL 0958010

M 2.5x2.5 Matt / Mat K02779580001VTEO
M 2.5x2.5 Glossy / Parlak K02780680001VTEO
M 5x5 Matt / Mat K50494380001VTEO
M 5x5 Glossy / Parlak K50715080001VTEO
M 10x10 Matt / Mat K54207380001VTEO
M 10x10 Glossy / Parlak K50956580001VTEO
M 10x20 Matt / Mat K54210600001VTEO
M 10x20 Glossy / Parlak K53802400001VTEO
M 10x30 Matt / Mat K54213200001VTEO
M 10x30 Glossy / Parlak K79301100001VTEO
M 15x15 Matt / Mat K54219100001VTEO
M 20x20 Matt / Mat K94367100001VTEO
M 20x20 Glossy / Parlak K79809000001VTEO
M 30x30 Matt / Mat K80768100001VTEO
M 10x30D Matt / Mat K94420700001VTEO
M 10x30D Glossy / Parlak K94421700001VTEO

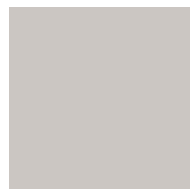

*** RAL 0007500**

M 2.5x2.5 Matt / Mat K02767080001VTEO
M 2.5x2.5 Glossy / Parlak K02975580001VTEO
M 2.5x2.5 R10A/R10A K54053380001VTEO
M 2.5x2.5 R10B K53541280001VTEO
M 5x5 Matt / Mat K50491080001VTEO
M 5x5 Glossy / Parlak K53410480001VTEO
M 5x5 R10B K50503580001VTEO
M 10x10 Matt / Mat K50798680001VTEO
M 10x10 Glossy / Parlak K51142380001VTEO
M 10x10 R9A K51842480001VTEO
M 10x10 R10A K51879680001VTEO
M 10x10 R10B K94776180001VTEO
M 10x20 Matt / Mat K50232000001VTEO
M 10x20 Glossy / Parlak K89101100001VTEO
M 10x30 Matt / Mat K79397600001VTEO
M 10x30 Glossy / Parlak K79425600001VTEO
M 15x15 Matt / Mat K50284300001VTEO
M 15x15 R10B K94776600001VTEO
M 20x20 Matt / Mat K78044100001VTEO
M 20x20 Glossy / Parlak K81776500001VTEO
M 20x20 R9A K81805600001VTEO
M 20x20 R10A K81976200001VTEO
M 20x20 R10B K94776900001VTEO
M 30x30 Matt / Mat K94773200001VTEO
M 30x30 R10B K9477200001VTEO
M 30x60 Matt / Mat K89231500001VTEO
M 10x30D Matt / Mat K94421100001VTEO
M 10x30D Glossy / Parlak K94422100001VTEO

Size options in color order Renklere göre ebat dizilimi

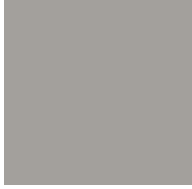

RAL 0806005

M 5x5 Matt / Mat K94695980001VTEO
M 10x10 Matt / Mat K54208480001VTEO
M 10x20 Matt / Mat K54211000001VTEO
M 10x30 Matt / Mat K54214300001VTEO
M 10x30 Glossy / Parlak K54217600001VTEO
M 15x15 Matt / Mat K54220200001VTEO
M 20x20 Matt / Mat K94368200001VTEO

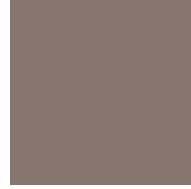

RAL 0505010

M 5x5 Matt / Mat K94696080001VTEO
M 10x10 Matt / Mat K54209580001VTEO
M 10x20 Matt / Mat K54212100001VTEO
M 10x30 Matt / Mat K54215400001VTEO
M 10x30 Glossy / Parlak K54218000001VTEO
M 15x15 Matt / Mat K54221300001VTEO
M 20x20 Matt / Mat K94369300001VTEO

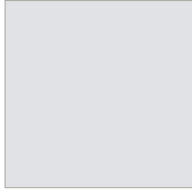

*** RAL 7047**

M 2.5x2.5 Matt / Mat K02768180001VTEO
M 2.5x2.5 Glossy / Parlak K02769280001VTEO
M 2.5x2.5 R10B K53217080001VTEO
M 5x5 Matt / Mat K50489580001VTEO
M 5x5 Glossy / Parlak K50561080001VTEO
M 5x5 R10B K50501380001VTEO
M 10x10 Matt / Mat K50793180001VTEO
M 10x10 Glossy / Parlak K50401180001VTEO
M 10x10 R10B K94776280001VTEO
M 10x10 C K53459480001VTEO
M 10x20 Matt / Mat K50237500001VTEO
M 10x20 Glossy / Parlak K85300200001VTEO
M 10x20 R10B K50287600001VTEO
M 10x20 C K89105500001VTEO
M 10x30 Matt / Mat K79422300001VTEO
M 10x30 Glossy / Parlak K79423400001VTEO
M 15x15 Matt / Mat K79422300001VTEO
M 15x15 Glossy / Parlak K78277400001VTEO
M 15x15 R10B K94776700001VTEO
M 20x20 Matt / Mat K78043000001VTEO
M 20x20 Glossy / Parlak K79817100001VTEO
M 20x20 R10B K94777300001VTEO
M 30x30 Matt / Mat K94773300001VTEO
M 30x30 R10B K94777300001VTEO
M 30x60 Matt / Mat K78816600001VTEO
M 10x30D Matt / Mat K94426900001VTEO
M 10x30D Glossy / Parlak K94421900001VTEO
M 15x15D Matt / Mat K77314500001VTEO
M 20x20D Matt / Mat K77574000001VTEO

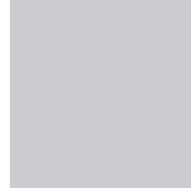

RAL 0008000

M 2.5x2.5 Matt / Mat K53361480001VTEO
M 5x5 Matt / Mat K53391680001VTEO
M 10x10 Matt / Mat K53419680001VTEO
M 10x20 Matt / Mat K94773400001VTEO
M 10x30 Matt / Mat K89113600001VTEO
M 15x15 Matt / Mat K89158200001VTEO
M 20x20 Matt / Mat K89182500001VTEO
M 30x30 Matt / Mat K89208300001VTEO
M 10x30D Matt / Mat K94418400001VTEO

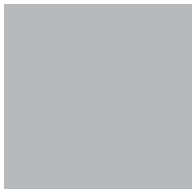

*** RAL 0005500**

M 2.5x2.5 Matt / Mat K02900080001VTEO
M 2.5x2.5 Glossy / Parlak K02901180001VTEO
M 5x5 Matt / Mat K50493280001VTEO
M 5x5 Glossy / Parlak K51575380001VTEO
M 5x5 R10B K50504680001VTEO
M 10x10 Matt / Mat K50794280001VTEO
M 10x10 Glossy / Parlak K50733480001VTEO
M 10x10 R10B K50300580001VTEO
M 10x20 Matt / Mat K50272500001VTEO
M 10x20 Glossy / Parlak K89100000001VTEO
M 10x30 Matt / Mat K78591400001VTEO
M 10x30 Glossy / Parlak K79424500001VTEO
M 15x15 Matt / Mat K50285400001VTEO
M 15x15 Glossy / Parlak K78278500001VTEO
M 20x20 Matt / Mat K50209500001VTEO
M 20x20 Glossy / Parlak K79818200001VTEO
M 30x30 Matt / Mat K75444500001VTEO
M 30x60 Matt / Mat K89228200001VTEO
M 10x30D Matt / Mat K94421000001VTEO



RAL 0004000

M 2.5x2.5 Matt / Mat K51548480001VTEO
M 2.5x2.5 Glossy / Parlak K52278680001VTEO
M 5x5 Matt / Mat K52443380001VTEO
M 5x5 Glossy / Parlak K50908580001VTEO
M 5x5 R10B K53540180001VTEO
M 10x10 Matt / Mat K50790580001VTEO
M 10x10 Glossy / Parlak K52051380001VTEO
M 10x10 R10B K53542380001VTEO
M 10x20 Matt / Mat K94773500001VTEO
M 10x30 Matt / Mat K79048000001VTEO
M 10x30 Glossy / Parlak K79426000001VTEO
M 15x15 Glossy / Parlak K89168500001VTEO
M 15x15 Matt / Mat K80205400001VTEO
M 20x20 Matt / Mat K78149200001VTEO
M 20x20 Glossy / Parlak K89189500001VTEO
M 30x30 Matt / Mat K86460500001VTEO

* RAL 9016, RAL 0001500, RAL 0809005, RAL 0007500, RAL 7047, RAL 0005500 matt colors have all sizes from M2.5x2.5cm to M30x60cm.

RAL 9016, RAL 0001500, RAL 0809005, RAL 0007500, RAL 7047, RAL 0005500 mat renklerinde M2.5x2.5 cm'den M30x60cm'ye kadar tüm ebatlar mevcuttur.

Color

Mood



RAL 3004

M 2.5x2.5 Matt / Mat K02950180001VTE0
M 5x5 Matt / Mat K50574680001VTE0
M 5x5 Glossy / Parlak K50682280001VTE0
M 10x10 Matt / Mat K50816380001VTE0
M 10x30 Glossy / Parlak K79971100001VTE0
M 20x20 Matt / Mat K78049500001VTE0



RAL 0504040

M 5x5 Matt / Mat K94696280001VTE0
M 10x10 Matt / Mat K54165380001VTE0
M 10x30 Glossy / Parlak K08608300001VTE0
M 20x20 Matt / Mat K94370400001VTE0



RAL 0706040

M 5x5 Matt / Mat K94696380001VTE0
M 10x10 Matt / Mat K54168680001VTE0
M 10x30 Glossy / Parlak K08611600001VTE0
M 20x20 Matt / Mat K94373000001VTE0



RAL 2904015

M 5x5 Matt / Mat K94696480001VTE0
M 10x10 Matt / Mat K54169080001VTE0
M 10x30 Glossy / Parlak K08612000001VTE0
M 20x20 Matt / Mat K94374100001VTE0



RAL 0404005

M 5x5 Matt / Mat K94696580001VTE0
M 10x10 Matt / Mat K54170180001VTE0
M 10x30 Glossy / Parlak K08613100001VTE0
M 20x20 Matt / Mat K94375200001VTE0



RAL 0606020

M 5x5 Matt / Mat K94696680001VTE0
M 10x10 Matt / Mat K54166480001VTE0
M 10x30 Glossy / Parlak K08609400001VTE0
M 20x20 Matt / Mat K94371500001VTE0

Size options in color order Renklere göre ebat dizilimi

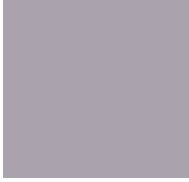

RAL 0206005

M 5x5 Matt / Mat K94696780001VTEO
M 10x10 Matt / Mat K54171280001VTEO
M 10x30 Glossy / Parlak K08614200001VTEO
M 20x20 Matt / Mat K94376300001VTEO

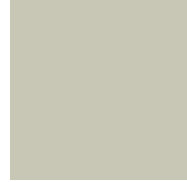

RAL 1007010

M 5x5 Matt / Mat K94696880001VTEO
M 10x10 Matt / Mat K54172380001VTEO
M 10x30 Glossy / Parlak K08615300001VTEO
M 20x20 Matt / Mat K94377400001VTEO



RAL 2205005

M 5x5 Matt / Mat K94696980001VTEO
M 10x10 Matt / Mat K54167580001VTEO
M 10x30 Glossy / Parlak K08610500001VTEO
M 20x20 Matt / Mat K94372600001VTEO

Color

Mix



K50816380001VTEO 10x10 Mood RAL 3004
K53420080001VTEO 10x10 Basic RAL 0304050
K54166480001VTEO 10x10 Mood RAL 0606020
K54168680001VTEO 10x10 Mood RAL 0706040
K52770180001VTEO 10x10 Neutral RAL 1009005

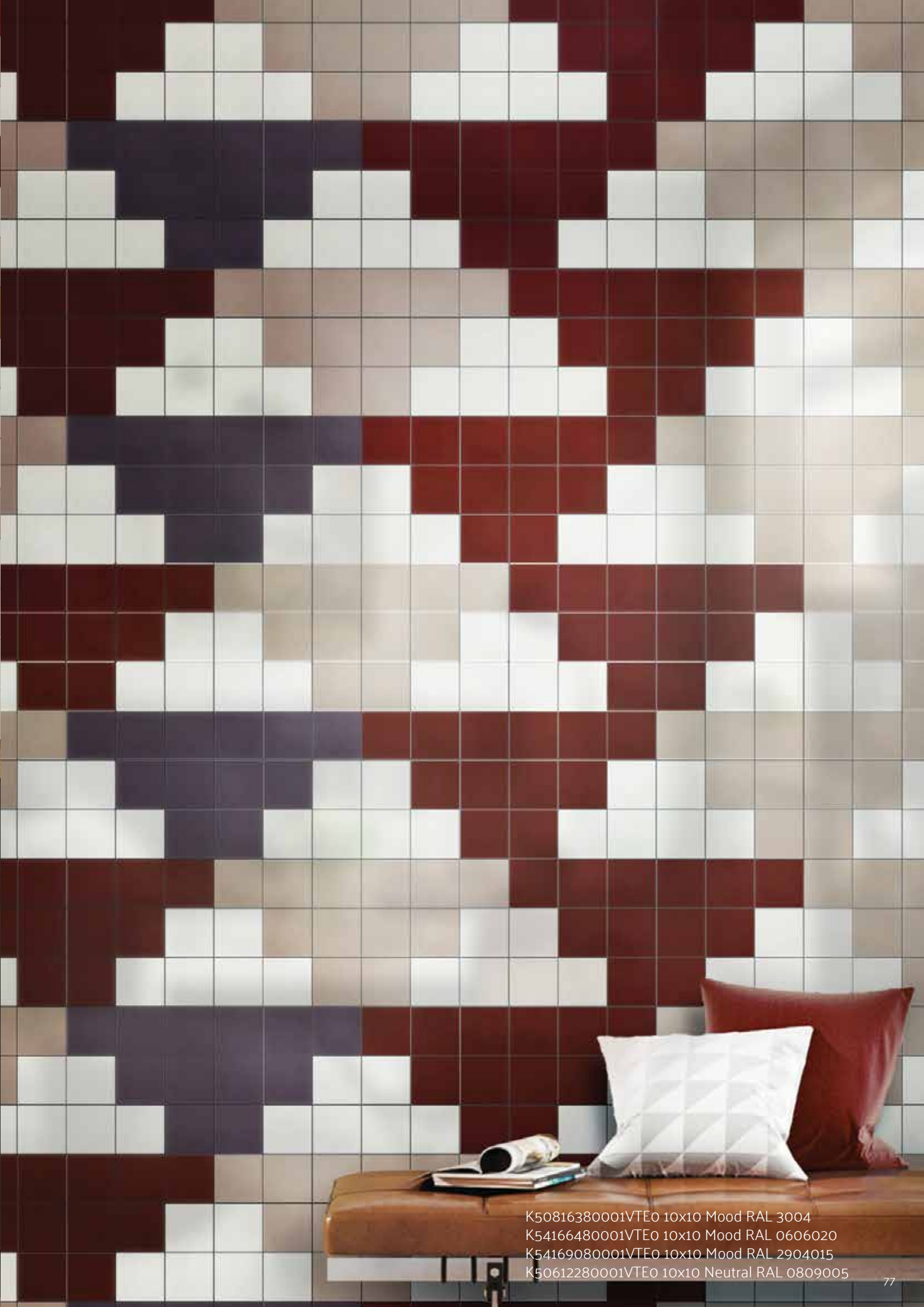

K50816380001VTE0 10x10 Mood RAL 3004
K54166480001VTE0 10x10 Mood RAL 0606020
K54169080001VTE0 10x10 Mood RAL 2904015
K50612280001VTE0 10x10 Neutral RAL 0809005

Color products provides design freedom to you with custom mix mosaic and panel creation. While creating your own visuals and boards, VitrA also offers you design support on how Color products can be used.

Color ürünleri istediğiniz tasarımda mix mozaik ve pano yapma imkânı sağlarken size sadece kendi renklerinizi mekânlarla buluşturmak kalıyor.

VitrA, kendi görsel ve panolarınızı oluştururken size Color ürünlerini ne şekilde kullanabileceğinizle ilgili tasarım desteği de veriyor.



Mix mosaics and board services Mix mozaik ve pano servisi

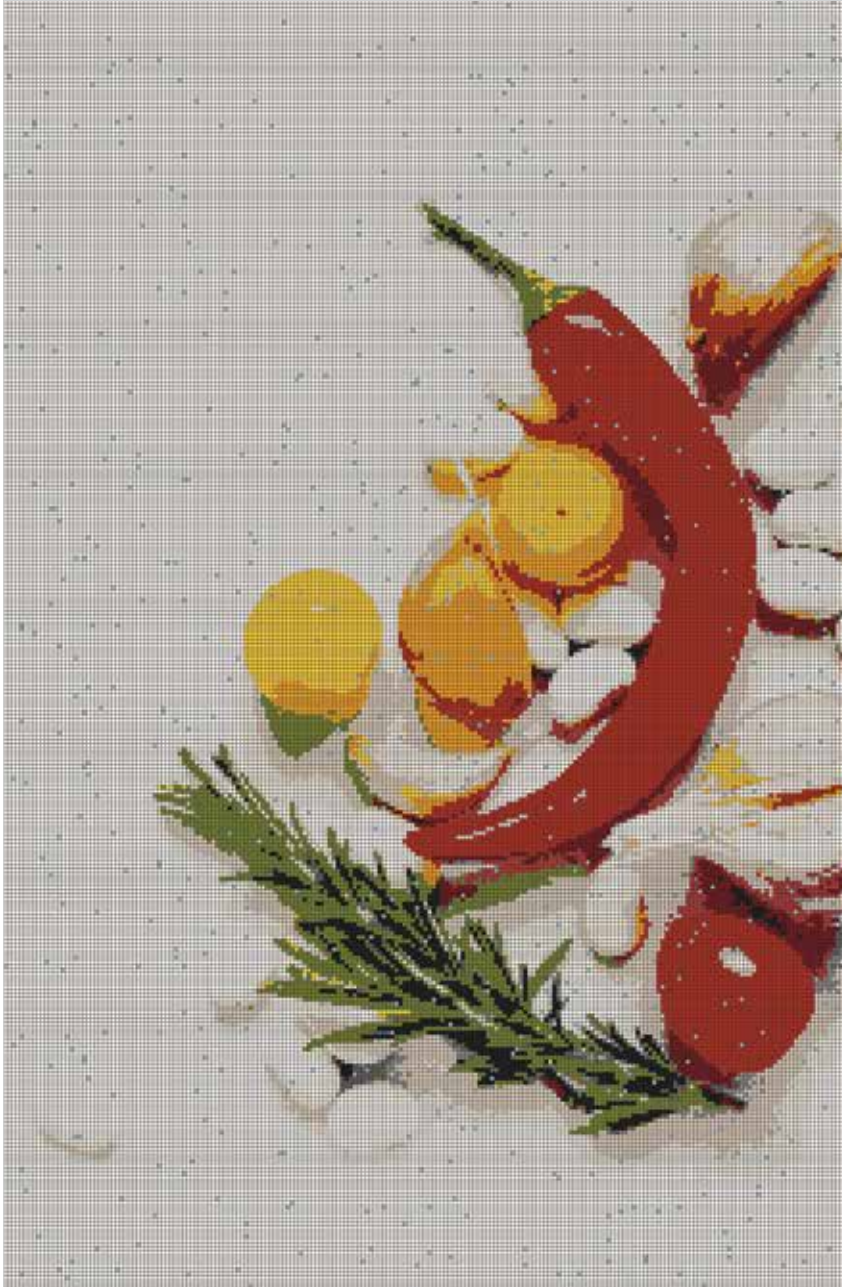

RAL 0001500
Matt / Mat

RAL 0004000
Matt / Mat

RAL 0005500
Matt / Mat

RAL 0007500
Matt / Mat

RAL 0304050
Matt / Mat

RAL 0808010
Matt / Mat

RAL 0809005
Matt / Mat

RAL 1009005
Matt / Mat

RAL 1018
Glossy / Parlak

RAL 7047
Matt / Mat

RAL 3000
Glossy / Parlak

RAL 3004
Matt / Mat

RAL 9016
Matt / Mat

RAL 0008000
Matt / Mat

RAL 0757070
Matt / Mat

RAL 1105050
Matt / Mat

RAL 2307015
Matt / Mat

Color

Mix

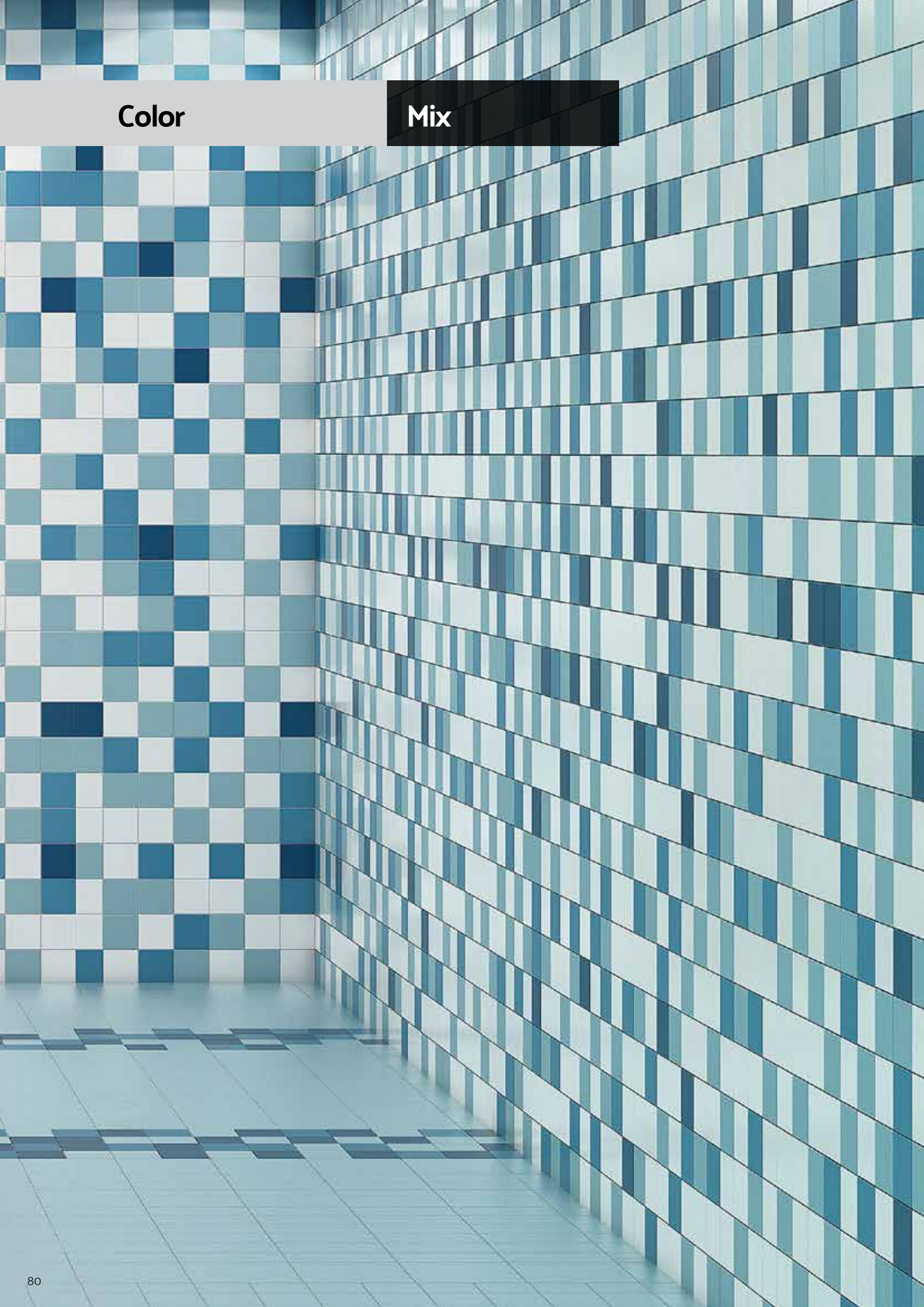

Readily available mix options
Hazır mix mozaik seçenekleri

Mix

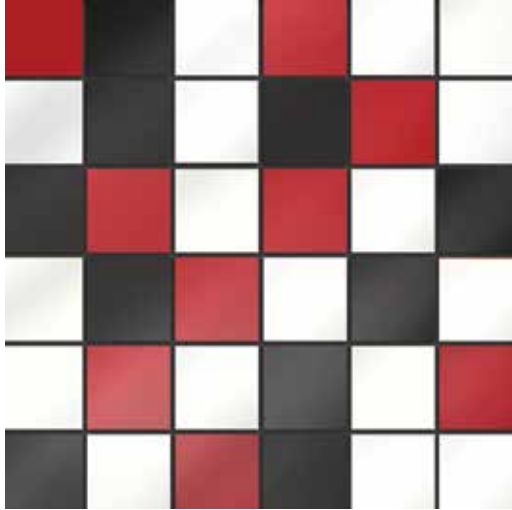

Basic mix

M 5x5
Glossy / Parlak
K94641580001vte0

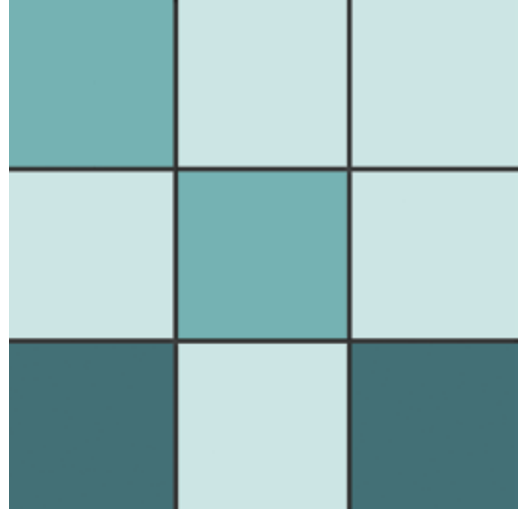

Aqua mix

M 10x10
Matt / Mat
K94641680001vte0

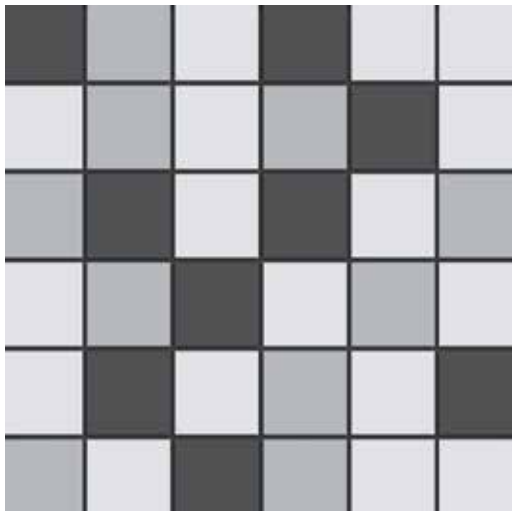

Neutral mix

M 5x5
Matt / Mat
K94641780001vte0

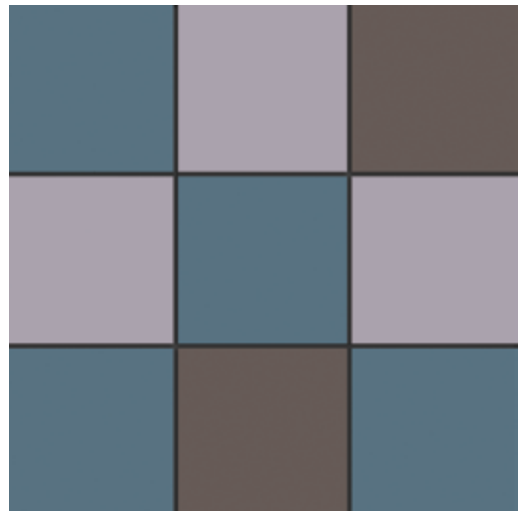

Mood mix

M 10x10
Matt / Mat
K94641880001vte0

Color

Light to dark / Açıktan koyuya



RAL 9016
White
Beyaz

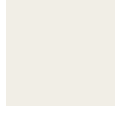

RAL 1009005
Ultra white
Ultra beyaz

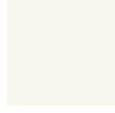

RAL 0809005
Cream
Krem

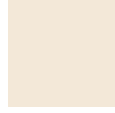

RAL 0809010
Light sand
Açık kum beji



RAL 7047
Light grey
Açık gri



RAL 2008020
Calipso
Cam göbeği



RAL 0808010
Sand
Kum beji



RAL 0958010
Light mink
Açık vizon



RAL 1007010
Light khaki
Açık haki



RAL 0008000
Grey
Gri



RAL 0007500
Greige
Grej



RAL 2307015
Pool blue
Havuz mavisi



RAL 0005500
Dark grey
Koyu gri



RAL 1008080
Lime green
Limon yeşili



RAL 0808060
Yellow / sarı
Matt / Mat
RAL 1018
Glossy / Parlak



RAL 0757070
Dark yellow
Koyu sarı



RAL 2006020
Turquoise
Turkuaz



RAL 0806005
Dark greige
Koyu grej



RAL 0206005
Whisper lilac
Leylak



RAL 0606020
Soft brown
Tatlı kahve



RAL 2606030
Cool blue
Soğuk mavi



RAL 2306020
Blue
Mavi



RAL 1105050
Green
Yeşil



RAL 0706040
Ochre yellow
Toprak sarısı



RAL 2003
Matt / Mat
Orange / turuncu
RAL 2010
Glossy / Parlak



RAL 0505010
Dark mink
Koyu vizon



RAL 2205005
Prussian blue
Prusya mavisi



RAL 2004030
Dark turquoise
Koyu turkuaz



RAL 0504040
Tobacco
Taba



RAL 0404005
Basalt brown
Bazalt kahve



RAL 0004000
Anthracite
Antrasit



RAL 0304050
Red / kırmızı
Matt / Mat
RAL 3000
Glossy / Parlak



RAL 2404020
Ocean blue
Okyanus mavisi



RAL 2603035
Aqua blue
Göl mavisi



RAL 5002
Cobalt blue
Kobalt mavi



RAL 3004
Burgundy
Bordo



RAL 2904015
Plum
Mürdüm



RAL 0001500
Black
Siyah

Warm colors / Sıcak renkler

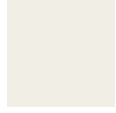

RAL 1009005
Ultra white
Ultra beyaz

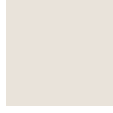

RAL 0809005
Cream
Krem



RAL 0809010
Light sand
Açık kum beji



RAL 0808010
Sand
Kum beji



RAL 0958010
Light mink
Açık vizon



RAL 1007010
Light khaki
Açık haki



RAL 0007500
Greige
Grej



RAL 0606020
Soft brown
Tatlı kahve



RAL 0706040
Ochre yellow
Toprak sarısı



RAL 1008080
Lime green
Limon yeşili



RAL 0808060
Yellow / yellow
Matt / Mat
RAL 1018
Glossy / Parlak



RAL 0757070
Dark yellow
Koyu sarı



RAL 2003
Orange / turuncu
Matt / Mat
RAL 2010
Glossy / Parlak



RAL 1105050
Green
Yeşil



RAL 0505010
Dark mink
Koyu vizon



RAL 0504040
Tobacco
Taba



RAL 3004
Burgundy
Bordo



RAL 0304050
Red / kırmızı
Matt / Mat
RAL 3000
Glossy / Parlak



RAL 0404005
Basalt brown
Bazalt kahve

Cold colors / Soğuk renkler



RAL 9016
White
Beyaz



RAL 7047
Light grey
Açık gri



RAL 0005500
Dark grey
Koyu gri



RAL 0008000
Grey
Gri



RAL 0806005
Dark greige
Koyu grej



RAL 0206005
Whisper lilac
Leylak



RAL 0004000
Anthracite
Antrasit



RAL 2205005
Prussian blue
Prusya mavisi



RAL 0001500
Black
Siyah



RAL 2904015
Plum
Mürdüm



RAL 2008020
Calipso
Cam göbeği



RAL 2307015
Pool blue
Havuz mavisi



RAL 2006020
Turquoise
Turkuaz



RAL 2004030
Dark turquoise
Koyu turkuaz



RAL 2606030
Cool blue
Soğuk mavi



RAL 2306020
Blue
Mavi



RAL 2404020
Ocean blue
Okyanus mavisi



RAL 2603035
Aqua blue
Göl mavisi



RAL 5002
Cobalt blue
Kobalt mavi

Color

Basic

Glazed / Sırlı



RAL 9016
White
Beyaz

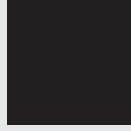

RAL 0001500
Black
Siyah



RAL 1105050
Green
Yeşil



RAL 1008080
Lime green
Limon yeşili



RAL 0808060
Yellow
Sarı
Matt / Mat

RAL 1018
Glossy / Parlak

Fullbody / Sırsız



Uni super white
Uni süper beyaz
Matt / Mat

Neutral

Glazed / Sırlı



RAL 1009005
Ultra white
Ultra beyaz

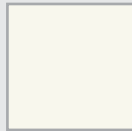

RAL 0809005
Cream
Krem



RAL 0809010
Light sand
Açık kum beji

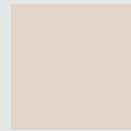

RAL 0808010
Sand
Kum beji

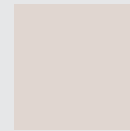

RAL 0958010
Light mink
Açık vizon

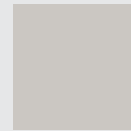

RAL 0007500
Greige
Grej

Fullbody / Sırsız

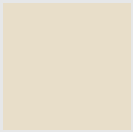

Uni ivory
Uni fildişi
Matt / Mat

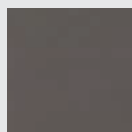

Uni dark mink
Uni koyu vizon
Matt / Mat

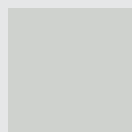

Uni silver
Uni gümüşü
Matt / Mat

Color and Function matching table Color ve Function uyum tablosu



RAL 0757070
Dark yellow
Koyu sarı



RAL 2003
Orange
Turuncu
Matt / Mat

RAL 2010
Glossy / Parlak



RAL 0304050
Red
Kırmızı
Matt / Mat

RAL 3000
Glossy / Parlak



RAL 0806005
Dark greige
Koyu grej



RAL 0505010
Dark mink
Koyu vizon

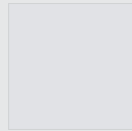

RAL 7047
Light grey
Açık gri

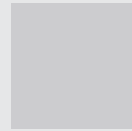

RAL 0008000
Grey
Gri



RAL 0005500
Dark grey
Koyu gri



RAL 0004000
Anthracite
Antrasit



Uni cement grey
Uni çimento gri
Matt / Mat

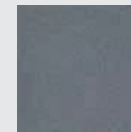

Uni grey
Uni gri
Matt / Mat



Uni black
Uni siyah
Matt / Mat

Color

Complementary pieces
Tamamlayıcı parçalar



PRO

Technic

Porcelain tiles / Porselen karolar

Body type / Bünye tipi

Glazed porcelain / Sırlı porselen

Surface alternatives / Yüzey alternatifleri

Matt / Mat

Glossy / Parlak

Base tile colors / Fon renkleri

White / Beyaz, RAL 9016

Black / Siyah, RAL 0001500

Cream / Krem, RAL 0809005

Light pink / Açık vizon, RAL 0958010

Greige / Grej, RAL 0007500

Light grey / Açık gri, RAL 7047

Dark grey / Koyu gri, RAL 0005500

Usage areas / Kullanım alanları

Commercial area / Ticari alan

Industrial area / Endüstriyel alan

Tiling areas / Döşeme alanları

Floor / Yer

Wall / Duvar

Frost resistance / Dona dayanım

Available / Var

Shade variation classification / Desen farklılaşması

Vo

Product standard / Ürün standardı

EN14411 Group B1a

Porcelain tiles / Porselen karolar

Complementary pieces

Integrated solutions

PRO Color complementary pieces provide covering solutions for edges and corners in 6 colors. These parts ensure aesthetic appearance and ease of cleaning and are very suitable for all kinds of wet areas such as bathrooms, kitchens and Industrial areas. Moreover, thanks to their modular structure, they can be used with all products available in PRO Color and PRO Function ranges.

Tamamlayıcı parçalar

Bütünsel çözümler

PRO Color 6 renkte kenar ve köşe dönüşleri için kaplama çözümleri sunar. Estetiğin yanı sıra temizlik imkânı da sağlayan parçalar; hem banyo, mutfak gibi ıslak alanlarda hem de endüstriyel mekânlarda kullanıma uygundur. Üstelik modüler yapıları sayesinde PRO Function ve PRO Color ürünleriyle birlikte kullanılabilir.



Porcelain
Porselen



Floor tile
Yer karosu



Wall tile
Duvar karosu



Pool surrounding
Havuz çevresi



Outdoors
Dış mekânlar



Industrial area
Endüstriyel alan



Commercial
Ticari alan



Frost resistance
Dona dayanım



Shade variation
Desen farklılaşması









Matt
Mat















Glossy
Parlak

Color

Complementary pieces Tamamlayıcı parçalar

Colors / Renkler	Right angled sit-in set / köşeli dönüş parçaları sit-in					
	2x20	2x20	3x10	2x10	10x10	10x20
	Internal beading	External beading	Covebase external corner	Covebase internal corner	Covebase	Covebase
	İç profil	Dış profil	Dış köşe dönüş parçası	İç köşe dönüş parçası	Kenar dönüş parçası	Kenar dönüş parçası
	6 mm	6 mm	6 mm	6 mm	6 mm	6 mm
Matt / Mat	Matt / Mat	Matt / Mat	Matt / Mat	Matt / Mat	Matt / Mat	
						
RAL 9016 White / Beyaz	K94953600001VTE0	K94954200001VTE0	K94951800001VTE0	K94951200001VTE0	K94952400001VTE0	K94953000001VTE0
RAL 0001500 Black / Siyah	K94953700001VTE0	K94954300001VTE0	K94951900001VTE0	K94951300001VTE0	K94952500001VTE0	K94953100001VTE0
RAL 0809005 Cream / Krem	K94953800001VTE0	K94954400001VTE0	K94952000001VTE0	K94951400001VTE0	K94952600001VTE0	K94953200001VTE0
RAL 7500 Greige / Grej	K94953900001VTE0	K94954500001VTE0	K94952100001VTE0	K94951500001VTE0	K94952700001VTE0	K94953300001VTE0
RAL 7047 Light grey / Açık gri	K94954000001VTE0	K94954600001VTE0	K94952200001VTE0	K94951600001VTE0	K94952800001VTE0	K94953400001VTE0
RAL 0005500 Dark grey / Koyu gri	K94954100001VTE0	K94954700001VTE0	K94952300001VTE0	K94951700001VTE0	K94952900001VTE0	K94953500001VTE0
RAL 0958010 Light mink / Açık vizon	K94955100001VTE0	K94955200001VTE0	K94955000001VTE0	K94954900001VTE0	K94947400001VTE0	K94947500001VTE0

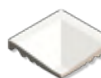
Colors / Renkler	All Round					
	5x10	5x10	10x10	10x10	5x5	5x5
	External beading	Internal beading	Down-out external corner	Up-in internal corner	Up-out external corner	Down-in internal corner
	Dış profil	İç profil	Alt-dış köşe parçası	Üst-iç köşe parçası	Üst-dış köşe parçası	Alt-iç köşe parçası
	6 mm	6 mm	6 mm	6 mm	6 mm	6 mm
Glossy / Parlak	Glossy / Parlak	Glossy / Parlak	Glossy / Parlak	Glossy / Parlak	Glossy / Parlak	
						
RAL 9016 White / Beyaz	K94955700001VTE0	K94955300001VTE0	K94956100001VTE0	K94956500001VTE0	K94956900001VTE0	K94957300001VTE0
RAL 0001500 Black / Siyah	K94955800001VTE0	K94955400001VTE0	K94956200001VTE0	K94956600001VTE0	K94957000001VTE0	K94957400001VTE0
RAL 0005500 Dark grey / Koyu gri	K94956000001VTE0	K94955600001VTE0	K94956400001VTE0	K94956800001VTE0	K94957200001VTE0	K94957600001VTE0
RAL 0958010 Light mink / Açık vizon	K94955900001VTE0	K94955500001VTE0	K94956300001VTE0	K94956700001VTE0	K94957100001VTE0	K94957500001VTE0

Colors / Renkler	Covebase bullnose set / Kenar dönüş ve yuvarlak kenarlı bitiş parçaları				Shower inclined edge / Duş parçaları		
	5x5	5x5	5x5	5x5	10x10	10x10	10x10
	Covebase	Covebase internal corner	Bullnose	Bullnose corner	Shower inclined end Edge	Shower inclined end edge internal	Shower inclined end edge external
	Kenar dönüş parçası	Çift kenar dönüş parçası	Bullnose	Bullnose köşe	Duş parçası	Duş parçası iç köşe	Duş parçası dış köşe
	6 mm	6 mm	6 mm	6 mm	6/14 mm	6/14 mm	6/14 mm
Matt / Mat	Matt / Mat	Matt / Mat	Matt / Mat	R10B	R10B	R10B	
							
RAL 9016 White / Beyaz	K78570430001VTE0	K78568200001VTE0	K78566070001VTE0	K51648600001VTE0	K78250500001VTE0	K78251600001VTE0	K78252000001VTE0
RAL 0001500 Black / Siyah	K94828530001VTE0	K94828900001VTE0	K53919270001VTE0	K53932100001VTE0	K94827800001VTE0	K94828000001VTE0	K94828200001VTE0
RAL 0809005 Cream / Krem	K94828630001VTE0	K94829000001VTE0	K53913370001VTE0	K53927300001VTE0	K94827900001VTE0	K94828100001VTE0	K94828300001VTE0
RAL 7500 Greige / Grej	K94828730001VTE0	K94829100001VTE0	K94829670001VTE0	K94954800001VTE0	K85713000001VTE0	K85714100001VTE0	K79041000001VTE0
RAL 7047 Light grey / Açık gri	K94828430001VTE0	K79106200001VTE0	K79104070001VTE0	K53922500001VTE0	K78428100001VTE0	K78429200001VTE0	K78430300001VTE0
RAL 0005500 Dark grey / Koyu gri	K94828830001VTE0	K94829200001VTE0	K53916670001VTE0	K53928400001VTE0	K89370400001VTE0	K89373000001VTE0	K89376300001VTE0

* For the compatibility of the products to be used with complementary parts, a special order note should be added requesting the simultaneous production of all tiles. There may be a color tone difference in products produced at different times.

Tamamlayıcı parçalar ile birlikte döşenecek ürünlerin uyumu için özel sipariş notu düşülmeli ve birlikte üretim yapılmalıdır. Farklı zamanlarda üretilen ürünlerde renk tonu farkı olabilir.

Color

Right angled sit-in set 6mm
Köşeli dönüş parçaları sit-in 6mm

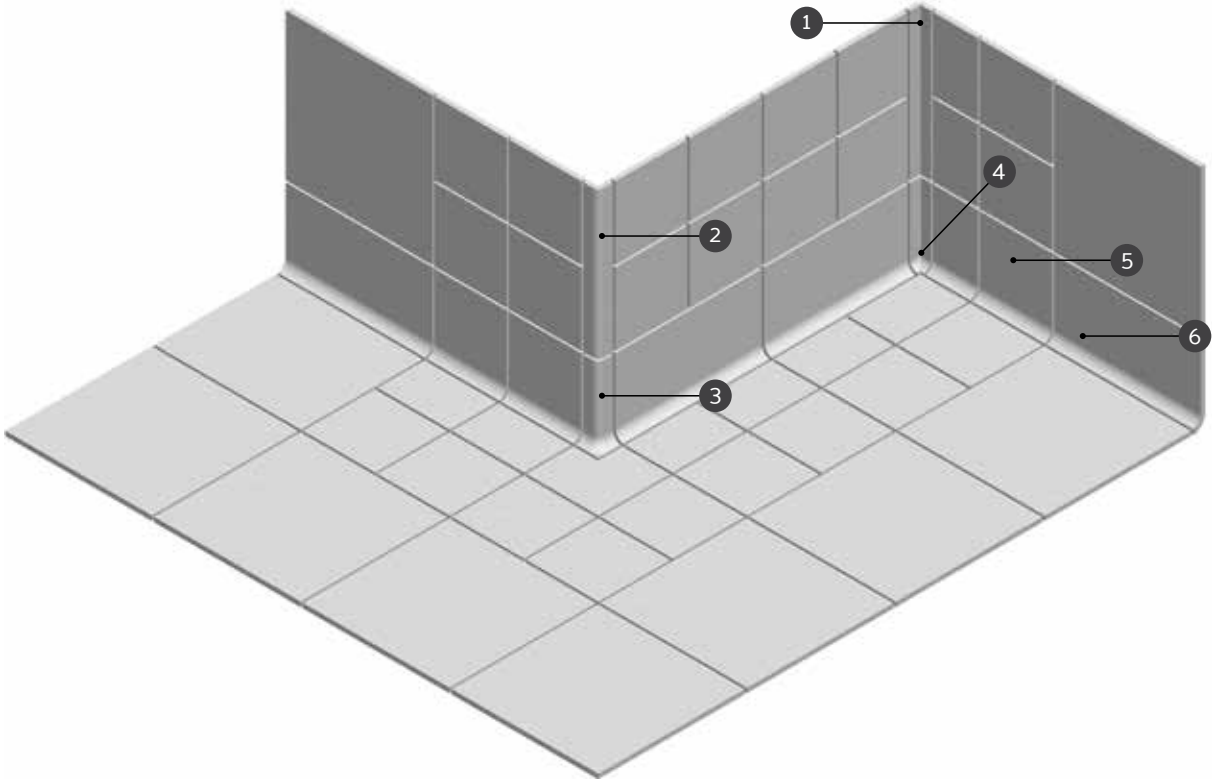

1 Internal beading sit-in
İç profil sit-in

2 External beading sit-in
Dış profil sit-in

3 Covebase external corner sit-in
Dış köşe dönüş parçası sit-in

4 Covebase internal corner sit-in
İç köşe dönüş parçası sit-in

5 Covebase sit-in
Kenar dönüş parçası sit-in

6 Covebase sit-in
Kenar dönüş parçası sit-in

Complementary pieces Tamamlayıcı parçalar

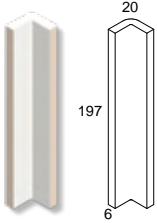

Internal beading sit-in

İç profil sit-in

M 2 x 20 cm / 1"x 8"

6mm

IP220



White / Beyaz
RAL 9016
Matt / Mat
K94953600001VTE0



Greige / Grej
RAL 0007500
Matt / Mat
K94953900001VTE0



Black / Siyah
RAL 0001500
Matt / Mat
K94953700001VTE0



Light grey / Açık gri
RAL 7047
Matt / Mat
K94954000001VTE0



Cream / Krem
RAL 0809005
Matt / Mat
K94953800001VTE0



Dark grey / Koyu gri
RAL 5500
Matt / Mat
K94954100001VTE0

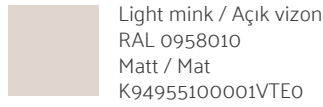

Light mink / Açık vizon
RAL 0958010
Matt / Mat
K94955100001VTE0

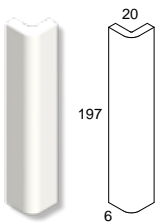

External beading sit-in

Dış profil sit-in

M 2 x 20 cm / 1"x 8"

6mm

DP220



White / Beyaz
RAL 9016
Matt / Mat
K94954200001VTE0



Greige / Grej
RAL 0007500
Matt / Mat
K94954500001VTE0



Black / Siyah
RAL 0001500
Matt / Mat
K94954300001VTE0



Light grey / Açık gri
RAL 7047
Matt / Mat
K94954600001VTE0



Cream / Krem
RAL 0809005
Matt / Mat
K94954400001VTE0



Dark grey / Koyu gri
RAL 5500
Matt / Mat
K94954700001VTE0



Light mink / Açık vizon
RAL 0958010
Matt / Mat
K94955200001VTE0

Color

Right angled sit-in set 6mm
Köşeli dönüş parçaları sit-in 6mm

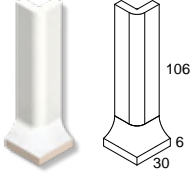

Covebase external corner sit-in

Dış köşe dönüş parçası sit-in

M 3 x 10 cm / 1"x 4"

6mm

DKI310



White / Beyaz
RAL 9016
Matt / Mat
K94951800001VTEO



Greige / Grej
RAL 0007500
Matt / Mat
K94952100001VTEO



Black / Siyah
RAL 0001500
Matt / Mat
K94951900001VTEO



Light grey / Açık gri
RAL 7047
Matt / Mat
K94952200001VTEO



Cream / Krem
RAL 0809005
Matt / Mat
K94952000001VTEO



Dark grey / Koyu gri
RAL 5500
Matt / Mat
K94952300001VTEO

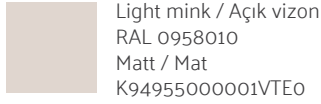

Light mink / Açık vizon
RAL 0958010
Matt / Mat
K94955000001VTEO

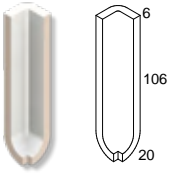

Covebase internal corner sit-in

İç köşe dönüş parçası sit-in

M 2 x 10 cm / 1"x 4"

6mm

IK210

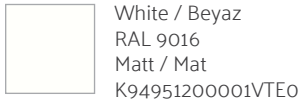

White / Beyaz
RAL 9016
Matt / Mat
K94951200001VTEO



Greige / Grej
RAL 0007500
Matt / Mat
K94951500001VTEO



Black / Siyah
RAL 0001500
Matt / Mat
K94951300001VTEO



Light grey / Açık gri
RAL 7047
Matt / Mat
K94951600001VTEO



Cream / Krem
RAL 0809005
Matt / Mat
K94951400001VTEO



Dark grey / Koyu gri
RAL 5500
Matt / Mat
K94951700001VTEO



Light mink / Açık vizon
RAL 0958010
Matt / Mat
K94954900001VTEO

Complementary pieces Tamamlayıcı parçalar

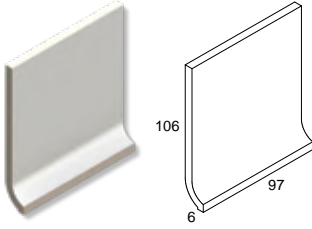

Covebase sit-in
Kenar dönüş parçası sit-in
M 10 x 10 cm / 4"x 4"
6mm
KDI1010



White / Beyaz
RAL 9016
Matt / Mat
K94952400001VTE0



Greige / Grej
RAL 0007500
Matt / Mat
K94952700001VTE0



Black / Siyah
RAL 0001500
Matt / Mat
K94952500001VTE0



Light grey / Açık gri
RAL 7047
Matt / Mat
K94952800001VTE0



Cream / Krem
RAL 0809005
Matt / Mat
K94952600001VTE0



Dark grey / Koyu gri
RAL 5500
Matt / Mat
K94952900001VTE0



Light mink / Açık vizon
RAL 0958010
Matt / Mat
K94947400001VTE0

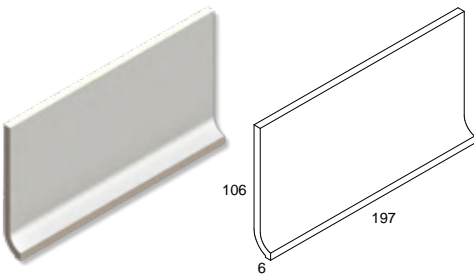

Covebase sit-in
Kenar dönüş parçası sit-in
M 10 x 20 cm / 4"x 8"
6mm
KDI1020



White / Beyaz
RAL 9016
Matt / Mat
K94953000001VTE0



Greige / Grej
RAL 0007500
Matt / Mat
K94953300001VTE0



Black / Siyah
RAL 0001500
Matt / Mat
K94953100001VTE0



Light grey / Açık gri
RAL 7047
Matt / Mat
K94953400001VTE0



Cream / Krem
RAL 0809005
Matt / Mat
K94953200001VTE0



Dark grey / Koyu gri
RAL 5500
Matt / Mat
K94953500001VTE0



Light mink / Açık vizon
RAL 0958010
Matt / Mat
K94947500001VTE0

Color

All Round



Complementary pieces Tamamlayıcı parçalar

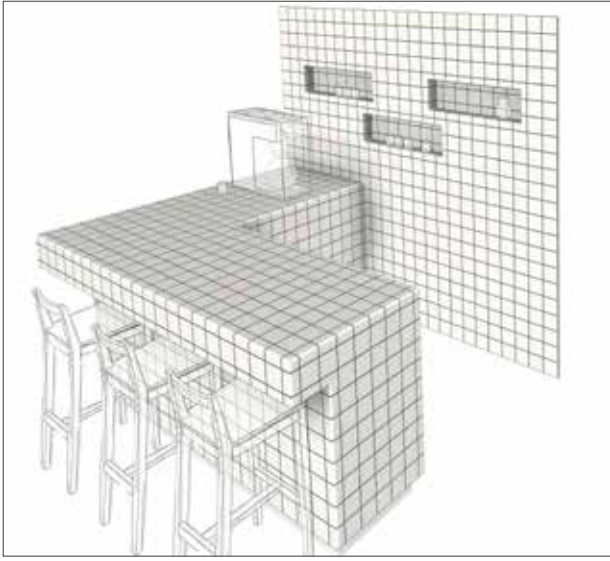

Cafe bar / Kafe bar

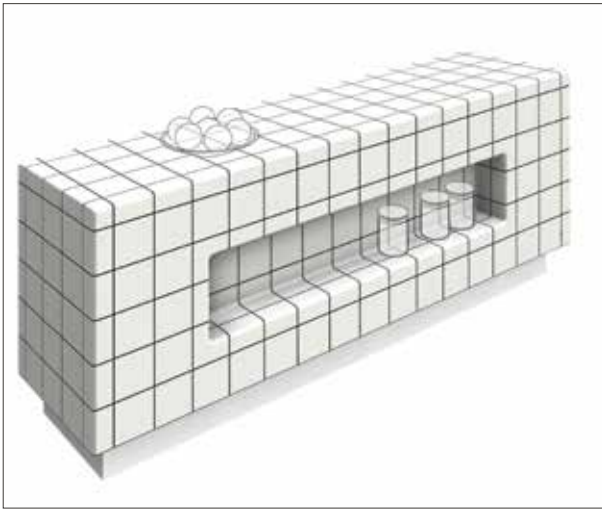

Cafe island bar / Kafe ada bar

All Round

VitrA, offers complementary solutions for edges and corners in 4 colours and 6 forms. The parts that ensure aesthetic appearance and ease of cleaning are very suitable for all kinds of residential areas such as bathroom and kitchen as well as public bathroom, café and bar.

VitrA, 4 renk ve 6 formda kenar ve köşe dönüřlerini yumuřatan çözümler sunuyor. Estetiđin yanı sıra kolay temizlik imkânı da sađlayan parçalar; hem banyo, mutfak gibi rezidansiyel alanlarda hem de kamusal tuvalet, kafe, bar gibi mekânlarda kullanıma uygundur.

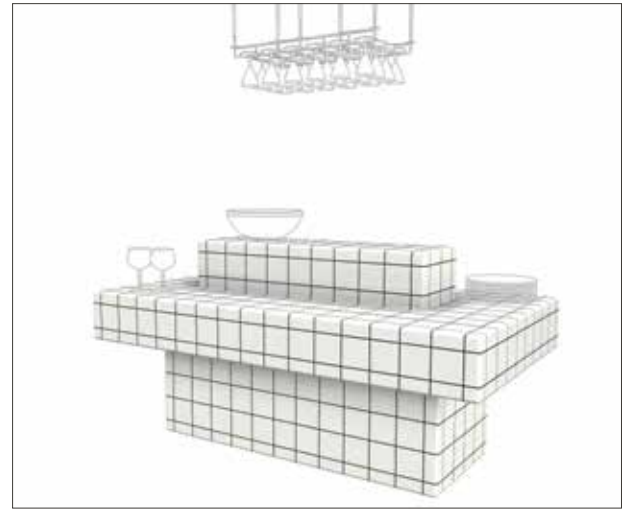

Cocktail bar / Kokteyl bar

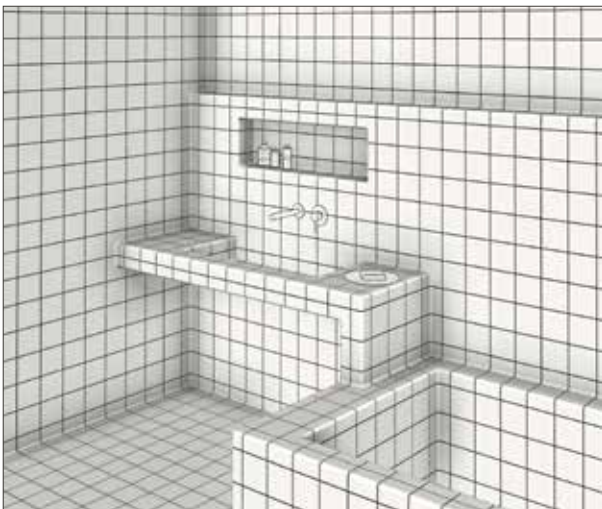

Bathroom / Banyo

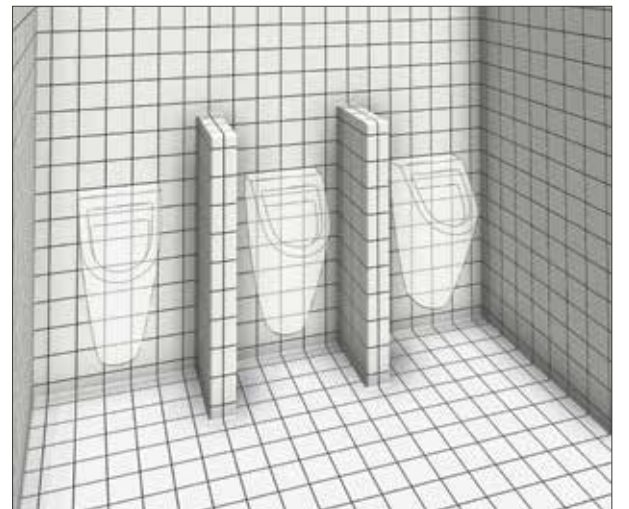

Public restrooms / Kamusal tuvaletler

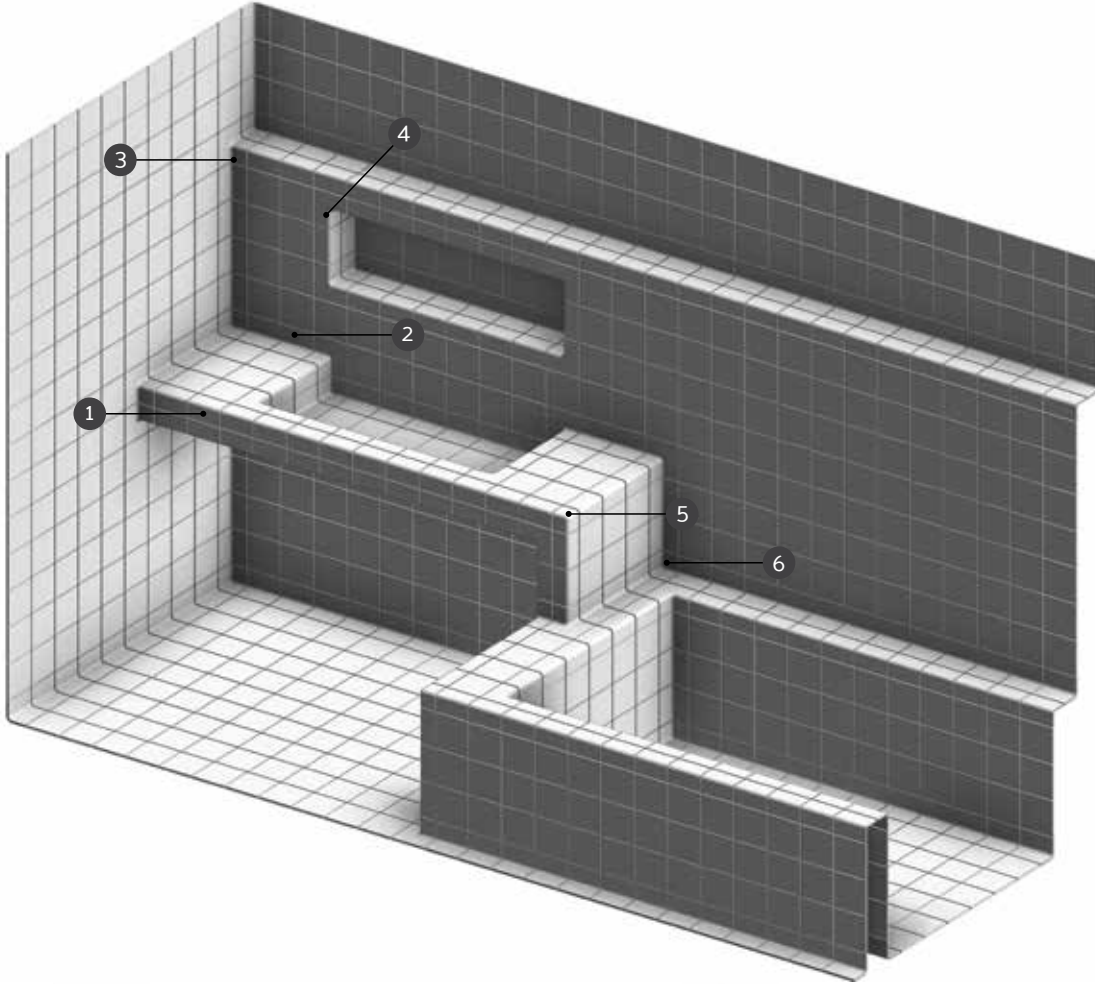

1 External beading
Dış profil

2 Internal beading
İç profil

3 Down-out external corner
Alt dış köşe parçası

4 Up-in internal corner
Üst iç köşe parçası

5 Up-out external corner
Üst dış köşe parçası

6 Down-in internal corner
Alt iç köşe parçası

Complementary pieces Tamamlayıcı parçalar

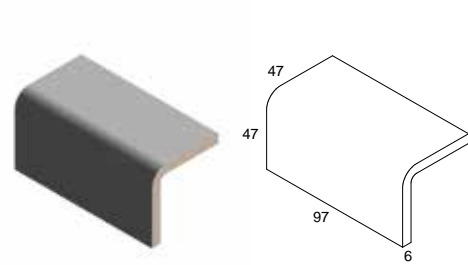

External beading

Dış profil

M 5 x 10 cm / 2"x 4"

6mm

DP510

White / Beyaz
RAL 9016
Glossy / Parlak
K94955700001VTE0

Dark grey / Koyu gri
RAL 5500
Glossy / Parlak
K94956000001VTE0

Black / Siyah
RAL 0001500
Glossy / Parlak
K94955800001VTE0

Light mink / Açık vizon
RAL 0958010
Glossy / Parlak
K94955900001VTE0

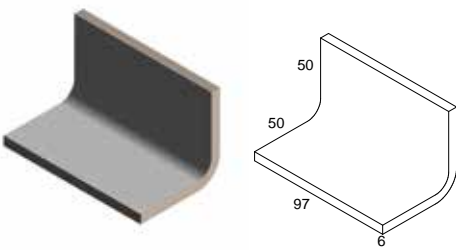

Internal beading

İç profil

M 5 x 10 cm / 2"x4"

6mm

IP510

White / Beyaz
RAL 9016
Glossy / Parlak
K94955300001VTE0

Dark grey / Koyu gri
RAL 5500
Glossy / Parlak
K94955600001VTE0

Black / Siyah
RAL 0001500
Glossy / Parlak
K94955400001VTE0

Light mink / Açık vizon
RAL 0958010
Glossy / Parlak
K94955500001VTE0

Color

All Round

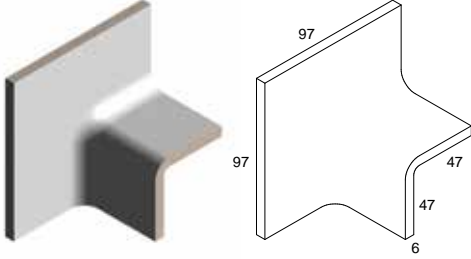

Down-out external corner

Alt dış köşe parçası

M 10 x 10 cm / 4"x 4"

6mm

ADK1010

White / Beyaz
RAL 9016
Glossy / Parlak
K94956100001VTE0

Black / Siyah
RAL 0001500
Glossy / Parlak
K94956200001VTE0

Dark grey / Koyu gri
RAL 5500
Glossy / Parlak
K94956400001VTE0

Light mink / Açık vizon
RAL 0958010
Glossy / Parlak
K94956300001VTE0

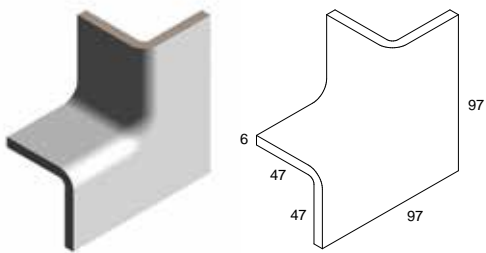

Up-in internal corner

Üst iç köşe parçası

M 10 x 10 cm / 4"x 4"

6mm

UIK1010

White / Beyaz
RAL 9016
Glossy / Parlak
K94956500001VTE0

Black / Siyah
RAL 0001500
Glossy / Parlak
K94956600001VTE0

Dark grey / Koyu gri
RAL 5500
Glossy / Parlak
K94956800001VTE0

Light mink / Açık vizon
RAL 0958010
Glossy / Parlak
K94956700001VTE0

Complementary pieces Tamamlayıcı parçalar

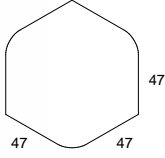

Up-out external corner

Üst dış köşe parçası

M 5 x 5 cm / 2"x 2"

6mm

UDK55



White / Beyaz
RAL 9016
Glossy / Parlak
K94956900001VTE0



Dark grey / Koyu gri
RAL 5500
Glossy / Parlak
K94957200001VTE0



Black / Siyah
RAL 0001500
Glossy / Parlak
K94957000001VTE0



Light mink / Açık vizon
RAL 0958010
Glossy / Parlak
K94957100001VTE0

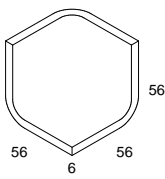

Down-in internal corner

Alt iç köşe parçası

M 5 x 5 cm / 2"x 2"

6mm

AIK55



White / Beyaz
RAL 9016
Glossy / Parlak
K94957300001VTE0



Dark grey / Koyu gri
RAL 5500
Glossy / Parlak
K94957600001VTE0



Black / Siyah
RAL 0001500
Glossy / Parlak
K94957400001VTE0





Light mink / Açık vizon
RAL 0958010
Glossy / Parlak
K94957500001VTE0

Color

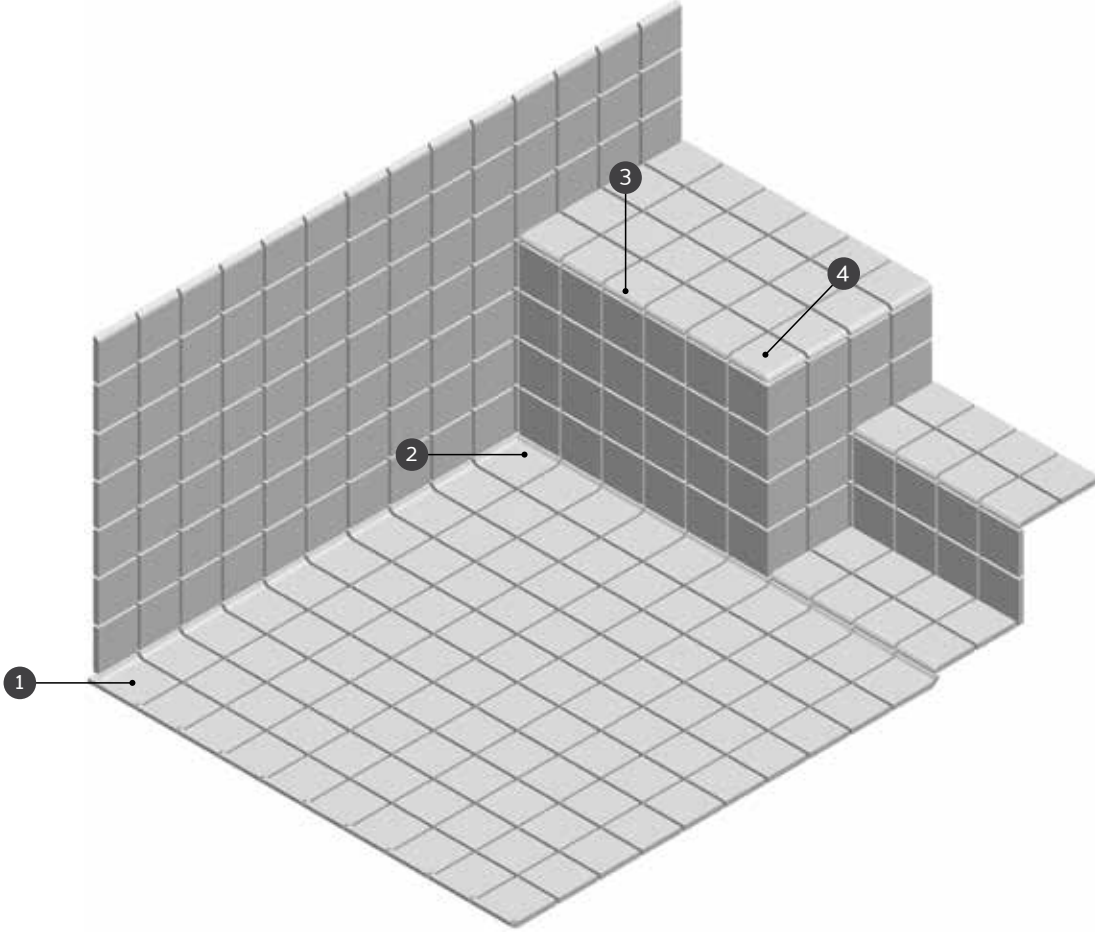
Covebase bullnose set 6mm
Kenar dönüş ve yuvarlak kenarlı bitiş parçaları 6mm



1  Covebase
Kenar dönüş parçası

2  Covebase internal corner
Çift kenar dönüş parçası

3  Bullnose
Bullnose

4  Bullnose corner
Bullnose köşe

Complementary pieces Tamamlayıcı parçalar

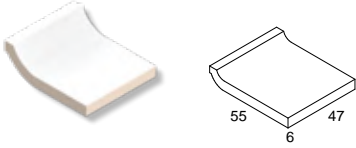

Covebase
Kenar dönüş parçası
M 5 x 5 cm / 2"x 2"
6mm
KDY55

White / Beyaz
RAL 9016
Matt / Mat
K78570430001VTE0

Black / Siyah
RAL 0001500
Matt / Mat
K94828530001VTE0

Cream / Krem
RAL 0809005
Matt / Mat
K94828630001VTE0

Greige / Grej
RAL 0007500
Matt / Mat
K94828730001VTE0

Light grey / Açık gri
RAL 7047
Matt / Mat
K94828430001VTE0

Dark grey / Koyu gri
RAL 5500
Matt / Mat
K94828830001VTE0

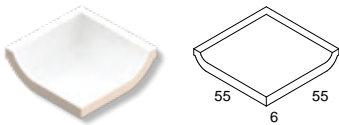

Covebase internal corner
Çift kenar dönüş parçası
M 5 x 5 cm / 2"x 2"
6mm
CKD55

White / Beyaz
RAL 9016
Matt / Mat
K78568200001VTE0

Black / Siyah
RAL 0001500
Matt / Mat
K94828900001VTE0

Cream / Krem
RAL 0809005
Matt / Mat
K94829000001VTE0

Greige / Grej
RAL 0007500
Matt / Mat
K94829100001VTE0

Light grey / Açık gri
RAL 7047
Matt / Mat
K79106200001VTE0

Dark grey / Koyu gri
RAL 5500
Matt / Mat
K94829200001VTE0

Color

Covebase bullnose set 6mm
Kenar dönüş ve yuvarlak kenarlı bitiş parçaları 6mm

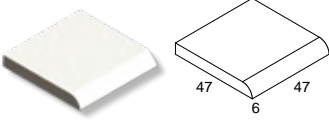

Bullnose

Bullnose

M 5 x 5 cm / 2"x 2"

6mm

S886



White / Beyaz
RAL 9016
Matt / Mat
K78566070001VTEO



Greige / Grej
RAL 0007500
Matt / Mat
K94829670001VTEO



Black / Siyah
RAL 0001500
Matt / Mat
K53919270001VTEO



Light grey / Açık gri
RAL 7047
Matt / Mat
K79104070001VTEO



Cream / Krem
RAL 0809005
Matt / Mat
K53913370001VTEO



Dark grey / Koyu gri
RAL 5500
Matt / Mat
K53916670001VTEO



Bullnose corner

Bullnose köşe

M 5 x 5 cm / 2"x 2"

6mm

SC886



White / Beyaz
RAL 9016
Matt / Mat
K51648600001VTEO



Greige / Grej
RAL 0007500
Matt / Mat
K94954800001VTEO



Black / Siyah
RAL 0001500
Matt / Mat
K53932100001VTEO



Light grey / Açık gri
RAL 7047
Matt / Mat
K53922500001VTEO



Cream / Krem
RAL 0809005
Matt / Mat
K53927300001VTEO



Dark grey / Koyu gri
RAL 5500
Matt / Mat
K53928400001VTEO

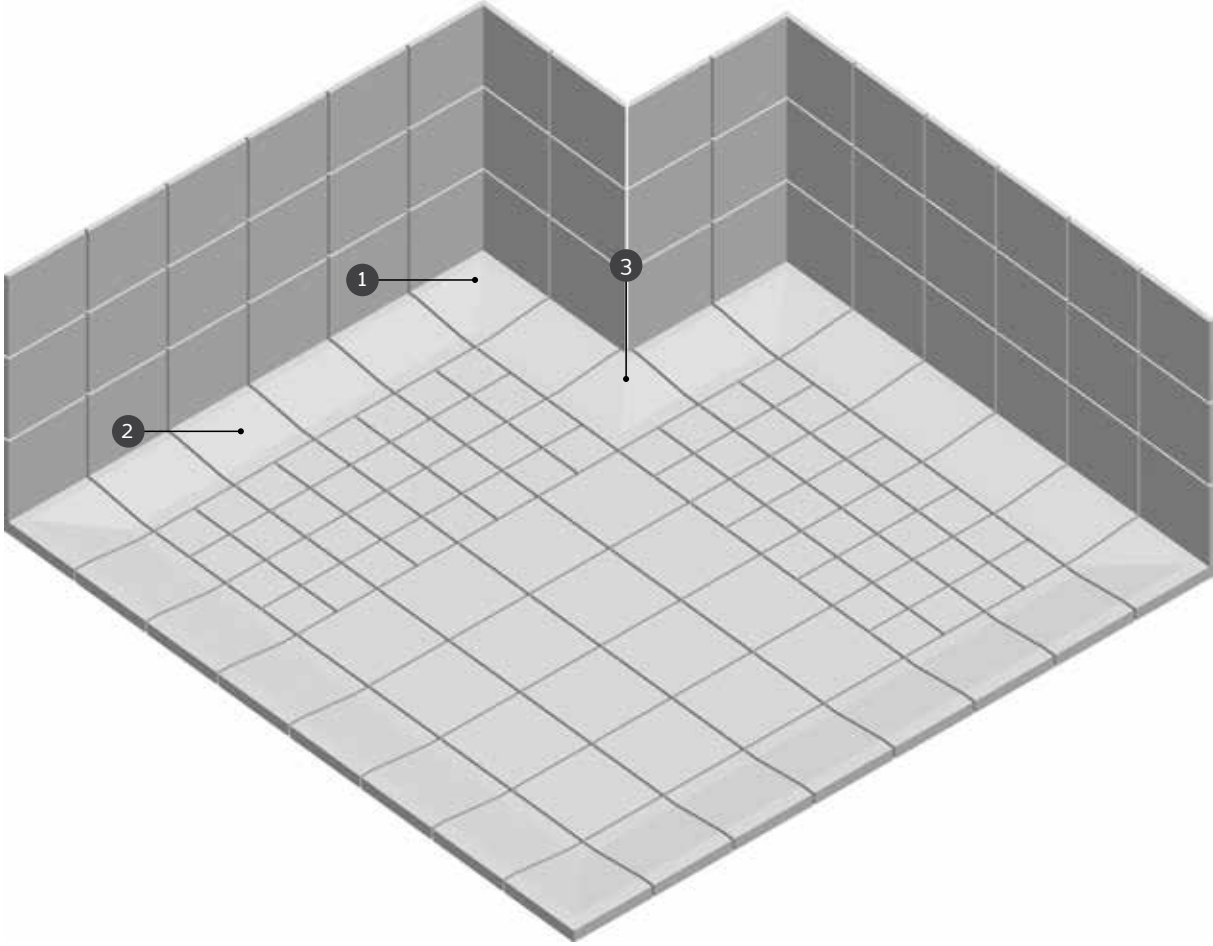

1 Shower inclined end edge internal
Duş parçası iç köşe

2 Shower inclined end edge
Duş parçası

3 Shower inclined end edge external
Duş parçası dış köşe

Color

Shower inclined edge Duş parçaları

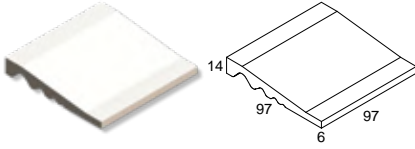

Shower inclined end edge

Duş parçası

M 10 x 10 cm / 4"x 4"

6 mm / 14mm

DUP

White / Beyaz
RAL 9016
R10B
K78250500001VTEO

Black / Siyah
RAL 0001500
R10B
K94827800001VTEO

Cream / Krem
RAL 0809005
R10B
K94827900001VTEO

Greige / Grej
RAL 0007500
R10B
K85713000001VTEO

Light grey / Açık gri
RAL 7047
R10B
K78428100001VTEO

Dark grey / Koyu gri
RAL 5500
R10B
K89370400001VTEO

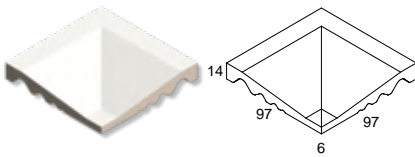

Shower inclined end edge (internal)

Duş parçası iç köşe

M 10 x 10 cm / 4"x 4"

6 mm / 14mm

DUPIK

White / Beyaz
RAL 9016
R10B
K78251600001VTEO

Black / Siyah
RAL 0001500
R10B
K94828000001VTEO

Cream / Krem
RAL 0809005
R10B
K94828100001VTEO

Greige / Grej
RAL 0007500
R10B
K85714100001VTEO

Light grey / Açık gri
RAL 7047
R10B
K78429200001VTEO

Dark grey / Koyu gri
RAL 5500
R10B
K89373000001VTEO

Complementary pieces Tamamlayıcı parçalar

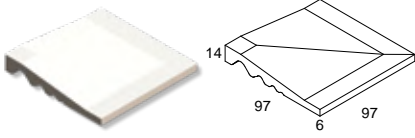

Shower inclined end edge (external)

Duş parçası dış köşe

M 10 x 10 cm / 4"x 4"

6 mm / 14mm

DUPDK

 White / Beyaz
RAL 9016
R10B
K78252000001VTE0

 Black / Siyah
RAL 0001500
R10B
K94828200001VTE0

 Cream / Krem
RAL 0809005
R10B
K94828300001VTE0

 Greige / Grej
RAL 0007500
R10B
K79041000001VTE0

 Light grey / Açık gri
RAL 7047
R10B
K78430300001VTE0

 Dark grey / Koyu gri
RAL 5500
R10B
K89376300001VTE0

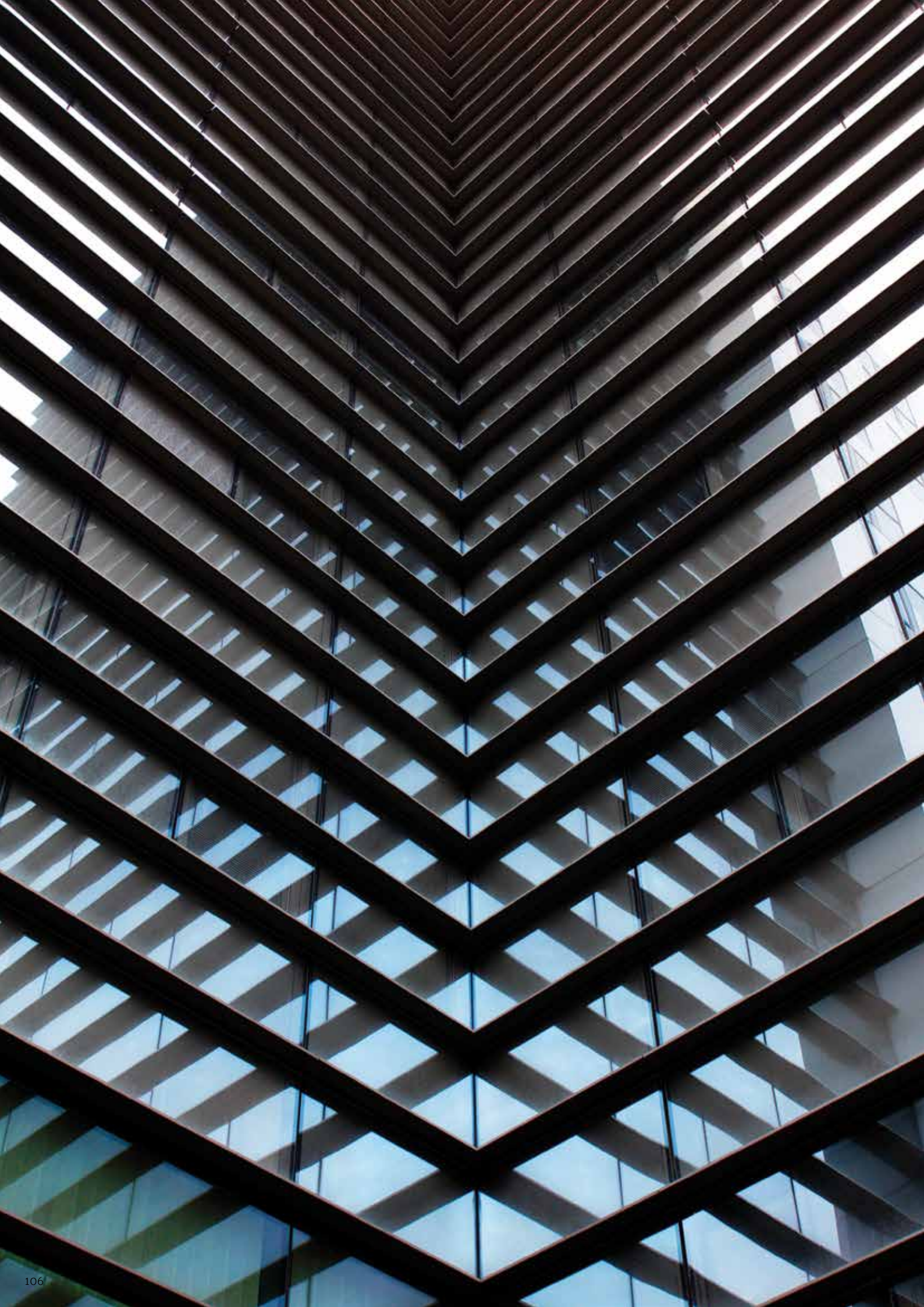

Beyond function

Fonksiyonun ötesinde

A wide range of solutions which meet all requirements of living spaces that keeps changing and with diverse expectations. PRO Function gives you the opportunity to make your dream designs come to fruition even with technical needs.

Yaşayan mekânlar, değişen ihtiyaçlar ve çeşitlenen beklentileri karşılayacak zengin bir çözüm paleti, size hayalinizdeki tasarımı sınırsızca gerçeğe dönüştürme fırsatı sunuyor.

Function

High performance tiles

VitrA PRO Function tiles collection is composed of a wide range of technical products with high performance characteristics. Thanks to their fullbody porcelain body and special surface and thickness options Function tiles have extra resistance against abrasion. Function collection includes two main lines; Uni and Dotti, 7 color options, different surface alternatives, complementary parts, and special surface and thickness offerings. Function special surfaces are offered as a special product group which guarantees effective anti-slip protection with different anti-slip classes needed in Industrial areas, under heavy traffic and excessive load.



Yüksek performanslı karolar

VitrA PRO Function karo koleksiyonu, yüksek performanslarıyla ayrılan teknik ürünlerden oluşmaktadır. Function karoları, fullbody porselen bünyeleri sayesinde aşınmaya karşı ekstra direnç gösterir. Function koleksiyonunda Uni ve Dotti olmak üzere iki temel doku, 7 renk seçeneği, farklı yüzey alternatifleri, tamamlayıcı parçalar, özel yüzey ve kalınlık ihtiyaçlarına uygun ürünler bulunmaktadır. Function özel yüzeyleri, yoğun trafik ve aşırı yük altında olan endüstriyel alanlarda farklı kaymazlık ve kalınlık dereceleri ile kaymaya karşı etkin koruma sağlayan özel bir ürün grubu olarak sunuluyor.

Special surfaces and thickness

Function tiles offer texture and surface options for wide variety of technical application needs. 6 different special surface alternatives are offered; R9, R10A, R10B, Corund - R11B, Mercato - R11B and Diamond - R12V4.

Özel yüzeyler ve kalınlıklar

Function karoları farklı kullanım yeri ihtiyaçlarına uygun doku ve yüzey seçenekleri sunar. Uni ve Dotti doku seçeneklerine sahip koleksiyonda R9, R10A, R10B, Corund - R11B, Mercato - R11B ve Diamond - R12V4 olmak 6 farklı yüzey alternatifinde ürünler bulunmaktadır.



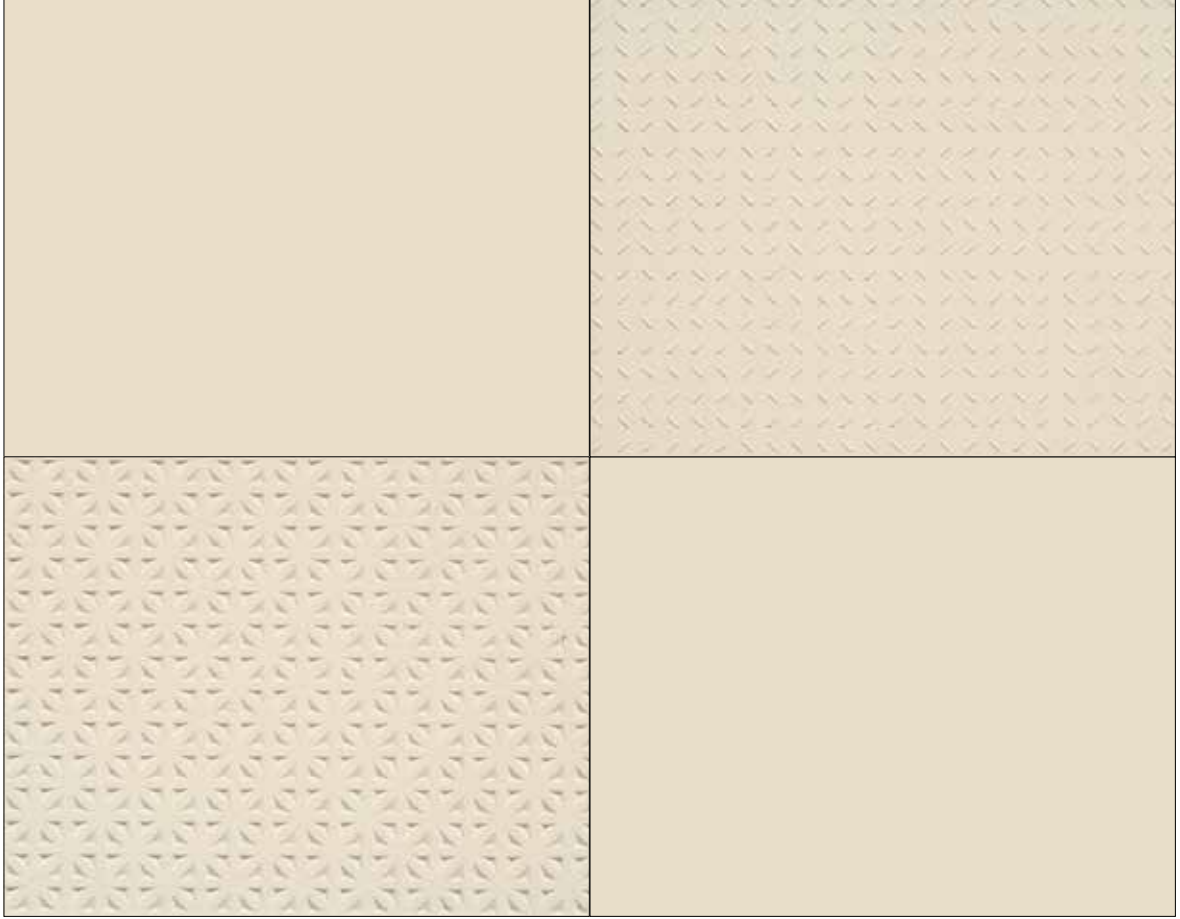

Complementary pieces

Function complementary pieces provide covering solutions in 6 colors for all types of edges and corners. The parts that ensure aesthetic appearance and ease of cleaning and are very suitable for all kinds of wet industrial spaces and for daily use as well. Moreover, thanks to their modular structure, they can be used with all products available in PRO Color and PRO Function ranges.

Tamamlayıcı parçalar

Function 6 renkte kenar ve köşe dönüşleri için kaplama çözümleri sunar. Estetiğin yanı sıra temizlik imkânı da sağlayan parçalar; her türden ıslak ve endüstriyel mekânın yanı sıra, günlük kullanım için de son derece uygun. Üstelik, modüler yapıları sayesinde Function ve Color ürünleriyle birlikte kullanılabilir.



Function

Uni



Function

Fullbody porcelain
Fullbody porselen

Standard surfaces & thickness / Standart yüzey ve kalınlıklar

Series Seri	Color Renk	5x5		10x10		15x15		20x20			30x30			30x60	30x60	60x60
		6mm	6mm	8mm	8mm	8mm	8mm	8mm	9mm	9mm	9mm					
		R10B	R10B	R10B	R9	R10B	R9	R10A	R10B	R9	R10A	R9	R10B	R9		
UNI	Uni super white / Uni süper beyaz															
UNI	Uni silver / Uni gümüş															
UNI	Uni cement grey / Uni çimento gri															
UNI	Uni grey / Uni gri															
UNI	Uni dark mink / Uni koyu vizon															
UNI	Uni black / Uni siyah															
UNI	Uni ivory / Uni fildişi															
DOTS	Dotti ivory / Dotti fildişi															
DOTS	Dotti light grey / Dotti açık gri															
DOTS	Dotti dark grey / Dotti koyu gri															
DOTS	Dotti light beige / Dotti açık bej															
DOTS	Color Dot grey / Color Dot gri															
DOTS	Color Dot dark mink / Color Dot koyu vizon															
DOTS	Color Dot anthracite / Color Dot antrasit															

Special thickness / Özel kalınlıklar

Series Seri	Color Renk	20x20		30x30		60x60	
		12mm	14mm	12mm	14mm		
		R10A	R10A	R10A	R10A		
UNI	Uni super white / Uni süper beyaz						
UNI	Uni silver / Uni gümüş						
UNI	Uni cement grey / Uni çimento gri						
UNI	Uni grey / Uni gri						
UNI	Uni dark mink / Uni koyu vizon						
UNI	Uni black / Uni siyah						
UNI	Uni ivory / Uni fildişi						
DOTS	Dotti ivory / Dotti fildişi						
DOTS	Dotti light grey / Dotti açık gri						
DOTS	Dotti dark grey / Dotti koyu gri						
DOTS	Dotti light beige / Dotti açık bej						
DOTS	Color Dot grey / Color Dot gri						
DOTS	Color Dot dark mink / Color Dot koyu vizon						
DOTS	Color Dot anthracite / Color Dot antrasit						

Function product portfolio Function ürün gamı

Special surfaces / Özel yüzeyler

Series Seri	Color Renk	15x15			20x20						30x30				
		8mm			8mm			12mm			14mm	8mm		12mm	
		MERCATO	CORUND	DIAMOND	MERCATO	CORUND	DIAMOND	MERCATO	CORUND	DIAMOND	MERCATO	MERCATO	CORUND	MERCATO	
		R11B	R11B	R12V4	R11B	R11B	R12V4	R11B	R11B	R12V4	R11B	R11B	R11B	R11B	
UNI	Uni super white / Uni süper beyaz														
UNI	Uni silver / Uni gümüş														
UNI	Uni cement grey / Uni çimento gri														
UNI	Uni grey / Uni gri														
UNI	Uni dark mink / Uni koyu vizon														
UNI	Uni black / Uni siyah														
UNI	Uni ivory / Uni fildişi														
DOTS	Dotti ivory / Dotti fildişi														
DOTS	Dotti light grey / Dotti açık gri														
DOTS	Dotti dark grey / Dotti koyu gri														
DOTS	Dotti light beige / Dotti açık bej														
DOTS	Color Dot grey / Color Dot gri														
DOTS	Color Dot dark mink / Color Dot koyu vizon														
DOTS	Color Dot anthracite / Color Dot antrasit														

* Special surfaces can be used for different purposes and usage areas by choosing different reliefs.

* Özel yüzeyler farklı rölyefler tercih edilerek farklı amaçlara ve kullanım alanlarına uygun olarak kullanılabilir.

Function

Uni





Wall tiles / Duvar karoları : K50738280001VTE0 10x10 Function Uni Super white / Süper beyaz R10B

Floor tiles / Yer karoları : K83552300001VTE0 20x20 Function Uni Grey / Gri R9

Function

Uni





Function

Uni

PRO

Technic

Porcelain tiles / Porselen karolar

Body type / Bünye tipi

Fullbody porcelain / Fullbody porselen

Surface alternatives / Yüzey alternatifleri

R9

R10A

R10B

Corund - R11B

Mercato - R11B

Diamond - R12V4

Base tile sizes / Fon ebatları

M5x5 cm (47x47x6 mm)

M10x10 cm (97x97x6 mm)

M15x15 cm (147x147x8 mm)

M20x20 cm (197x197x8 mm)

M30x30 cm (297x297x8 mm)

M30x60 cm (297x597x9 mm)

M60x60 cm (597x597x9 mm)

Base tile colors / Fon renkleri

Uni super white / Uni süper beyaz

Uni silver / Uni gümüş

Uni ivory / Uni fildişi

Uni dark mink / Uni koyu vizon

Uni grey / Uni gri

Uni cement grey / Uni çimento gri

Uni black / Uni siyah

Kullanım Alanları / Usage Areas

Commercial area / Ticari alan

Industrial area / Endüstriyel alan

Tiling areas / Döşeme alanları

Floor / Yer

Wall / Duvar

Frost resistance / Dona dayanım

Available / Var

Shade variation classification /

Desen farklılaşması

V0

Product standard / Ürün standardı

EN14411 Group B1a:

Fullbody porcelain tiles / Fullbody porselen karolar

Uni

Uni line combines the basic colors of PRO Function collection and offers various color alternatives from warm earthy colors to white hues, and from black to grey color options, in different sizes. Uni tiles offer extra resistance against abrasion with their fullbody porcelain body and are available in 7 different colors and 7 different sizes.

Function koleksiyonunun temel renklerini bir araya getiren Uni ürün ailesi, sıcak toprak renklerinden beyaz tonlarına, siyahtan gri renk seçeneklerine pek çok farklı renk alternatifini farklı ebatlarda sunuyor. Fullbody porselen yapısıyla her türlü aşınmaya karşı ekstra dayanıklılık sunan Uni ürün grubu karoları, 7 farklı renk seçeneğini 7 ayrı ebatta bir araya getiriyor.



Porcelain
Porselen



Floor tile
Yer karosu



Wall tile
Duvar karosu



Facade
Dış cephe



Pool surrounding
Havuz çevresi



Outdoors
Dış mekânlr



Industrial area
Endüstriyel alan



Commercial
Ticari alan



Frost resistance
Dona dayanım



Shade variation
Desen farklılaşması



Matt
Mat



Rectified
Rektifiyeli



Non-rectified
Rektifiyesiz



Modularity
Modülerlik



Garages and car
showrooms
Garajlar ve otomobil
galerileri

Function

Uni



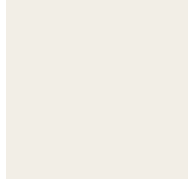

Super white
Süper beyaz

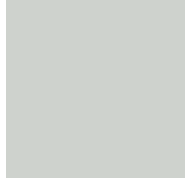

Silver
Gümüş

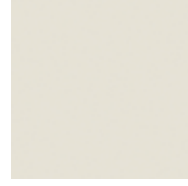

Ivory
Fildişi



Cement grey
Çimento gri



Grey
Gri



Dark mink
Koyu vizon



Black
Siyah

Function

Dots

57 Street & 8 Avenue

Wall tiles / Duvar karoları : K83560400001VTE0 30x30 Function Dotti Dark grey / Koyu gri R9
K83533500001VTE0 20x20 Function Dotti Light grey / Açık gri R9

Floor tiles / Yer karoları : K83559300001VTE0 30x30 Function Dotti Light grey / Açık gri R9



↑ Exit 57 Street

MISSISSAUGA RIVER
Penna Station

MISSISSAUGA RIVER

Function

Dots





Floor tiles / Yer karoları : K83562600001VTE0 30x30 Function Dotti Light beige / Açık bej R9
K85499300001VTE0 30x30 Function Color Dot Dark mink / Koyu vizon R9

Function

Dots

PRO

Technic

Porcelain tiles / Porselen karolar

Body type / Bünye tipi

Fullbody porcelain / Fullbody porselen

Surface alternatives / Yüzey alternatifleri

R9

R10A

R10B

Corund - R11B

Mercato - R11B

Diamond - R12V4

Base tile sizes / Fon ebatları

M5x5 cm (47x47x6 mm)

M10x10 cm (97x97x6 mm)

M15x15 cm (147x147x8 mm)

M20x20 cm (197x197x8 mm)

M30x30 cm (297x297x8 mm)

M30x60 cm (297x597x9 mm)

M60x60 cm (597x597x9 mm)

Base tile colors / Fon renkleri

Dotti ivory / Dotti fildişi

Dotti light beige / Dotti açık bej

Dotti light grey / Dotti açık gri

Dotti dark grey / Dotti koyu gri

Color Dot koyu vizon / Color Dot dark mink

Color Dot gri / Color Dot grey

Color Dot antrasit / Color Dot anthracite

Usage areas / Kullanım alanları

Commercial area / Ticari alan

Industrial area / Endüstriyel alan

Tiling areas / Döşeme alanları

Floor / Yer

Wall / Duvar

Frost resistance / Dona dayanım

Available / Var

Shade variation classification / Desen farklılaşması

V0

Product standard / Ürün standardı

EN14411 Group B1a:

Fullbody porcelain tiles / Fullbody porselen karolar

Dots

Dotti and Color Dot lines of PRO Function collection are specifically designed for the needs of high traffic areas.

Dots series with their tiny dotted design not only differentiate themselves for functional and yet sophisticated space designs but also provides an always-clean surface feel. Dotti and Color Dot lines offer extra resistance against abrasion with their full-body porcelain body and are available in 7 different colors and 6 different sizes.

Benekli dokusu ile yoğun trafik alan mekânlarda uzun süreli temizlik hissi veren Dotti ve Color Dot, şık ve küçük beneklerden oluştuğu için özellikle ticari ve kamu projelerinde tercih ediliyorlar. Fullbody porselen yapılarıyla her türlü aşınmaya karşı ekstra dayanıklılık sunan Dotti ve Color Dot ürün grubu karoları, 7 farklı renk seçeneğini 6 ayrı ebatla bir araya getiriyor.



Porcelain
Porselen



Floor tile
Yer karosu



Wall tile
Duvar karosu



Facade
Dış cephe



Pool surrounding
Havuz çevresi



Outdoors
Dış mekânlar



Industrial area
Endüstriyel alan



Commercial
Ticari alan



Frost resistance
Dona dayanım



Shade variation
Desen farklılaşması



Matt
Mat



Rectified
Rektifiyeli



Non-rectified
Rektifiyesiz



Modularity
Modülerlik



Garages and car
showrooms
Garajlar ve otomobil
galerileri

Function

Dots





Dotti ivory
Dotti fildişi



Dotti light beige
Dotti açık bej



Dotti light grey
Dotti açık gri

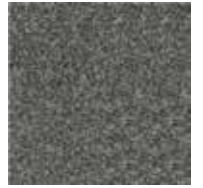

Dotti dark grey
Dotti koyu gri

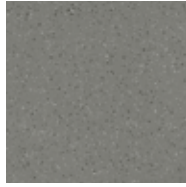

Color Dot grey
Color Dot gri



Color Dot dark mink
Color Dot koyu vizon

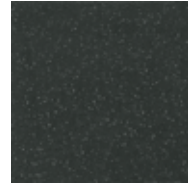

Color Dot anthracite
Color Dot antrasit

Function

Uni

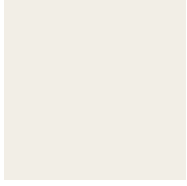

Super white
Süper beyaz

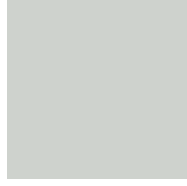

Silver
Gümüş

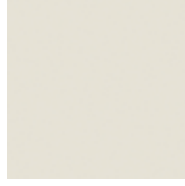

Ivory
Fildişi



Cement grey
Çimento gri



Grey
Gri



Dark mink
Koyu vizon



Black
Siyah

Color options overview

Renk seçeneklerine genel bakış

Dots



Dotti ivory
Dotti fildişi



Dotti light beige
Dotti açık bej



Dotti light grey
Dotti açık gri



Dotti dark grey
Dotti koyu gri

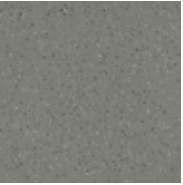

Color Dot grey
Color Dot gri



Color Dot dark mink
Color Dot koyu vizon

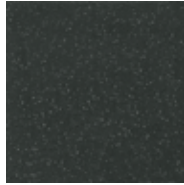

Color Dot anthracite
Color Dot antrasit

Function

Fullbody porcelain
Fullbody porselen



Porcelain
Porselen



Commercial
Ticari alan



Frost resistance
Dona dayanım



Matt
Mat



Non-rectified
Rektifiyesiz

■ M 5 x 5 cm / 2" x 2"
47 x 47 x 6 mm
EN14411 Bla

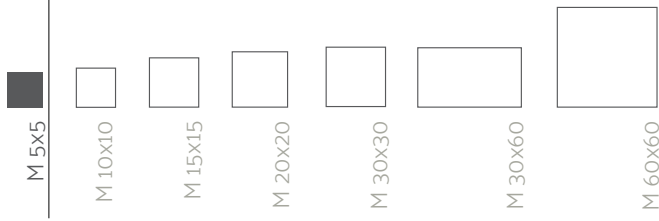

Uni

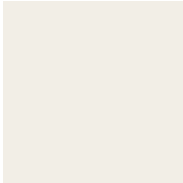

Super white / Süper beyaz
R10B
K50886480001VTEO

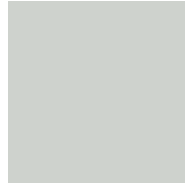

Silver / Gümüş
R10B
K51124680001VTEO

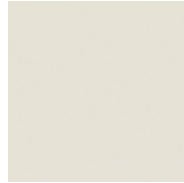

Ivory / Fildişi
R10B
K50568080001VTEO



Cement grey / Çimento gri
R10B
K52732580001VTEO



Grey / Gri
R10B
K50604180001VTEO



Black / Siyah
R10B
K50605280001VTEO



Dark mink / Koyu vizon
R10B
K94854780001VTEO

Dots



Dotti
Ivory / Fildişi
R10B
K50576180001VTEO



Dotti
Light beige / Açık bej
R10B
K50610080001VTEO



Dotti
Light grey / Açık gri
R10B
K50567680001VTEO

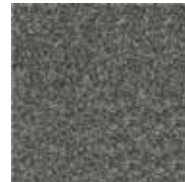

Dotti
Dark grey / Koyu gri
R10B
K50599380001VTEO



Color Dot
Grey / Gri
R10B
K51182180001VTEO



Color Dot
Dark mink / Koyu vizon
R10B
K52746580001VTEO

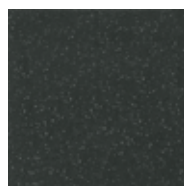

Color Dot
Anthracite / Antrasit
R10B
K50603080001VTEO



Porcelain
Porselen



Commercial
Ticari alan



Frost resistance
Dona dayanım



Matt
Mat



Non-rectified
Rektifiyesiz

Color options in size order Ebatlara göre renk dizilimi

■ M 10 x 10 cm / 4" x 4"
97 x 97 x 6 mm
EN14411 Bla

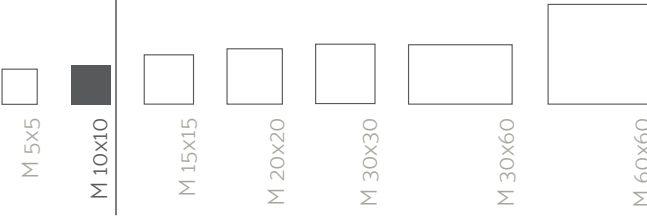

Uni

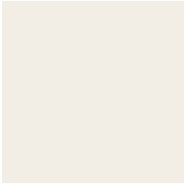

Super white / Süper beyaz
R10B
K50738280001VTE0

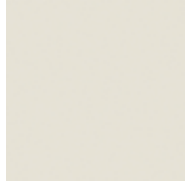

Ivory / Fildişi
R10B
K75744180001VTE0



Cement grey / Çimento gri
R10B
K52738480001VTE0



Grey / Gri
R10B
K75779180001VTE0

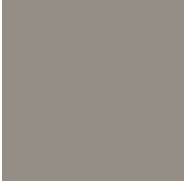

Dark mink / Koyu vizon
R10B
K53490080001VTE0



Black / Siyah
R10B
K76707180001VTE0

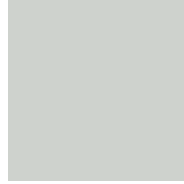

Silver / Gümüş
R10B
K51565080001VTE0

Dots



Dotti
Ivory / Fildişi
R10B
K52016380001VTE0



Dotti
Light grey / Açık gri
R10B
K52017480001VTE0

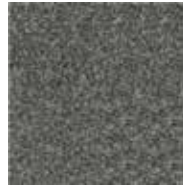

Dotti
Dark grey / Koyu gri
R10B
K52018580001VTE0



Dotti
Light beige / Açık bej
R10B
K94939780001VTE0



Color Dot
Grey / Gri
R10B
K51183280001VTE0



Color Dot
Dark mink / Koyu vizon
R10B
K52752480001VTE0

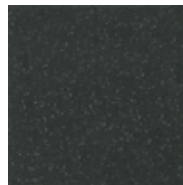

Color Dot
Anthracite / Antrasit
R10B
K76447080001VTE0

Function

Fullbody porcelain
Fullbody porselen



Porcelain
Porselen



Commercial
Ticari alan



Frost resistance
Dona dayanım



Matt
Mat



Non-rectified
Rektifiyesiz

■ M 15 x 15 cm / 6" x 6"
147 x 147 x 8 mm
EN14411 Bla



M 5x5



M 10x10



M 15x15



M 20x20



M 30x30



M 30x60



M 60x60

Uni

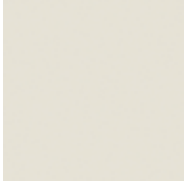

Ivory / Fildişi
R10B
K85060000001VTE0
R9
K83518400001VTE0

Dots



Dotti
Ivory / Fildişi
R9
K83515100001VTE0
R10B
K82376400001VTE0



Dotti
Light grey / Açık gri
R9
K83516200001VTE0
R10B
K82377500001VTE0

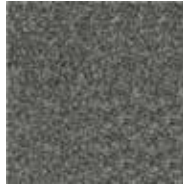

Dotti
Dark grey / Koyu gri
R9
K89604000001VTE0
R10B
K82378600001VTE0



Porcelain
Porselen



Commercial
Ticari alan



Frost resistance
Dona dayanım



Matt
Mat



Non-rectified
Rektifiyesiz

Color options in size order Ebatlara göre renk dizilimi

■ M 20 x 20 cm / 8" x 8"
197 x 197 x 8 mm
EN14411 Bla



Uni

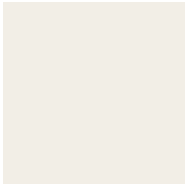

Super white / Süper beyaz
R9
K8355600001VTEO
R10A
K7767200001VTEO

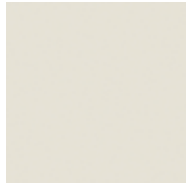

Ivory / Fildişi
R9
K83550100001VTEO
R10A
K75874400001VTEO
R10B
K83810200001VTEO



Cement grey / Çimento gri
R9
K85483100001VTEO
R10A
K90892500001VTEO

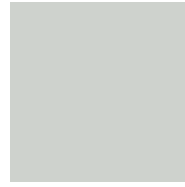

Silver / Gümüş
R9
K94941300001VTEO
R10A
K94993400001VTEO



Grey / Gri
R9
K83552300001VTEO
R10A
K8020600001VTEO



Black / Siyah
R9
K86003300001VTEO
R10A
K77291200001VTEO



Dark mink / Koyu vizon
R9
K94941400001VTEO
R10A
K94993500001VTEO

Dots



Dotti
Ivory / Fildişi
R9
K83532400001VTEO
R10A
K75674200001VTEO
R10B
K8237900001VTEO



Dotti
Light beige / Açık bej
R9
K83531300001VTEO
R10A
K78714200001VTEO



Dotti
Light grey / Açık gri
R9
K83533500001VTEO
R10A
K75445600001VTEO
R10B
K82380100001VTEO

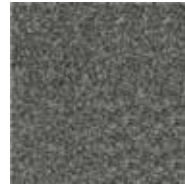

Dotti
Dark grey / Koyu gri
R9
K83534600001VTEO
R10A
K7544600001VTEO
R10B
K82381200001VTEO



Color Dot
Grey / Gri
R9
K83541600001VTEO
R10A
K80262500001VTEO



Color Dot
Dark mink / Koyu vizon
R9
K85493400001VTEO
R10A
K94993600001VTEO

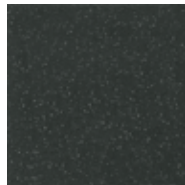

Color Dot
Anthracite / Antrasit
R9
K8354200001VTEO
R10A
K7670600001VTEO

Function

Fullbody porcelain
Fullbody porselen



Porcelain
Porselen



Commercial
Ticari alan



Frost resistance
Dona dayanım



Matt
Mat



Non-rectified
Rektifiyesiz

■ M 30 x 30 cm / 12" x 12"
297 x 297 x 8 mm
EN14411 Bla

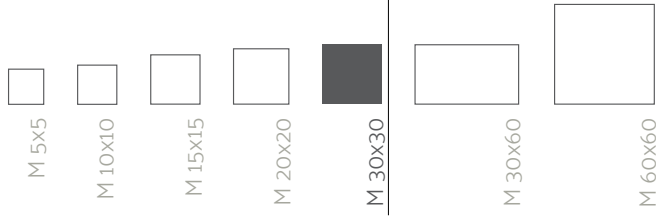

Uni

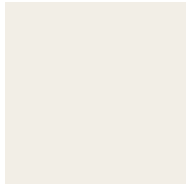

Super white /
Süper beyaz
R9
K83591000001VTE0
R10A
K77645100001VTE0

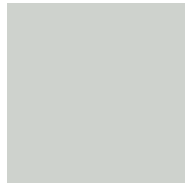

Silver / Gümüş
R9
K83583600001VTE0
R10A
K80516300001VTE0

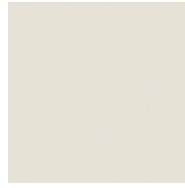

Ivory / Fildişi
R9
K83580300001VTE0
R10A
K75164500001VTE0
R10B
K83135600001VTE0



Cement grey /
Çimento gri
R9
K85485300001VTE0
R10A
K94993700001VTE0



Grey / Gri
R9
K83581400001VTE0
R10A
K75168200001VTE0



Dark mink / Koyu vizon
R9
K89245500001VTE0
R10A
K94993800001VTE0

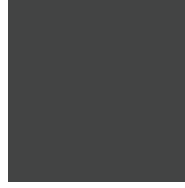

Black / Siyah
R9
K83584000001VTE0
R10A
K75170400001VTE0

Dots



Dotti
Ivory / Fildişi
R9
K83558200001VTE0
R10A
K75162300001VTE0
R10B
K82382300001VTE0



Dotti
Light beige / Açık bej
R9
K83562600001VTE0
R10A
K76566000001VTE0



Dotti
Light grey / Açık gri
R9
K83559300001VTE0
R10A
K75158600001VTE0
R10B
K82383400001VTE0

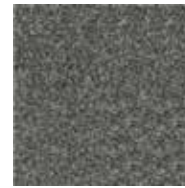

Dotti
Dark grey / Koyu gri
R9
K83560400001VTE0
R10A
K75160100001VTE0
R10B
K82384500001VTE0

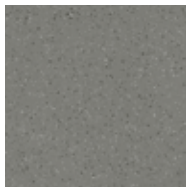

Color Dot
Grey / Gri
R9
K83570000001VTE0
R10A
K80263600001VTE0
R10B
K94965800001VTE0



Color Dot
Dark mink / Koyu vizon
R9
K85499300001VTE0
R10A
K86128200001VTE0

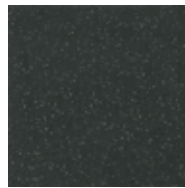

Color Dot
Anthracite / Antrasit
R9
K83571100001VTE0
R10A
K75799600001VTE0



Porcelain
Porselen



Commercial
Ticari alan



Frost resistance
Dona dayanım



Matt
Mat



Non-rectified
Rektifiyesiz

Color options in size order
Ebatlara göre renk dizilimi

■ M 30 x 60cm / 12" x 24"
297 x 597 x 9 mm
EN14411 Bla



M 5x5



M 10x10



M 15x15



M 20x20



M 30x30



M 30x60



M 60x60

Uni



Ivory / Fildişi
R9
K76698600001VTE0

Dots



Dotti
Ivory / Fildişi
R9
K76614600001VTE0



Dotti
Light grey / Açık gri
R9
K76612400001VTE0
R10B
K94705400001VTE0



Dotti
Dark grey / Koyu gri
R9
K76825200001VTE0
R10B
K94705300001VTE0

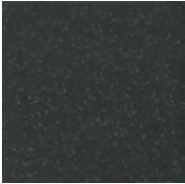

Color Dot
Anthracite / Antrasit
R10B
K95007900001VTE0

Function

Fullbody porcelain
Fullbody porselen



Porcelain
Porselen



Commercial
Ticari alan



Frost resistance
Dona dayanım



Matt
Mat



Rectified
Rektifiyeli

■ M 60 x 60 cm / 24" x 24"
597 x 597 x 9 mm
EN14411 Bla

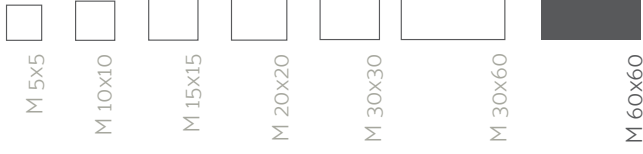

Uni

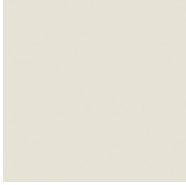

Ivory / Fildişi
R9
K768704R0001VTE0

Dots



Dotti
Ivory / Fildişi
R9
K768542R0001VTE0*



Dotti
Light grey / Açık gri
R9
K768505R0001VTE0*



Dotti
Dark grey / Koyu gri
R9
K949436R0001VTE0*

*1987 m² MOQ is applied to 60x60 Uni and Dotti 9 mm and 14 mm products.

*60x60 Uni ve Dotti 9 mm ve 14 mm ürünlerine 1987 m² MOQ uygulanmaktadır.



Floor tiles / Yer karoları : K83562600001VTE0 30x30 Function Dotti Light beige / Açık bej R9
K85499300001VTE0 30x30 Function Color Dot Dark mink / Koyu vizon R9

Function

Fullbody porcelain
Fullbody porselen

Uni

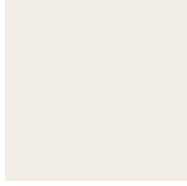

Super white
Süper beyaz

5x5
K50886480001VTEo R10B
10x10
K50738280001VTEo R10B
20x20
K83556000001VTEo R9
20x20
K77672000001VTEo R10A
30x30
K83591000001VTEo R9
30x30
K77645100001VTEo R10A

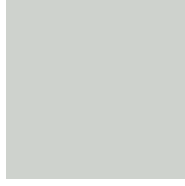

Silver
Gümüş

5x5
K51124680001VTEo R10B
10x10
K51565080001VTEo R10B
20x20
K94941300001VTEo R9
20x20
K94993400001VTEo R10A
30x30
K83583600001VTEo R9
30x30
K80516300001VTEo R10A

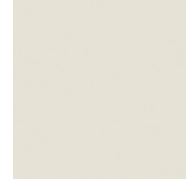

Ivory
Fildişi

5x5
K50568080001VTEo R10B
10x10
K75744180001VTEo R10B
15x15
K83518400001VTEo R9
15x15
K85060000001VTEo R10B
20x20
K83550100001VTEo R9
20x20
K75874400001VTEo R10A
20x20
K83810200001VTEo R10B
30x30
K83580300001VTEo R9
30x30
K75164500001VTEo R10A
30x30
K83135600001VTEo R10B
30x60
K76698600001VTEo R9
60x60
K768704R0001VTEo R9



Cement grey
Çimento gri

5x5
K52732580001VTEo R10B
10x10
K52738480001VTEo R10B
20x20
K85483100001VTEo R9
20x20
K90892500001VTEo R10A
30x30
K85485300001VTEo R9
30x30
K94993700001VTEo R10A



Grey
Gri

5x5
K50604180001VTEo R10B
10x10
K75779180001VTEo R10B
20x20
K83552300001VTEo R9
20x20
K80200600001VTEo R10A
30x30
K83581400001VTEo R9
30x30
K75168200001VTEo R10A



Dark mink
Koyu vizon

5x5
K94854780001VTEo R10B
10x10
K53490080001VTEo R10B
20x20
K94941400001VTEo R9
20x20
K94993500001VTEo R10A
30x30
K89245500001VTEo R9
30x30
K94993800001VTEo R10A



Black
Siyah

5x5
K50605280001VTEo R10B
10x10
K76707180001VTEo R10B
20x20
K86003300001VTEo R9
20x20
K77291200001VTEo R10A
30x30
K83584000001VTEo R9
30x30
K75170400001VTEo R10A

Size options in color order Renklere göre ebat dizilimi

Dots



Dotti
Ivory / Fildişi

5x5
K50576180001VTEo R10B
10x10
K52016380001VTEo R10B
15x15
K83515100001VTEo R9
15x15
K82376400001VTEo R10B
20x20
K83532400001VTEo R9
20x20
K75674200001VTEo R10A
20x20
K82379000001VTEo R10B
30x30
K83558200001VTEo R9
30x30
K75162300001VTEo R10A
30x30
K82382300001VTEo R10B
30x60
K76614600001VTEo R9
60x60
K768542R0001VTEo



Dotti
Light beige / Açık bej

5x5
K50610080001VTEo R10B
10x10
K94939780001VTEo R10B
20x20
K83531300001VTEo R9
20x20
K78714200001VTEo R10A
30x30
K83562600001VTEo R9
30x30
K76566000001VTEo R10A



Dotti
Light grey / Açık gri

5x5
K50567680001VTEo R10B
10x10
K52017480001VTEo R10B
15x15
K83516200001VTEo R9
15x15
K82377500001VTEo R10B
20x20
K8353500001VTEo R9
20x20
K75445600001VTEo R10A
20x20
K82380100001VTEo R10B
30x30
K83559300001VTEo R9
30x30
K75158600001VTEo R10A
30x30
K82383400001VTEo R10B
30x60
K94705400001VTEo R10B
30x60
K76612400001VTEo R9
60x60
K768505R0001VTEo R9

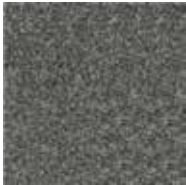

Dotti
Dark grey / Koyu gri

5x5
K50599380001VTEo R10B
10x10
K52018580001VTEo R10B
15x15
K89604000001VTEo R9
15x15
K82378600001VTEo R10B
20x20
K83534600001VTEo R9
20x20
K75446000001VTEo R10A
20x20
K82381200001VTEo R10B
30x30
K83560400001VTEo R9
30x30
K75160100001VTEo R10A
30x30
K82384500001VTEo R10B
30x60
K94705300001VTEo R10B
30x60
K76825200001VTEo R9
60x60
K949436R0001VTEo R9

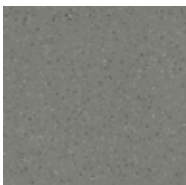

Color Dot
Grey / Gri

5x5
K51182180001VTEo R10B
10x10
K51183280001VTEo R10B
20x20
K83541600001VTEo R9
20x20
K80262500001VTEo R10A
30x30
K83570000001VTEo R9
30x30
K80263600001VTEo R10A



Color Dot
Dark mink / Koyu vizon

5x5
K52746580001VTEo R10B
10x10
K52752480001VTEo R10B
20x20
K85493400001VTEo R9
20x20
K94993600001VTEo R10A
30x30
K86128200001VTEo R10A
30x30
K85499300001VTEo R9

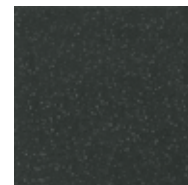

Color Dot
Anthracite / Antrasit

5x5
K50603080001VTEo R10B
10x10
K76447080001VTEo R10B
20x20
K83542000001VTEo R9
20x20
K76706000001VTEo R10A
30x30
K83571100001VTEo R9
30x30
K75799600001VTEo R10A
30x60
K95007900001VTEo R10B

Function

Special surfaces & thickness
Özel yüzeyler & kalınlık



PRO

Technic

Porcelain tiles / Porselen karolar

Body type / Bünye tipi

Fullbody porcelain / Fullbody porselen

Surface alternatives / Yüzey alternatifleri

R10A

R10B

Mercato - R11B

Corund - R11B

Diamond - R12 V4

Base tile sizes / Fon ebatları

M15x15 cm (147x147x8 mm)

M20x20 cm (197x197x8 mm)

M20x20 cm (197x197x12 mm)

M20x20 cm (197x197x14 mm)

M30x30 cm (297x297x8 mm)

M30x30 cm (297x297x12 mm)

M60x60 cm (597x597x9 mm)

M60x60 cm (597x597x14 mm)

Base tile colors / Fon renkleri

Uni ivory / Uni fildişi

Dotti ivory / Dotti fildişi

Dotti light grey / Dotti açık gri

Dotti dark grey / Dotti koyu gri

Color Dot anthracite / Color Dot antrasit

Usage areas / Kullanım alanları

Commercial area / Ticari alan

Industrial area / Endüstriyel alan

Tiling areas / Döşeme alanları

Floor / Yer

Frost resistance / Dona dayanım

Available / Var

Shade variation classification /

Desen Farklılaşması

Vo

Product standard / Ürün standardı

EN14411 Group B1a:

Fullbody porcelain tiles / Fullbody porselen karolar

Special surfaces & thickness

Technic porcelain tiles with special surfaces designed for industrial areas

PRO Function special surfaces are offered as a special product group which guarantees effective anti-slip protection with different anti-slip classes in industrial areas, under heavy traffic and excessive load. Function special surfaces offer an opportunity to create safe walking and working environment with easy to clean surfaces and are ideal for factories, slaughterhouses, milk and dairy plants, industrial kitchens and for all other sites where special industrial footwear are worn. Function special surfaces are manufactured in industrial anti-slip classes from R10 to R12, in different sizes with 3 special surface alternatives in Uni and Dots textures.

Özel yüzeyler & kalınlık

Endüstriyel alanlar için tasarlanmış
Özel yüzeyli teknik porselen karolar

PRO Function özel yüzeyleri, yoğun trafik ve aşırı yük altında, Endüstriyel alanlarda farklı kaymazlık ve kalınlık dereceleri ile kaymaya karşı etkin koruma sağlayan özel bir ürün grubu olarak sunuluyor. Güvenli dolaşım ve çalışma ortamları yaratma olanağı sunan Function, kolay temizlenme avantajıyla fabrika, kesimhane, süt ve süt ürünleri, endüstriyel mutfaklar, işçi ayakkabısı ya da botu kullanılan bütün mekânlar için ideal bir üründür. Function özel yüzeyleri, Uni ve Dotti ürün grubu özelliklerini içeren 3 özel yüzey alternatifleriyle R10'dan R12'ye kadar endüstriyel zemin kaymazlığı sınıflarında üretiyor.



Porcelain
Porselen



Floor tile
Yer karosu



Façade
Dış cephe



Commercial
Ticari alan



Pool surrounding
Havuz çevresi



Outdoors
Dış mekânlar



Industrial area
Endüstriyel alan



Frost resistance
Dona dayanım



Shade variation
Desen farklılaşması



Matt
Mat



Garages and car
showrooms
Garajlar ve otomobil
galerileri

Function

Special surfaces & thickness
Özel yüzeyler & kalınlık

PRO Function's special surfaces with different reliefs are designed to provide special anti-slip needs of technical surfaces.

PRO Function koleksiyonundaki özel yüzeyli karolar, özel rölyefler kullanılarak döşeme yerlerine ve amaçlarına göre ihtiyaç duyulan kaydırmazlık sınıfını sağlayacak şekilde tasarlanmıştır.

R10A / R10B

Mercato
R11B

Corund
R11B

Diamond
R12V4

Uni

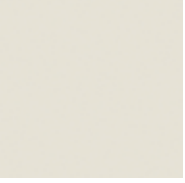

Ivory
Fildişi

Dots



Dotti ivory
Dotti fildişi



Dotti light grey
Dotti açık gri

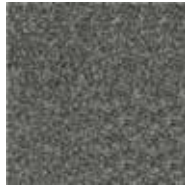



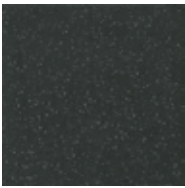











Dotti dark grey
Dotti koyu gri



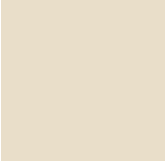
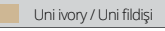
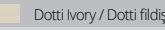
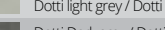
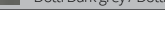
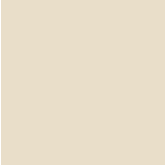

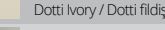
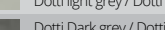
Color Dot anthracite
Color Dot antrasit

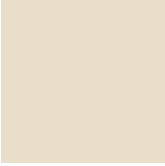
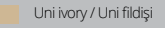
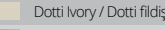
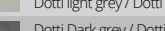
Function

Special surfaces & thickness Özel yüzeyler & kalınlık

									
	M 15 x 15 cm 6" x 6" 147 x 147 x 8 mm	M 20 x 20 cm 8" x 8" 197 x 197 x 8 mm	M 20 x 20 cm 8" x 8" 197 x 197 x 12 mm	M 20 x 20 cm 8" x 8" 197 x 197 x 14 mm	M 30 x 30 cm 12" x 12" 297 x 297 x 8 mm	M 30 x 30 cm 12" x 12" 297 x 297 x 12 mm	M 30 x 60 cm 12" x 24" 297 x 597 x 9 mm	M 60 x 60 cm 24" x 24" 597 x 597 x 9 mm	M 60 x 60 cm 24" x 24" 597 x 597 x 14 mm
									
R9									
Uni									
	K83518400001VTE0	K83550100001VTE0			K83580300001VTE0		K76698600001VTE0	K768704R0001VTE0*	
Dots									
	K83515100001VTE0	K83532400001VTE0			K83558200001VTE0		K76614600001VTE0	K768542R0001VTE0*	
	K83516200001VTE0	K83533500001VTE0			K83559300001VTE0		K76612400001VTE0	K768505R0001VTE0*	
	K89604000001VTE0	K83534600001VTE0			K83560400001VTE0		K76825200001VTE0	K949436R0001VTE0*	
									
R10A									
Uni									
		K75874400001VTE0	K75865200001VTE0	K76170300001VTE0	K75164500001VTE0	K82516400001VTE0			K949437R0001VTE0*
Dots									
		K75674200001VTE0	K75780100001VTE0	K76116500001VTE0	K75162300001VTE0	K82513100001VTE0			K949438R0001VTE0*
		K75445600001VTE0	K86415200001VTE0	K76117600001VTE0	K75158600001VTE0	K82514200001VTE0			K949439R0001VTE0*
		K75446600001VTE0	K86416300001VTE0	K76169200001VTE0	K75160100001VTE0	K82515300001VTE0			K949440R0001VTE0*
									
R10B									
Uni									
	K85060000001VTE0	K83810200001VTE0			K83135600001VTE0				
Dots									
	K82376400001VTE0	K82379000001VTE0			K82382300001VTE0				
	K82377500001VTE0	K82380100001VTE0			K82383400001VTE0				
	K82378600001VTE0	K82381200001VTE0			K82384500001VTE0				

Color options in size order Ebatlara göre renk dizilimi

									
	M 15 x 15 cm 6" x 6" 147 x 147 x 8 mm	M 20 x 20 cm 8" x 8" 197 x 197 x 8 mm	M 20 x 20 cm 8" x 8" 197 x 197 x 12 mm	M 20 x 20 cm 8" x 8" 197 x 197 x 14 mm	M 30 x 30 cm 12" x 12" 297 x 297 x 8 mm	M 30 x 30 cm 12" x 12" 297 x 297 x 12 mm	M 30 x 60 cm 12" x 24" 297 x 597 x 9 mm	M 60 x 60 cm 24" x 24" 597 x 597 x 9 mm	M 60 x 60 cm 24" x 24" 592 x 592 x 14 mm
									
Mercato R11B Uni									
Uni Ivory / Uni fildişi	K94940700001VTE0	K94941800001VTE0	K78531000001VTE0	K76168100001VTE0	K79122400001VTE0	K94943000001VTE0			
Dots									
Dotti Ivory / Dotti fildişi	K94940800001VTE0	K78140600001VTE0	K78143200001VTE0	K76165500001VTE0	K78146600001VTE0	K94943200001VTE0			
Dotti light grey / Dotti açık gri	K82393000001VTE0	K78138400001VTE0	K78141000001VTE0	K76166600001VTE0	K78144300001VTE0	K89711200001VTE0			
Dotti Dark grey / Dotti koyu gri	K78965100001VTE0	K78139500001VTE0	K78142100001VTE0	K76167000001VTE0	K78145400001VTE0	K84468200001VTE0			
									
Corund R11B Uni									
Uni Ivory / Uni fildişi	K75814000001VTE0	K75811400001VTE0	K75867400001VTE0		K79118000001VTE0				
Dots									
Dotti Ivory / Dotti fildişi	K75786000001VTE0	K75791600001VTE0	K75873300001VTE0		K79112100001VTE0				
Dotti light grey / Dotti açık gri	K75784500001VTE0	K75789400001VTE0	K75869600001VTE0		K79110600001VTE0				
Dotti Dark grey / Dotti koyu gri	K79360400001VTE0	K75790500001VTE0	K75871100001VTE0		K79111000001VTE0				
									
Diamond R12V4 Uni									
Uni Ivory / Uni fildişi	K75813600001VTE0	K75809200001VTE0	K75866300001VTE0						
Dots									
Dotti Ivory / Dotti fildişi	K75783400001VTE0	K75794200001VTE0	K75872200001VTE0						
Dotti light grey / Dotti açık gri	K75781200001VTE0	K75792000001VTE0	K75868500001VTE0						
Dotti Dark grey / Dotti koyu gri	K85710400001VTE0	K75793100001VTE0	K75870000001VTE0						
Color Dot anthracite / Color Dot antrasit			K87748500001VTE0						

Please find detailed information about industrial and barefoot slip resistance and recommended usage areas on the related technical information page.

Endüstriyel ve çıplak ayak kayma dirençleriyle ilgili detaylı bilgiyi ve önerilen kullanım alanlarını ilgili teknik bilgiler sayfasında bulabilirsiniz.

*1987 m² MOQ is applied to 60x60 Uni and Dotti 9 mm and 14 mm products.

*60x60 Uni ve Dotti 9 mm ve 14 mm ürünlerine 1987 m² MOQ uygulanmaktadır.

Function

Complementary pieces
Tamamlayıcı parçalar



PRO

Technic

Porcelain tiles / Porselen karolar

Body type / Bnye tipi

Fullbody porcelain / Fullbody porselen

Surface alternatives / Yzey alternatifleri

Matt / Mat

Base tile colors / Fon renkleri

Uni fildii / Uni ivory

Uni gri / Uni grey

Uni siyah / Uni black

Doltti fildii / Dotti ivory

Dotti aık gri / Dotti light grey

Dotti koyu gri / Dotti dark grey

Usage areas / Kullanım alanları

Commercial area / Ticari alan

Industrial area / Endstriyel alan

Tiling areas / Deme alanları

Floor / Yer

Wall / Duvar

Frost resistance / Dona dayanım

Available / Var

Shade variation classification /

Desen farklılaşması

VO

Product standard / rn standardı

EN14411 Group B1a:

Fullbody porcelain tiles / Fullbody porselen karolar

Complementary pieces

Integrated solutions

Function complementary pieces provide covering solutions in 6 colors for all types of edges and corners. The parts that ensure aesthetic appearance and ease of cleaning and are very suitable for all kinds of wet industrial spaces and for daily use as well. Moreover, thanks to their modular structure, they can be used with all products available in PRO Color and PRO Function ranges.

Tamamlayıcı paralar

Btnsel czmler

Function 6 renkte kenar ve ke dnleri iin kaplama czmleri sunar. Estetiđin yanı sıra temizlik imknı da sađlayan paralar; her trden ıslak ve endstriyel meknın yanı sıra, gnlk kullanım iin de son derece uygun. stelik, modler yapıları sayesinde Function ve Color rnleriyle birlikte kullanılabilir.



Porcelain
Porselen



Floor tile
Yer karosu



Wall tile
Duvar karosu



Commercial
Ticari alan



Pool surrounding
Havuz cvresi



Outdoors
Dı meknlar



Industrial area
Endstriyel alan



Frost resistance
Dona dayanım







Shade variation
Desen farklılaşması











Matt
Mat

Function

Complementary pieces
Tamamlayıcı parçalar



Colors / Renkler	Right angled sit-in set / Köşeli dönüş parçaları sit-in				
	2x20	3x10	2x10	10x10	10x20
	Internal-external beading sit-in	Covebase external corner sit-in	Covebase internal corner sit-in	Covebase sit-in	Covebase sit-in
	İç-diş profil sit-in	Diş köşe dönüş parçası sit-in	İç köşe dönüş parçası sit-in	Kenar dönüş parçası sit-in	Kenar dönüş parçası sit-in
	6 mm	6 mm	6 mm	6 mm	6 mm
					
Uni ivory / Uni fildişi	K94949300001VTE0	K82045100001VTE0	K82022600001VTE0	K79141200001VTE0	K94948700001VTE0
Uni grey / Uni gri	K94949700001VTE0	K83511400001VTE0	K83512500001VTE0	K94948500001VTE0	K94949100001VTE0
Uni black / Uni siyah	K94949800001VTE0	K87657500001VTE0	K87656400001VTE0	K94948600001VTE0	K94949200001VTE0
Dotti ivory / Dotti fildişi	K94949400001VTE0	K82047300001VTE0	K82024100001VTE0	K79131600001VTE0	K94948800001VTE0
Dotti light grey / Dotti açık gri	K94949500001VTE0	K82053200001VTE0	K82030000001VTE0	K78997500001VTE0	K94948900001VTE0
Dotti dark grey / Dotti koyu gri	K94949600001VTE0	K82054300001VTE0	K82031100001VTE0	K79138600001VTE0	K94949000001VTE0



Colors / Renkler	Right angled sit-in set / Köşeli dönüş parçaları sit-in			
	3x10	2x10	10x15	10x20
	Covebase external corner sit-in	Covebase internal corner sit-in	Covebase sit-in	Covebase sit-in
	Diş köşe dönüş parçası sit-in	İç köşe dönüş parçası sit-in	Kenar dönüş parçası sit-in	Kenar dönüş parçası sit-in
	8 mm	8 mm	8 mm	8 mm
				
Uni ivory / Uni fildişi	K76299600001VTE0	K76298500001VTE0	-	K76288200001VTE0
Uni grey / Uni gri	K76295200001VTE0	K76292600001VTE0	K76289300001VTE0	K76285600001VTE0
Uni black / Uni siyah	K76931100001VTE0	K76936600001VTE0	-	K78713000001VTE0
Dotti ivory / Dotti fildişi	K76296300001VTE0	K76293000001VTE0	K76290400001VTE0	K76286000001VTE0
Dotti light grey / Dotti açık gri	K76297400001VTE0	K76294100001VTE0	K79362600001VTE0	K76287100001VTE0
Dotti dark grey / Dotti koyu gri	K76939200001VTE0	K76941400001VTE0	-	K78477200001VTE0

Colors / Renkler	Round angled sit-on set / Dairesel dönüş parçaları sit-on			
	3x20	10x20	3x10	3x10
	Internal-external beading sit-on	Covebase sit-on	Covebase external corner sit-on	Covebase internal corner sit-on
	İç-dış profil sit-on	Kenar dönüş parçası sit-on	Dış köşe dönüş parçası sit-on	İç köşe dönüş parçası sit-on
	8 mm	8 mm	8 mm	8 mm
				
Uni ivory / Uni fildişi	K86801300001VTE0	K77037200001VTE0	K77045300001VTE0	K77041600001VTE0
Uni grey / Uni gri	K86909600001VTE0	K86083600001VTE0	K94947300001VTE0	K94947100001VTE0
Uni black / Uni siyah	K94950200001VTE0	K91237000001VTE0	K84712100001VTE0	K94947200001VTE0
Dotti ivory / Dotti fildişi	K94949900001VTE0	K77036100001VTE0	K77044200001VTE0	K77040500001VTE0
Dotti light grey / Dotti açık gri	K94950000001VTE0	K77038300001VTE0	K77046400001VTE0	K77042000001VTE0
Dotti dark grey / Dotti koyu gri	K94950100001VTE0	K77039400001VTE0	K77047500001VTE0	K77043100001VTE0

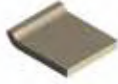
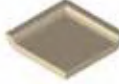
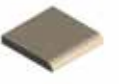
Function

Complementary pieces Tamamlayıcı parçalar

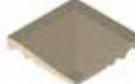
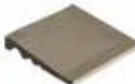
Colors / Renkler	Covebase bullnose set / Kenar dönüş ve yuvarlak kenarlı bitiş parçaları			
	5x5	5x5	5x5	5x5
	Covebase	Covebase internal corner	Bullnose	Bullnose corner
	Kenar dönüş parçası	Çift kenar dönüş parçası	Bullnose	Bullnose köşe
	6 mm	6 mm	6 mm	6 mm
				
Uni ivory / Uni fildişi	K86191230001VTE0	K86199300001VTE0	K80343270001VTE0	K80345400001VTE0
Uni grey / Uni gri	K86624130001VTE0	K94950500001VTE0	K80362070001VTE0	K80364200001VTE0
Uni black / Uni siyah	K94950930001VTE0	K94950600001VTE0	K80352470001VTE0	K80354600001VTE0
Dotti ivory / Dotti fildişi	K86192330001VTE0	K86200400001VTE0	K51299070001VTE0	K51314100001VTE0
Dotti light grey / Dotti açık gri	K94950730001VTE0	K94950300001VTE0	K80408470001VTE0	K51316300001VTE0
Dotti dark grey / Dotti koyu gri	K94950830001VTE0	K94950400001VTE0	K51300170001VTE0	K51315200001VTE0

Colors / Renkler	Shower inclined edge / Duş parçaları			Plinth / Süpürgelik	Step tread / Basamak
	10x10	10x10	2x10	7x30	30x30
	Shower inclined end edge	Shower inclined end edge internal	Shower inclined end edge external	Plinth	Tread
	Duş parçası	Duş parçası iç köşe	Duş parçası dış köşe	Süpürgelik	Basamak
	6/14 mm	6/14 mm	6/14 mm	8 mm	8 mm
					
Uni ivory / Uni fildişi	K78607600001VTE0	K78608000001VTE0	K83701500001VTE0	K75230100001VTE0	K75468100001VTE0
Uni grey / Uni gri	K80457300001VTE0	K88203500001VTE0	K84162400001VTE0	K75231200001VTE0	K75469200001VTE0
Uni black / Uni siyah	K88672600001VTE0	K88673000001VTE0	K94951100001VTE0	K75232300001VTE0	K75470300001VTE0
Dotti ivory / Dotti fildişi	K86096500001VTE0	K86097600001VTE0	K86098000001VTE0	K75233400001VTE0	K75462200001VTE0
Dotti light grey / Dotti açık gri	K86099100001VTE0	K86100200001VTE0	K86101300001VTE0	K75234500001VTE0	K75463300001VTE0
Dotti dark grey / Dotti koyu gri	K86102400001VTE0	K86103500001VTE0	K86104600001VTE0	K75235600001VTE0	K75464400001VTE0
Color Dot anthracite / Color Dot antrasit	-	-	-	K75864100001VTE0	K75862600001VTE0

Right angled sit-in set 8mm
Köşeli dönüş parçaları sit-in 8mm

Complementary pieces
Tamamlayıcı parçalar

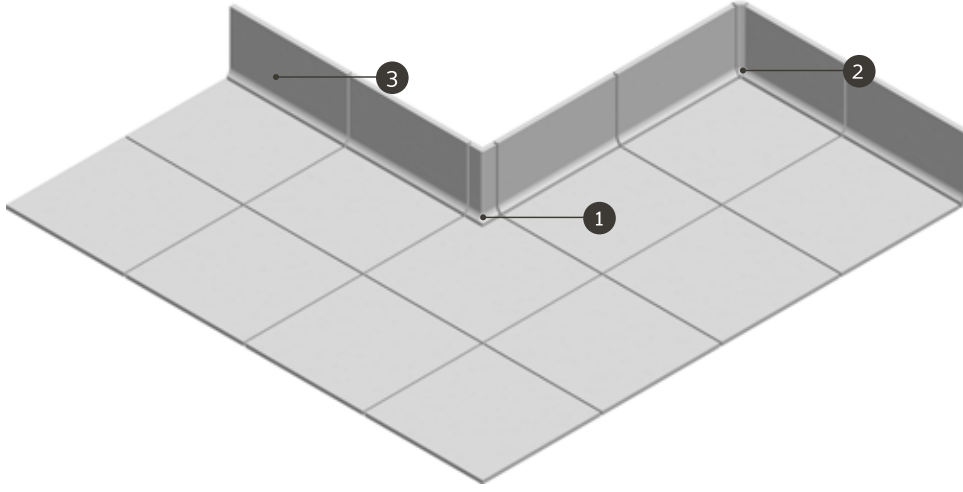

1 Covebase external corner sit-in
Dış köşe dönüş parçası sit-in

2 Covebase internal corner sit-in
İç köşe dönüş parçası sit-in

3 Covebase sit-in
Kenar dönüş parçası sit-in

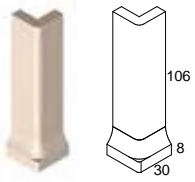

Covebase external corner sit-in

Dış köşe dönüş parçası sit-in

M 3 x 10 cm / 1"x 4"

8mm

Uni

Uni ivory
Uni fildişi
K76299600001VTE0

Dots

Dotti ivory
Dotti fildişi
K76295200001VTE0

Dotti light beige
Dotti açık bej
K76931100001VTE0

Dotti light grey
Dotti açık gri
K76296300001VTE0

Dotti dark grey
Dotti koyu gri
K76297400001VTE0

Color Dot anthracite
Color Dot antrasit
K76939200001VTE0

Function

Right angled sit-in set 8mm
Köşeli dönüş parçaları sit-in 8mm

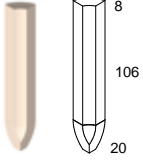

Covebase internal corner sit-in

İç köşe dönüş parçası sit-in

M 2 x 10 cm / 1"x 4"

8mm

Uni



Uni ivory
Uni fildişi
K76298500001VTE0

Dots



Dotti ivory
Dotti fildişi
K76292600001VTE0



Dotti dark grey
Dotti koyu gri
K76294100001VTE0



Dotti light beige
Dotti açık bej
K76936600001VTE0



Color Dot anthracite
Color Dot antrasit
K76941400001VTE0



Dotti light grey
Dotti açık gri
K76293000001VTE0

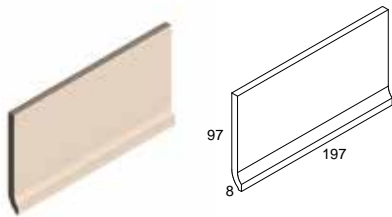

Covebase sit-in

Kenar dönüş parçası sit-in

M 10 x 20 cm / 4"x 8"

8mm

Uni



Uni ivory
Uni fildişi
K76288200001VTE0

Dots



Dotti ivory
Dotti fildişi
K76285600001VTE0



Dotti dark grey
Dotti koyu gri
K76287100001VTE0



Dotti light beige
Dotti açık bej
K78713000001VTE0



Color Dot anthracite
Color Dot antrasit
K78477200001VTE0



Dotti light grey
Dotti açık gri
K76286000001VTE0

Complementary pieces Tamamlayıcı parçalar



Covebase sit-in
Kenar dönüş parçası sit-in
M 10 x 15 cm / 4"x 6"
8mm

Dots



Dotti ivory
Dotti fildişi
K76289300001VTE0



Dotti light grey
Dotti açık gri
K76290400001VTE0



Dotti dark grey
Dotti koyu gri
K79362600001VTE0

Function

Right angled sit-in set 6mm
Köşeli dönüş parçaları sit-in 6mm

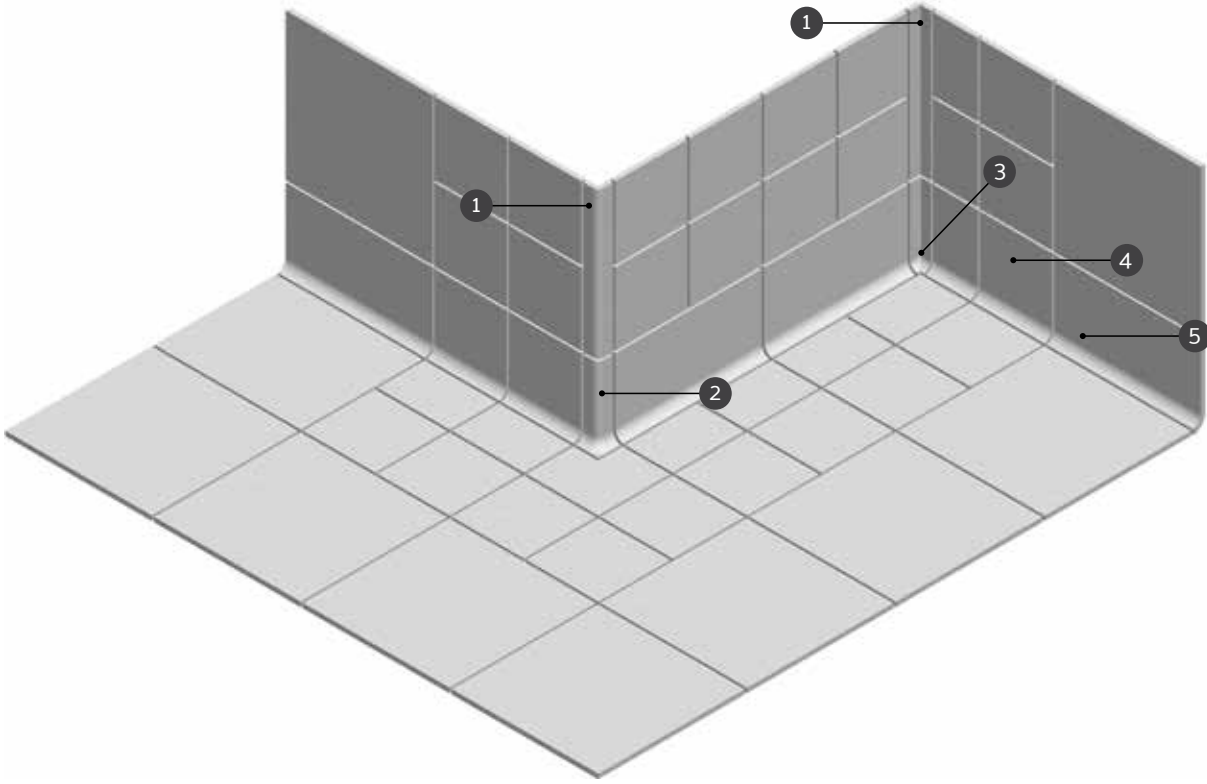

1 Internal - external beading sit-in
İç dış profil sit-in

2 Covebase external corner sit-in
Dış köşe dönüş parçası sit-in

3 Covebase internal corner sit-in
İç köşe dönüş parçası sit-in

4 Covebase sit-in
Kenar dönüş parçası sit-in

5 Covebase sit-in
Kenar dönüş parçası sit-in

Complementary pieces Tamamlayıcı parçalar

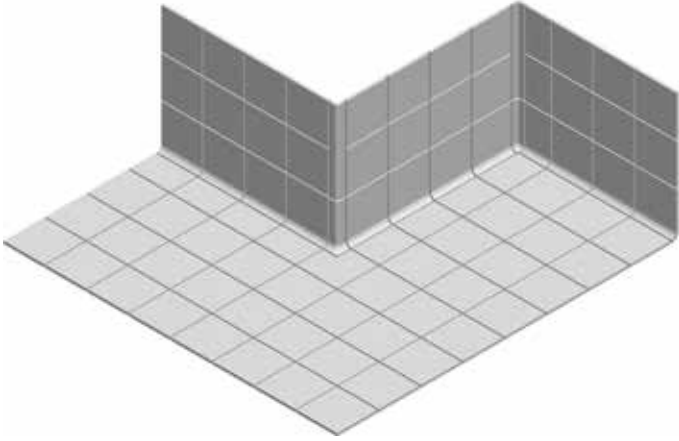

M10x10 Right angled sit-in set 6mm modularity
M10x10 Köşeli dönüş parçaları sit-in 6mm modülasyonu

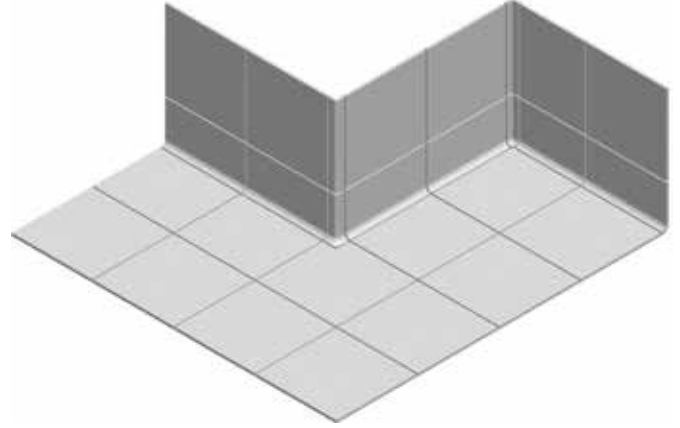

M20x20 Right angled sit-in set 6mm modularity
M20x20 Köşeli dönüş parçaları sit-in 6mm modülasyonu

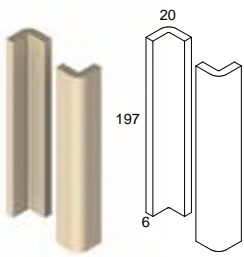

Internal - external beading sit-in

İç dış profil sit-in
M 2 x 20 cm / 1"x 8"
6mm
IDP220

Uni

Uni ivory
Uni fildişi
K94949300001VTE0

Uni grey
Uni gri
K94949700001VTE0

Uni black
Uni siyah
K94949800001VTE0

Dots

Dotti ivory
Dotti fildişi
K94949400001VTE0

Dotti light grey
Dotti açık gri
K94949500001VTE0

Dotti dark grey
Dotti koyu gri
K94949600001VTE0

Function

Right angled sit-in set 6mm
Köşeli dönüş parçaları sit-in 6mm

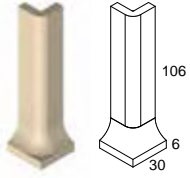

Covebase external corner sit-in

Dış köşe dönüş parçası sit-in

M 3 x 10 cm / 1"x 4"

6mm

DKI310

Uni



Uni ivory
Uni fildişi
K82045100001VTE0



Uni grey
Uni gri
K83511400001VTE0



Uni black
Uni siyah
K87657500001VTE0

Dots



Dotti ivory
Dotti fildişi
K82047300001VTE0



Dotti light grey
Dotti açık gri
K82053200001VTE0



Dotti dark grey
Dotti koyu gri
K82054300001VTE0

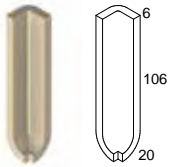

Covebase internal corner sit-in

İç köşe dönüş parçası sit-in

M 2 x 10 cm / 1"x 4"

6mm

IK210

Uni



Uni ivory
Uni fildişi
K82022600001VTE0



Uni grey
Uni gri
K83512500001VTE0



Uni black
Uni siyah
K87656400001VTE0

Dots



Dotti ivory
Dotti fildişi
K82024100001VTE0



Dotti light grey
Dotti açık gri
K82030000001VTE0



Dotti dark grey
Dotti koyu gri
K82031100001VTE0

Complementary pieces Tamamlayıcı parçalar

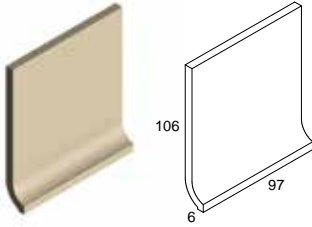

Covebase sit-in
Kenar dönüş parçası sit-in
M 10 x 10 cm / 4"x 4"
6mm
KDI1010

Uni

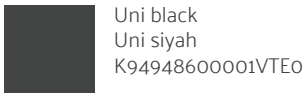
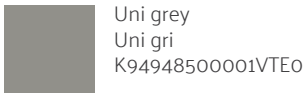
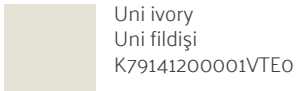

Dots

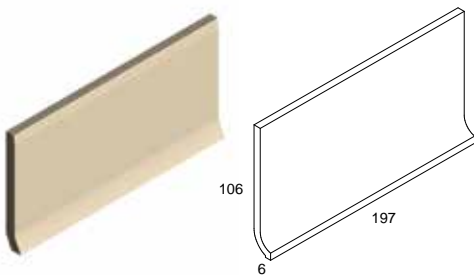
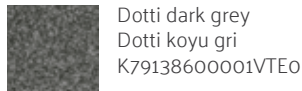
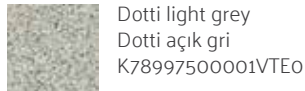
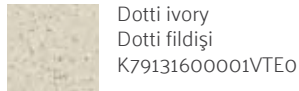

Covebase sit-in
Kenar dönüş parçası sit-in
M 10 x 20 cm / 4"x 8"
6mm
KDI1020

Uni

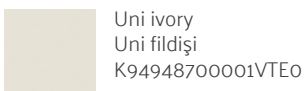

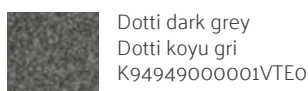
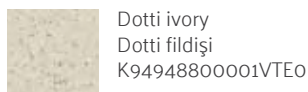

Dots



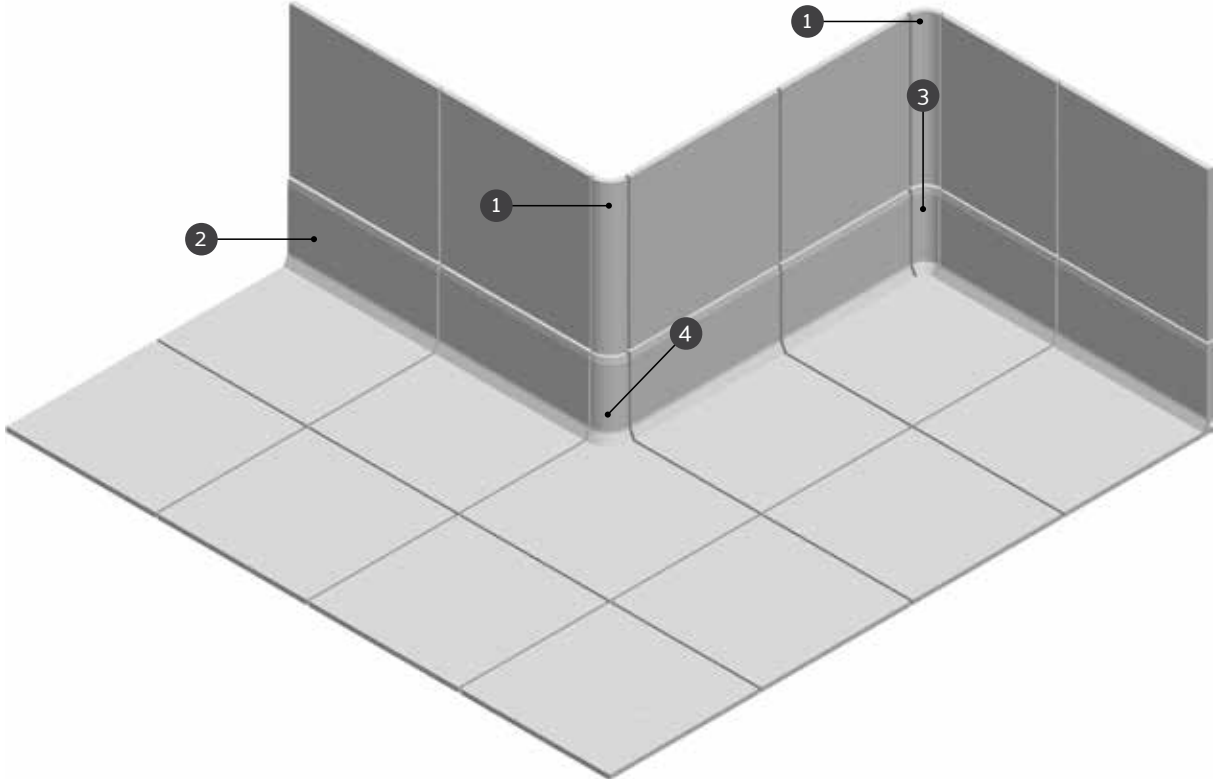

Function

Round angled sit-on set 8mm
Dairesel dönüş parçaları sit-on 8mm



1  Internal - external beading sit-on
İç dış profil sit-on

2  Covebase sit-on
Kenar dönüş parçası sit-on

3  Covebase external corner sit-on
Dış köşe dönüş parçası sit-on

4  Covebase internal corner sit-on
İç köşe dönüş parçası sit-on

Complementary pieces Tamamlayıcı parçalar

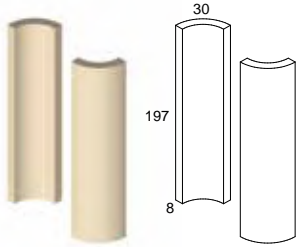

Internal-external beading sit-on

İç dış profil sit-on

M 3 x 20 cm / 1"x 8"

8mm

IDP320

Uni



Uni ivory
Uni fildişi
K86801300001VTE0



Uni grey
Uni gri
K86909600001VTE0



Uni black
Uni siyah
K94950200001VTE0

Dots



Dotti ivory
Dotti fildişi
K94949900001VTE0



Dotti light grey
Dotti açık gri
K94950000001VTE0



Dotti dark grey
Dotti koyu gri
K94950100001VTE0

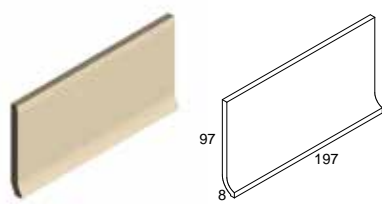

Covebase sit-on

Kenar dönüş parçası sit-on

M 10 x 20 cm / 4"x 8"

8mm

KDO1020

Uni



Uni ivory
Uni fildişi
K77037200001VTE0



Uni grey
Uni gri
K86083600001VTE0



Uni black
Uni siyah
K91237000001VTE0

Dots



Dotti ivory
Dotti fildişi
K77036100001VTE0



Dotti light grey
Dotti açık gri
K77038300001VTE0



Dotti dark grey
Dotti koyu gri
K77039400001VTE0

Function

Round angled sit-on set 8mm
Dairesel dönüş parçaları sit-on 8mm

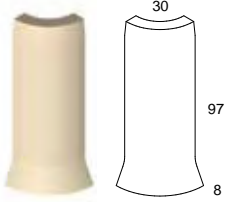

Covebase external corner sit-on

Dış köşe dönüş parçası sit-on

M 3 x 10 cm / 1"x 4"

8mm

DKO310

Uni



Uni ivory
Uni fildişi
K77045300001VTEO



Uni grey
Uni gri
K94947300001VTEO



Uni black
Uni siyah
K84712100001VTEO

Dots



Dotti ivory
Dotti fildişi
K77044200001VTEO



Dotti light grey
Dotti açık gri
K77046400001VTEO



Dotti dark grey
Dotti koyu gri
K77047500001VTEO

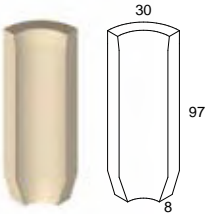

Covebase internal corner sit-on

İç köşe dönüş parçası sit-on

M 3 x 10 cm / 1"x 4"

8mm

IK310

Uni



Uni ivory
Uni fildişi
K77041600001VTEO



Uni grey
Uni gri
K94947100001VTEO



Uni black
Uni siyah
K94947200001VTEO

Dots



Dotti ivory
Dotti fildişi
K77040500001VTEO



Dotti light grey
Dotti açık gri
K77042000001VTEO



Dotti dark grey
Dotti koyu gri
K77043100001VTEO

Covebase bullnose set 6mm
Kenar dönüş ve yuvarlak kenarlı bitiş parçaları 6mm

Complementary pieces
Tamamlayıcı parçalar

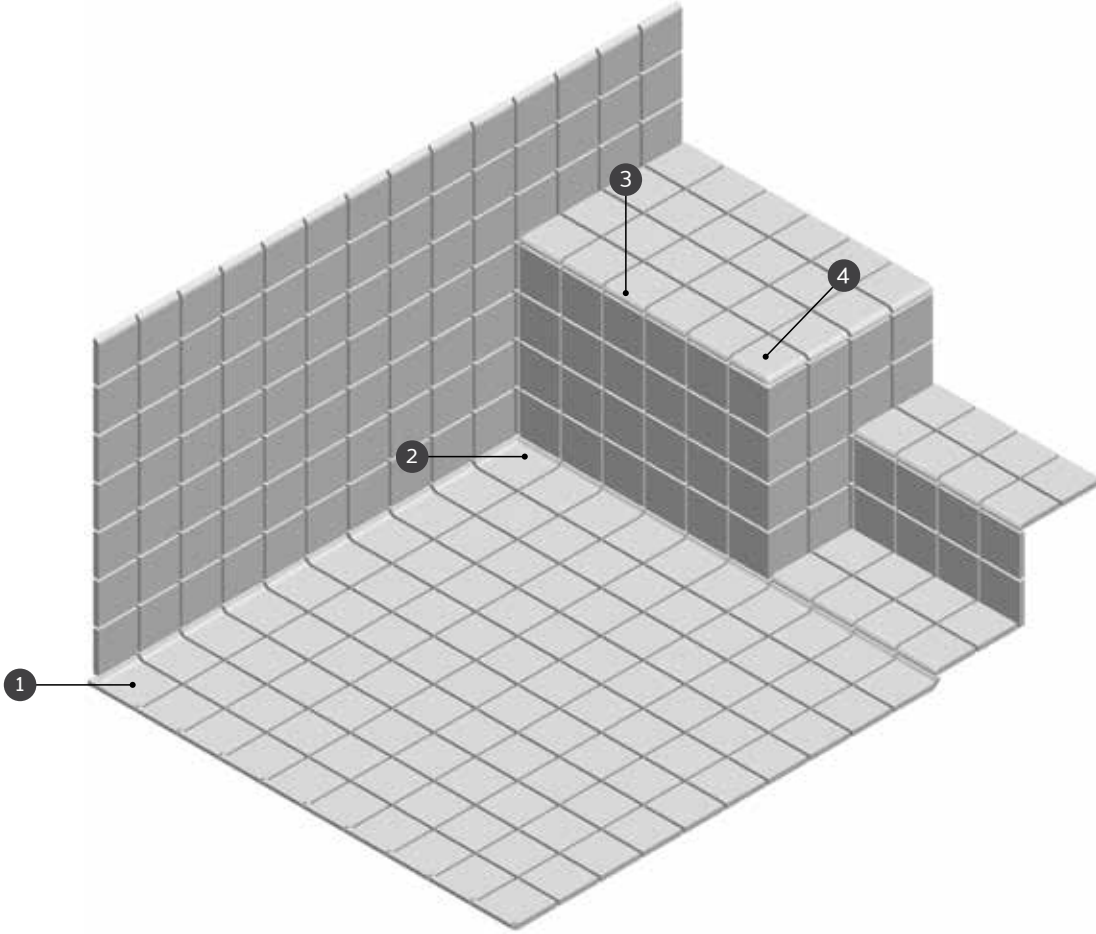

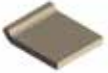
1  Covebase
Kenar dönüş parçası

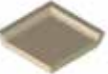
2  Covebase internal corner
Çift kenar dönüş parçası

3  Bullnose
Bullnose

4  Bullnose corner
Bullnose köşe

Function

Covebase bullnose set 6mm
Kenar dönüş ve yuvarlak kenarlı bitiş parçaları 6mm

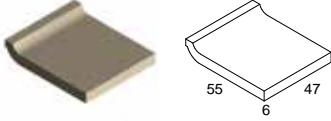

Covebase
Kenar dönüş parçası
M 5 x 5 cm / 2"x 2"
6mm
KDY55

Uni



Uni ivory
Uni fildişi
K86191230001VTEo



Uni grey
Uni gri
K86624130001VTEo



Uni black
Uni siyah
K94950930001VTEo

Dots



Dotti ivory
Dotti fildişi
K86192330001VTEo



Dotti light grey
Dotti açık gri
K94950730001VTEo



Dotti dark grey
Dotti koyu gri
K94950830001VTEo

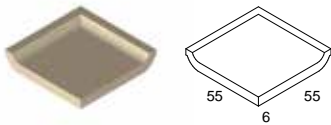

Covebase internal corner
Çift kenar dönüş parçası
M 5 x 5 cm / 2"x 2"
6mm
CKD55

Uni



Uni ivory
Uni fildişi
K86199300001VTEo



Uni grey
Uni gri
K94950500001VTEo



Uni black
Uni siyah
K94950600001VTEo

Dots



Dotti ivory
Dotti fildişi
K86200400001VTEo



Dotti light grey
Dotti açık gri
K94950300001VTEo



Dotti dark grey
Dotti koyu gri
K94950400001VTEo

Complementary pieces Tamamlayıcı parçalar

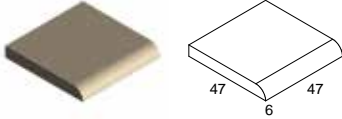

Bullnose

Bullnose

M 5 x 5 cm / 2"x 2"

6mm

S886

Uni

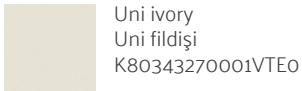

Uni ivory
Uni fildişi
K80343270001VTE0

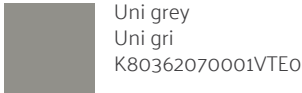

Uni grey
Uni gri
K80362070001VTE0

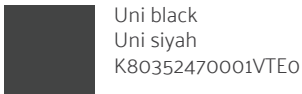

Uni black
Uni siyah
K80352470001VTE0

Dots

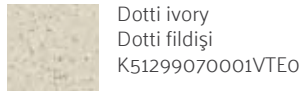

Dotti ivory
Dotti fildişi
K51299070001VTE0



Dotti light grey
Dotti açık gri
K80408470001VTE0

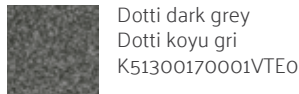

Dotti dark grey
Dotti koyu gri
K51300170001VTE0

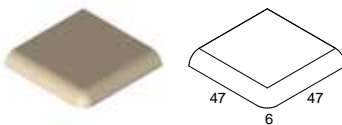

Bullnose corner

Bullnose köşe

M 5 x 5 cm / 2"x 2"

6mm

SC886

Uni



Uni ivory
Uni fildişi
K80345400001VTE0



Uni grey
Uni gri
K80364200001VTE0



Uni black
Uni siyah
K80354600001VTE0

Dots

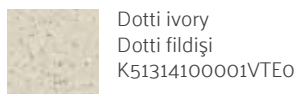

Dotti ivory
Dotti fildişi
K51314100001VTE0

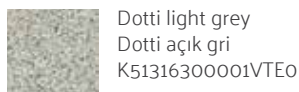

Dotti light grey
Dotti açık gri
K51316300001VTE0

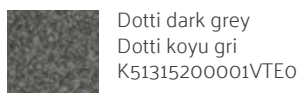

Dotti dark grey
Dotti koyu gri
K51315200001VTE0

Function

Shower inclined edge
Duş parçaları

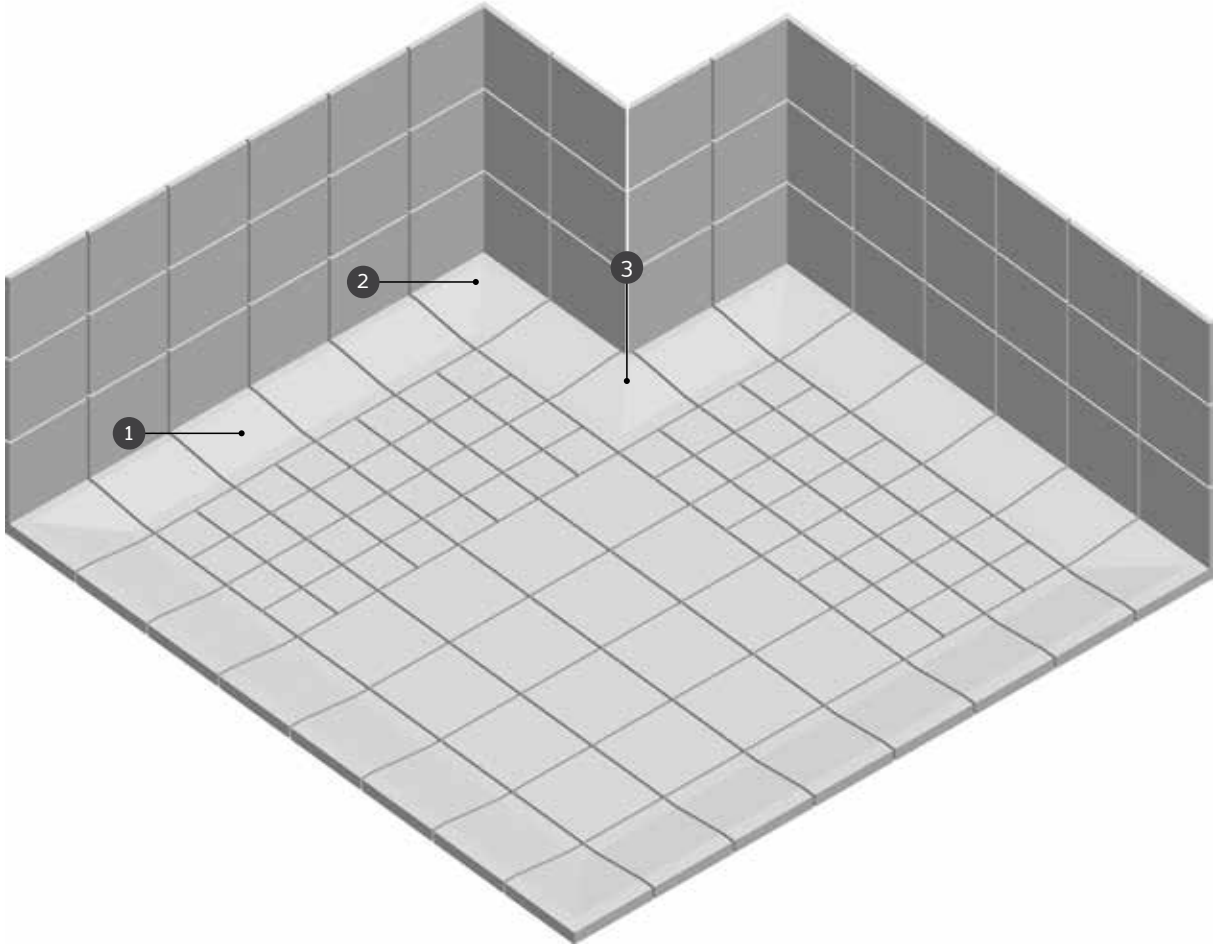

1 Shower inclined end edge
Duş parçası

2 Shower inclined end edge (internal)
Duş parçası iç köşe

3 Shower inclined end edge (external)
Duş parçası dış köşe

Complementary pieces Tamamlayıcı parçalar

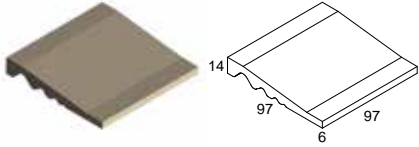

Shower inclined end edge

Duş parçası

M 10 x 10 cm / 4"x 4"

6mm / 14mm

Uni



Uni ivory
Uni fildişi
K78607600001VTE0



Uni grey
Uni gri
K80457300001VTE0



Uni black
Uni siyah
K88672600001VTE0

Dots



Dotti ivory
Dotti fildişi
K86096500001VTE0



Dotti light grey
Dotti açık gri
K86099100001VTE0



Dotti dark grey
Dotti koyu gri
K86102400001VTE0

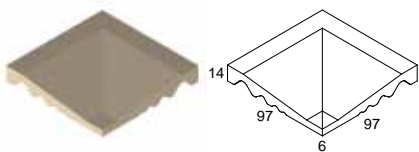

Shower inclined end edge (Internal)

Duş parçası iç köşe

M 10 x 10 cm / 4"x 4"

6mm / 14mm

Uni



Uni ivory
Uni fildişi
K78608000001VTE0



Uni grey
Uni gri
K88203500001VTE0



Uni black
Uni siyah
K88673000001VTE0

Dots



Dotti ivory
Dotti fildişi
K86097600001VTE0



Dotti light grey
Dotti açık gri
K86100200001VTE0



Dotti dark grey
Dotti koyu gri
K86103500001VTE0

Function

Shower inclined edge
Duş parçaları

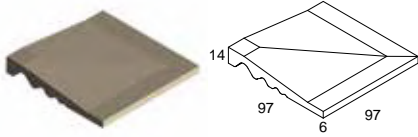

Shower inclined end edge (External)

Duş parçası dış köşe

M 10 x 10 cm / 4"x 4"

6mm / 14mm

Uni



Uni ivory
Uni fildişi
K83701500001VTEo



Uni grey
Uni gri
K84162400001VTEo



Uni black
Uni siyah
K94951100001VTEo

Dots



Dotti ivory
Dotti fildişi
K86098000001VTEo



Dotti light grey
Dotti açık gri
K86101300001VTEo



Dotti dark grey
Dotti koyu gri
K86104600001VTEo

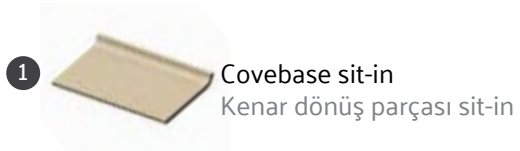
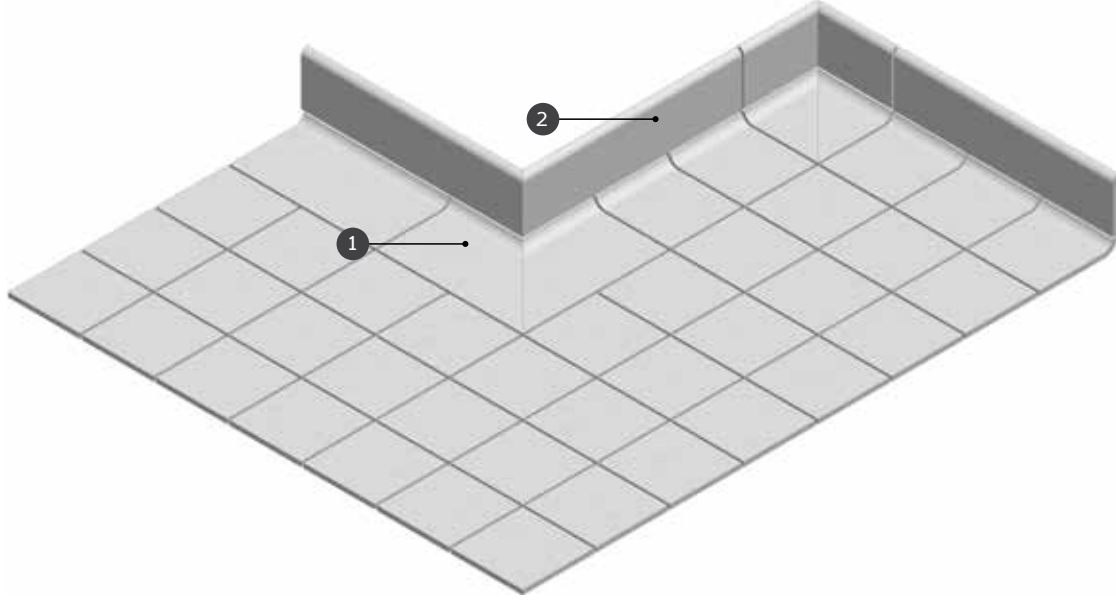

Part no 1 is produced by cutting 2 pieces of 10x20 covebase sit-in.
1 Numaralı ürün 2 adet 10x20 kenar dönüş parçası sit-in'in kesilmesiyle oluşturulmuştur.

Function

Other complementary parts
Diğer tamamlayıcı parçalar

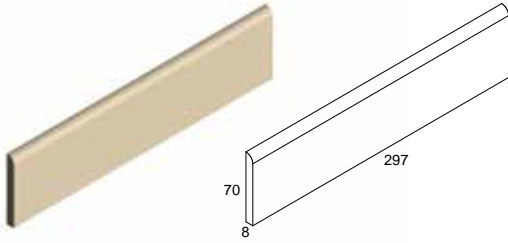

Plinth
Süpürgelik
M 7x 30cm / 3"x 12"
8mm

Uni

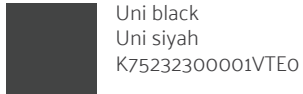
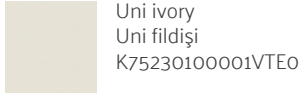

Dots

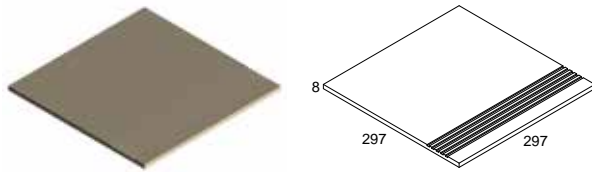
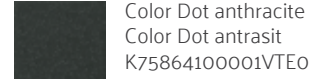
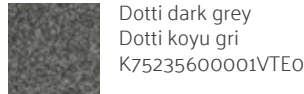
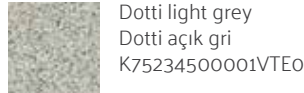
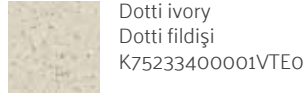

Step tread
Basamak
M 30 x 30 cm / 12"x 12"
8mm

Uni

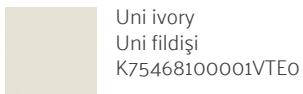

Dots

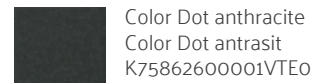
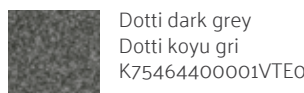
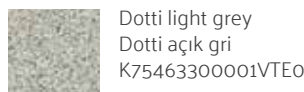



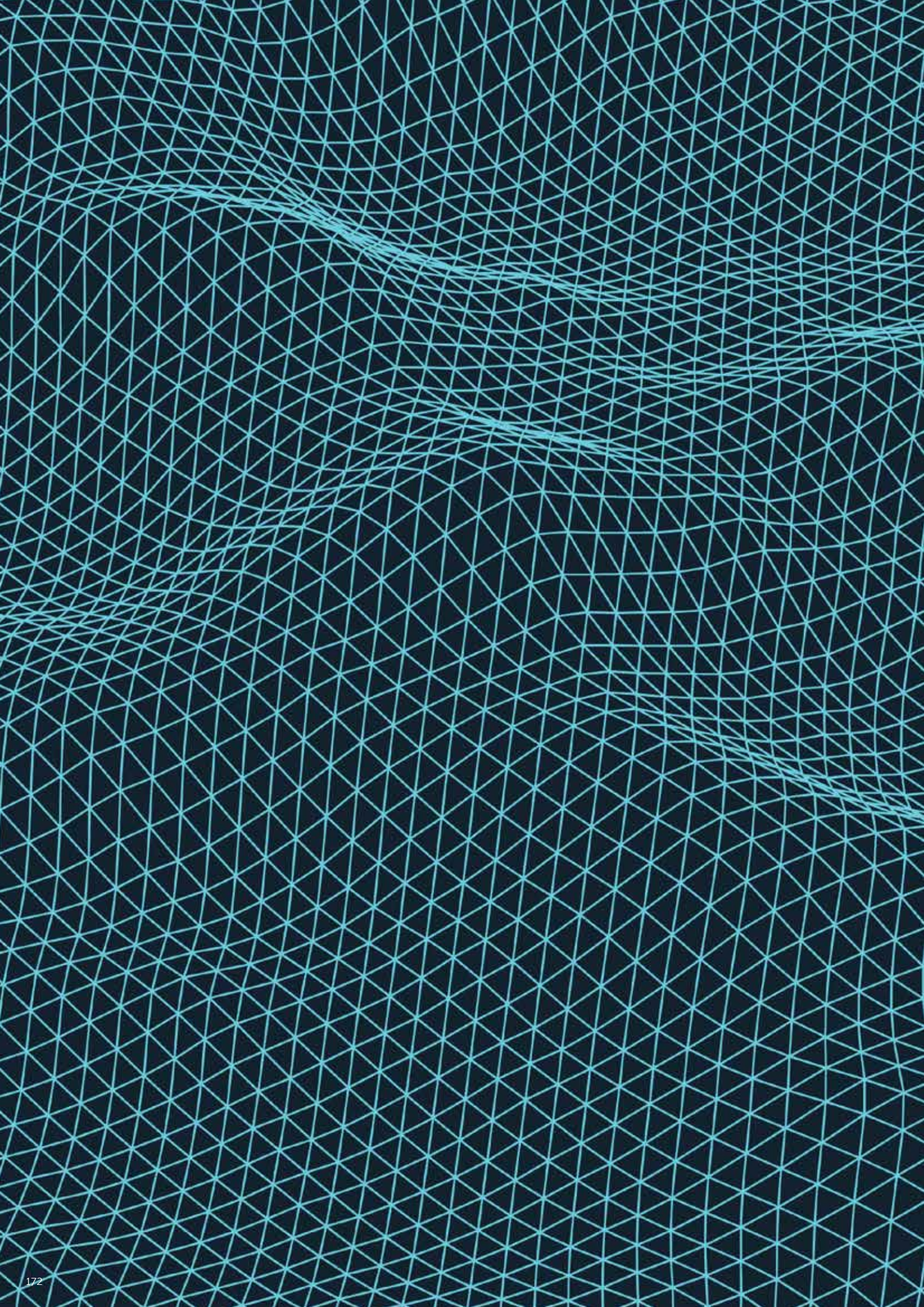

Discover Matrix

Matrix'i keşfedin

Inspiring innovative Matrix collection brings a new perspective to your designs, with unique surface options and special color pallet, giving you the chance to design any combination you would dream of.

İlham veren yenilikçi Matrix koleksiyonu, dokunma hissi uyandıran benzersiz yüzey seçenekleri ve özel renk paleti ile tasarımlarınıza yeni bir derinlik kazandırıyor, size hayal ettiğiniz kombinasyonları özgürce tasarlama şansı sunuyor.

Matrix

To imagine and create freely

VitrA Matrix offers an innovative fullbody porcelain tile collection in 6 surface options and 6 exclusive colour alternatives. Matrix brings you a simple but yet sophisticated product system with surface textures that are tempting to touch. New surface alternatives developed through VitrA's superior design and production capabilities complement the innovative Matrix System.

Hayal edip özgürce yaratmak için

VitrA Matrix, dokunma hissi uyandıran 6 yüzey seçeneği ve çok özel 6 renk alternatifleriyle yenilikçi bir porselen karo koleksiyonu sunuyor. Matrix sizi sade olduğu kadar sofistike bir ürün sistemi ile buluşturuyor. VitrA'nın üstün tasarım ve üretim yetkinliği ile hazırlanan yeni yüzey alternatifleri, yenilikçi Matrix Sistemi'ni tamamlıyor.

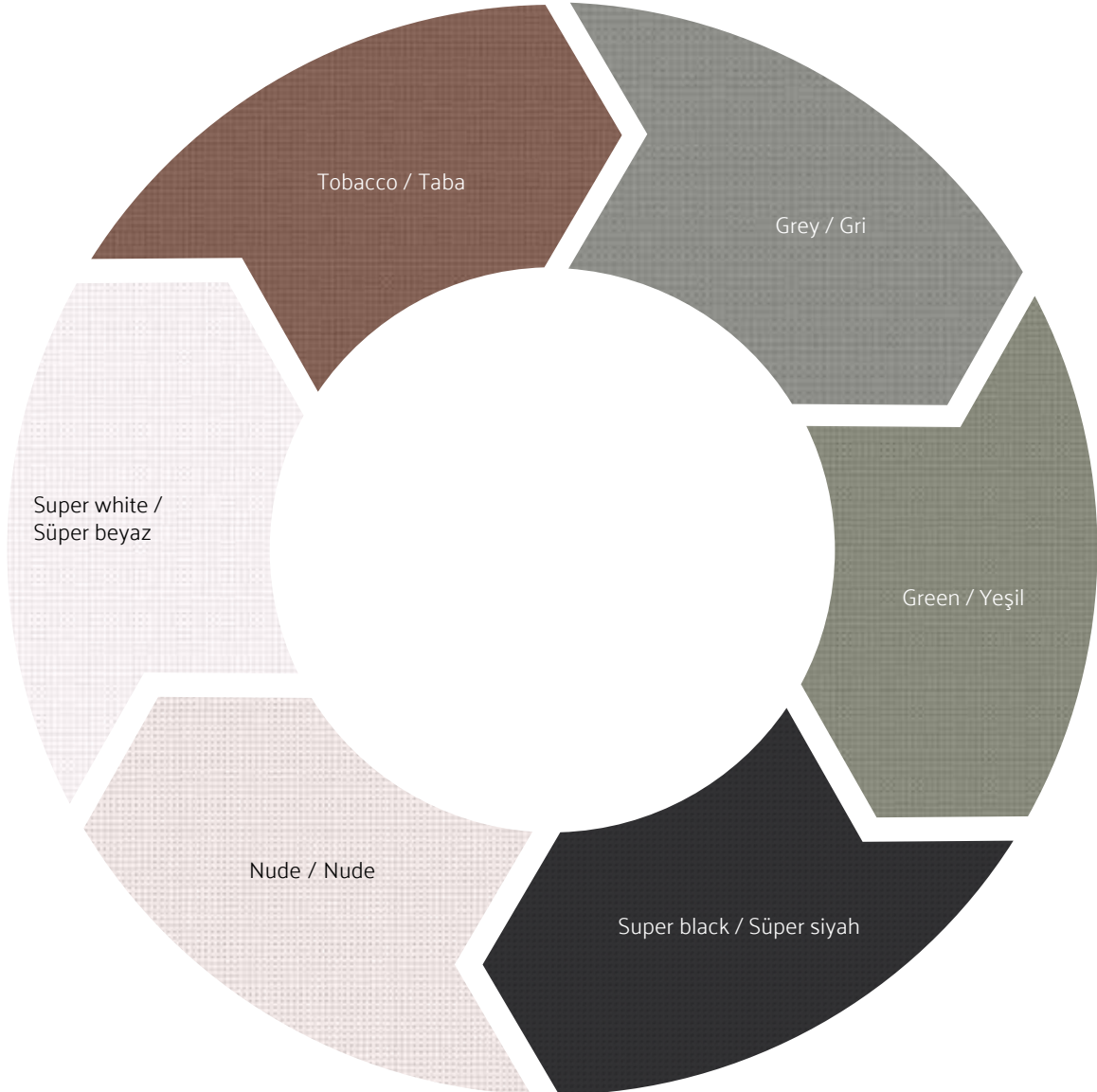

Matrix and surface

By the use of 6 surface options of Matrix, you can add new dimensions to all surfaces in your designs. With Matrix, your dreams will materialize into buildings, the surfaces in the building into attractive areas, and your designs into spaces that awaken all senses.

Matrix ve yüzey

Matrix'in 6 yüzey seçeneği ile tasarladığınız mekânların tüm yüzeylerine yeni bir boyut kazandırabilirsiniz. Matrix ile hayalleriniz binalara, yüzeyler ilgi çekici yeni özelliklere ve tasarımlarınız tüm duylara seslenen mekânlara dönüşecek.

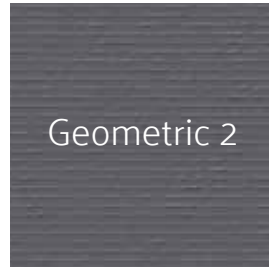
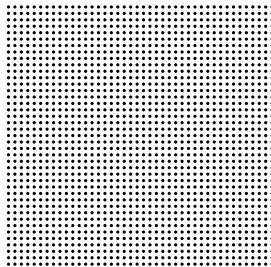
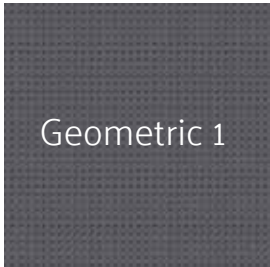
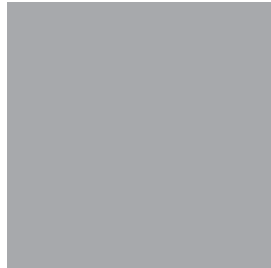
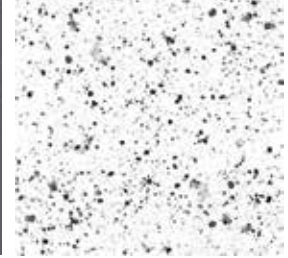
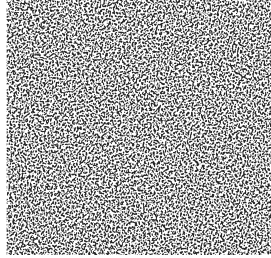

Matrix

Random 1

Random 2

Plain

Geometric 1

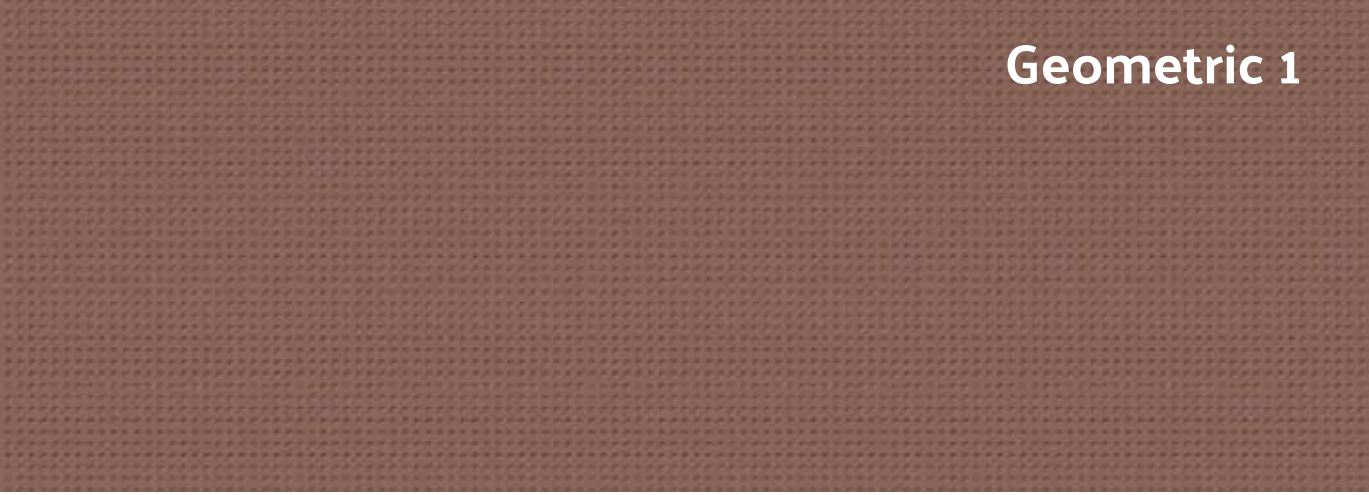

Geometric 2



Flake

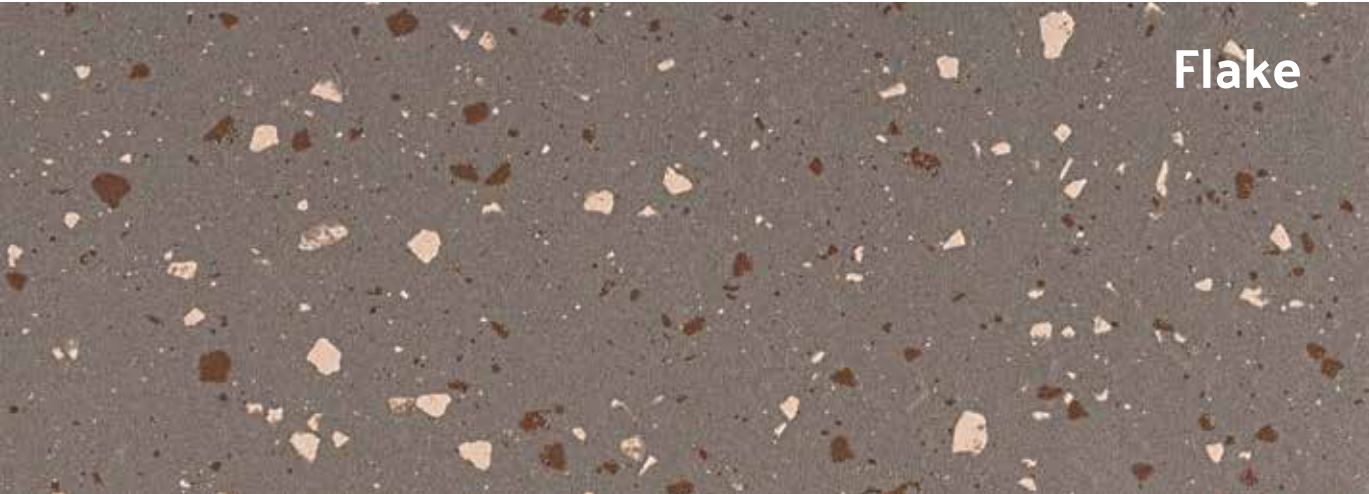

Matrix

Random





Floor tiles / Yer karoları : K944647R0001VTE0 60x60 Matrix Plain Tobacco / Taba

Wall tiles / Duvar karoları : K944664R0001VTE0 60x60 Matrix Random 1 Super white / Süper beyaz
K944650R0001VTE0 60x60 Matrix Plain Nude / Nude

Matrix

Random 1

PRO

Technic

Porcelain tiles / Porselen karolar

Body type / Būnye tipi

Fullbody

Surface alternatives / Yūzey alternatifleri

R11C

Base tile sizes / Fon ebatları

60x60 cm (R 597x597x9 mm)

30x60 cm (R 297x597x9 mm)

Base tile colors / Fon renkleri

Super white / Sūper beyaz

Nude / Nude

Tobacco / Taba

Green / Yeşil

Grey / Gri

Super black / Sūper siyah

Usage areas / Kullanım alanları

Residential / Konut

Commercial / Ticari alan

Tiling areas / Dōşeme alanları

Floor / Yer

Wall / Duvar

Frost resistance / Dona dayanım

Available / Var

Shade variation classification /

Desen farklılaşması

V0

Product standard / Ūrūn standardı

EN14411 Group B1a:

Fullbody porcelain tiles / Fullbody porselen karolar

Random 1

Matrix Random 1 has a high-quality texture on its organic surface. Its unique surface triggers a desire to touch and feel its vibrations.

Matrix Random 1 organik yūzeyi ile gūçlü yapıda bir dokuya sahip. Benzersiz yūzeyi dokunma ve titreşimlerini hissetme isteęi uyandırıyor.



Porcelain
Porselen



Floor tile
Yer karosu



Wall tile
Duvar karosu



Facade
Dış cephe



Havuz çevresi
Pool surrounding



Outdoors
Dış mekânlar



Residential
Konut



Commercial
Ticari alan



Frost resistance
Dona dayanım



Shade variation
Desen farklılaşması



Matt
Mat



Rectified
Rektifiyeli

Matrix

Random 2

PRO

Technic

Porcelain tiles / Porselen karolar

Body type / Bnye tipi

Fullbody

Surface alternatives / Yzey alternatifleri

R11B

Base tile sizes / Fon ebatları

60x60 cm (R 597x597x9 mm)

30x60 cm (R 297x597x9 mm)

Base tile colors / Fon renkleri

Super white / Sper beyaz

Nude / Nude

Tobacco / Taba

Green / Yeřil

Grey / Gri

Super black / Sper siyah

Usage areas / Kullanım alanları

Residential / Konut

Commercial / Ticari alan

Tiling areas / Dřeme alanları

Floor / Yer

Wall / Duvar

Frost resistance / Dona dayanım

Available / Var

Shade variation classification /

Desen farklılařması

V0

Product standard / rn standardı

EN14411 Group B1a:

Fullbody porcelain tiles / Fullbody porselen karolar

Random 2

Matrix Random 2 has an appearance that adds depth to the spaces, with its wavy surface. It can easily be laid together with natural-looking tiles. With their unique surface, Matrix Random 2 tiles can be combined with natural-looking tiles harmoniously but also they can be used on their own.

Matrix Random 2 dalgalı yzeyi ile meknlara derinlik katan bir grnme sahip. Eřsiz yzeyi ve çekici renkleri ile kendi bařına kullanılabileceęi gibi doęal malzeme grnml karolarla da uyum iinde dřenebilir.



Matrix

Plain





Floor tiles / Yer karoları : K944663R0001VTE0 M60x60 Matrix Plain Super white / Süper beyaz

Wall tiles / Duvar karoları : K944669R0001VTE0 M60x60 Matrix Random 1 Super black / Süper siyah

Matrix

Plain

PRO

Technic

Porcelain tiles / Porselen karolar

Body type / Būnye tipi

Fullbody porcelain / Fullbody porselen

Surface alternatives / Yūzey alternatifleri

R10A

Base tile sizes / Fon ebatları

60x60 cm (R 597x597x9 mm)

30x60 cm (R 297x597x9 mm)

Base tile colors / Fon renkleri

Super white / Sūper beyaz

Nude / Nude

Tobacco / Taba

Green / Yeşil

Grey / Gri

Super black / Sūper siyah

Usage areas / Kullanım alanları

Residential / Konut

Commercial / Ticari alan

Tiling areas / Dōşeme alanları

Floor / Yer

Wall / Duvar

Frost resistance / Dona dayanım

Available / Var

Shade variation classification /

Desen farklılaşması

V0

Product standard / Ūrūn standardı

EN14411 Group B1a:

Fullbody porcelain tiles / Fullbody porselen karolar

Plain

Matrix Plain offers a surface that awakes the senses and creates a desire to touch. Its silky surface creates a warm feel and a natural look. One touch on its surface can make you envision the atmospheres you can create with this uniform surface.

Matrix Plain duyguları uyandıran ve dokunma hissi yaratan bir yūzey sunuyor. İpekli yūzeyi sıcak bir atmosfer ve doğallık hissi yaratıyor. Matrix Plain yūzeyine dokunulduğunda yalnızca dokusunu deęil, kullanıldığı alanın atmosferini de hissettiriyor.



Porcelain
Porselen



Floor tile
Yer karosu



Wall tile
Duvar karosu



Facade
Dış cephe



Havuz çevresi
Pool surrounding



Outdoors
Dış mekânlar



Residential
Konut



Commercial
Ticari alan



Frost resistance
Dona dayanım



Shade variation
Desen farklılaşması



Matt
Mat



Rectified
Rektifiyeli

Matrix

Geometric





Wall tiles / Duvar karoları : K944656R0001VTEO 60x60 Matrix Plain Green / Yeşil
K944666R0001VTEO 60x60 Matrix Geometric 1 Super black / Süper siyah
K944667R0001VTEO 60x60 Matrix Geometric 2 Super black / Süper siyah

PRO

Technic

Porcelain tiles / Porselen karolar

Body type / Bünye tipi

Fullbody porcelain / Fullbody porselen

Surface alternatives / Yüzey alternatifleri

R11B

Base tile sizes / Fon ebatları

60x60 cm (R 597x597x9 mm)
30x60 cm (R 297x597x9 mm)

Base tile colors / Fon renkleri

Super white / Süper beyaz
Nude / Nude
Tobacco / Taba
Green / Yeşil
Grey / Gri
Super black / Süper siyah

Usage areas / Kullanım alanları

Residential / Konut
Commercial / Ticari alan

Tiling areas / Döşeme alanları

Floor / Yer
Wall / Duvar

Frost resistance / Dona dayanım

Available / Var

Shade variation classification / Desen farklılaşması

Vo

Product standard / Ürün standardı

EN14411 Group B1a:
Fullbody porcelain tiles /
Fullbody porselen karolar

Geometric 1

Matrix Geometric 1 is an exclusive surface with a bold look. Its 3D surface texture is designed to serve classy and attractive space designs. Its geometric texture adds a strong image effect to any colour and amplifies the effect of the colour used.

Matrix Geometric 1 güçlü görselliğiyle çok özel bir yüzey. Benzersiz 3 boyutlu tasarımı ve zarif görünümüyle mükemmel alanlar yaratmanız için tasarlandı. Dokusu renklerin daha etkileyici görünmesini sağlıyor, kullanıldığı her yüzey onunla daha güçlü görünüyor.



PRO

Technic

Porcelain tiles / Porselen karolar

Body type / Būnye tipi

Fullbody porcelain / Fullbody porselen

Surface alternatives / Yūzey alternatifleri

R10B

Base tile sizes / Fon ebatları

60x60 cm (R 597x597x9 mm)

30x60 cm (R 297x597x9 mm)

Base tile colors / Fon renkleri

Super white / Sūper beyaz

Nude / Nude

Tobacco / Taba

Green / Yeşil

Grey / Gri

Super black / Sūper siyah

Usage areas / Kullanım alanları

Residential / Konut

Commercial / Ticari alan

Tiling areas / Dōşeme alanları

Floor / Yer

Wall / Duvar

Frost resistance / Dona dayanım

Available / Var

Shade variation classification /

Desen farklılaşması

V0

Product standard / Ūrūn standardı

EN14411 Group B1a:

Fullbody porcelain tiles /

Fullbody porselen karolar

Geometric 2

Matrix Geometric 2 with its linear texture adds a modest look with a character to the spaces it is used. Capable of creating different effects with different colours, its special surface is ideal for creating modern living areas.

Matrix Geometric 2 lineer tasarımıyla kullanıldığı mekânlara yalın ve özgün karakterli bir görünüm kazandırıyor. Farklı renklerle farklı etkiler yaratabilen özel yüzeyi modern yaşam alanları yaratmak için ideal.



Porcelain
Porselen



Floor tile
Yer karosu



Wall tile
Duvar karosu



Facade
Dış cephe



Havuz çevresi
Pool surrounding



Outdoors
Dış mekânlar



Residential
Konut



Commercial
Ticari alan



Frost resistance
Dona dayanım



Shade variation
Desen farklılaşması



Matt
Mat



Rectified
Rektifiyeli

Matrix

Flake



Floor tiles / Yer karoları : K94418700001VTE0 30x30 Matrix Flake Grey / Gri



Matrix

Flake



PRO

Technic

Flake

A ceramic series complementing the unique Matrix system with special colours and fullbody porcelain body. Its mini terrazzo textured surface can be used in harmony with other products of the Matrix collection and inspires creativity with Mix&Match alternatives. Thanks to its timeless design and fullbody porcelain structure, Matrix Flake offers extra-wear-resistant solutions even for high-traffic areas.

Benzersiz Matrix sistemini özel renkleri ve taneli fullbody porselen yapısıyla tamamlayan seramik serisi. Mini terrazzo etkili dokusu ile Matrix koleksiyonunun diğer ürünleri ile uyum içinde kullanılıyor ve Mix&Match alternatifleri ile yaratıcılığa ilham veriyor. Matrix Flake, zamansız tasarımı ve fullbody porselen yapısı sayesinde yüksek trafikli alanlarda bile aşınmaya ekstra dayanıklı çözümler sunuyor.

Porcelain Tiles / Porselen Karolar

Body type / Bünye tipi

Fullbody porselen / Fullbody porcelain

Surface alternatives / Yüzey alternatifleri

R10

R9

Base tile sizes / Fon ebatları

M30x30 cm (297x297x8 mm)

M30x30 cm (297x297x12 mm)

30x60 cm (R 297x597x9 mm)

60x60 cm (R 597x597x9 mm)

Basic tile and decor colors /

Fon ve dekor renkleri

Flake

White / Beyaz

Grey / Gri

Black / Siyah

Color Flake

White / Beyaz

(Nude & Tobacco Flake / Nude & Taba Flake)

Grey / Gri

(Nude & Tobacco Flake / Nude & Taba Flake)

Black / Siyah

(White / Green Flake / Beyaz & Yeşil Flake)

Usage areas / Kullanım alanları

Residential / Konut

Commercial / Ticari alan

Tiling areas / Döşeme alanları

Floor / Yer

Wall / Duvar

Frost resistance / Dona dayanım

Available / Var

Shade variation classification /

Desen farklılaşması

V1

Product standard / Ürün standardı

EN14411 Group B1a:

Fullbody porcelain tiles /

Fullbody porselen karolar



Porcelain
Porselen



Floor tile
Yer karosu



Wall tile
Duvar karosu



Havuz çevresi
Pool surrounding



Outdoors
Dış mekânlar



Residential
Konut



Commercial
Ticari alan



Frost resistance
Dona dayanım



Shade variation
Desen farklılaşması



Matt
Mat



Non-Rectified
Rektifiyesiz



Rectified
Rektifiyeli



Fullbody porcelain
Fullbody porselen



Porcelain
Porselen



Residential
Konut



Commercial
Ticari alan



Frost resistance
Dona dayanım



Matt
Mat



Non-Rectified
Rektifiyesiz

Color options in size order
Ebatlara göre renk dizilimi

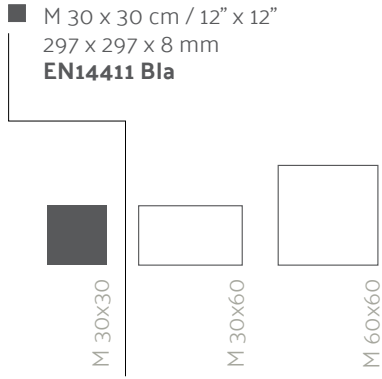

Flake



White / Beyaz
R9
K94379200001VTEO
R9 - 12 mm
K94379300001VTEO
R10
K94418900001VTEO

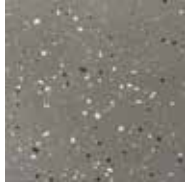

Gri / Grey
R9
K94418700001VTEO
R9 - 12 mm
K94419200001VTEO
R10
K94419000001VTEO



Siyah / Black
R9
K94418800001VTEO
R10
K94419100001VTEO

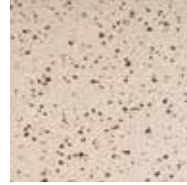

White / Beyaz
Matt / Mat
K94639700001VTEO



Gri / Grey
Matt / Mat
K94639800001VTEO



Siyah / Black
Matt / Mat
K94639900001VTEO

Matrix

Fullbody porcelain
Fullbody porselen



Porcelain
Porselen



Residential
Konut



Commercial
Ticari alan



Frost resistance
Dona dayanım



Matt
Mat



Rectified
Rektifiyeli

■ M 30 x 60 cm / 12" x 24"
297 x 597 x 9 mm
EN14411 Bla



M 30x30



M 30x60



M 60x60

Random 1



Super white / Süper beyaz
R11C
K945222R0001VTEo



Nude / Nude
R11C
K945212R0001VTEo



Tobacco / Taba
R11C
K945209R0001VTEo



Green / Yeşil
R11C
K945199R0001VTEo



Grey / Gri
R11C
K946343R0001VTEo



Super black / Süper siyah
R11C
K945197R0001VTEo

Random 2



Super white / Süper beyaz
R11B
K945223R0001VTEo



Nude / Nude
R11B
K945213R0001VTEo



Tobacco / Taba
R11B
K945217R0001VTEo



Green / Yeşil
R11B
K945218R0001VTEo



Grey / Gri
R11B
K946344R0001VTEo



Super black / Süper siyah
R11B
K945198R0001VTEo

Plain



Super white / Süper beyaz
R10A
K945221R0001VTEo

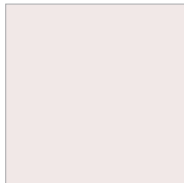

Nude / Nude
R10A
K945211R0001VTEo



Tobacco / Taba
R10A
K945208R0001VTEo



Green / Yeşil
R10A
K945216R0001VTEo



Grey / Gri
R10A
K946342R0001VTEo



Super black / Süper siyah
R10A
K945226R0001VTEo

Fullbody porcelain
Fullbody porselen



Porcelain
Porselen



Residential
Konut



Commercial
Ticari alan



Frost resistance
Dona dayanım



Matt
Mat



Rectified
Rektifiyeli

Color options in size order
Ebatlara göre renk dizilimi

M 30 x 60 cm / 12" x 24"
297 x 597 x 9 mm
EN14411 Bla



M 30x30



M 30x60



M 60x60

Geometric 1

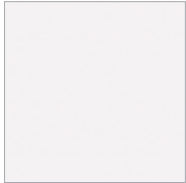

Super white / Süper beyaz
R11B
K945219R0001VTEO

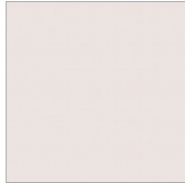

Nude / Nude
R11B
K945201R0001VTEO



Tobacco / Taba
R11B
K945206R0001VTEO



Green / Yeşil
R11B
K945214R0001VTEO



Grey / Gri
R11B
K946340R0001VTEO



Super black / Süper siyah
R11B
K945224R0001VTEO

Geometric 2



Super white / Süper beyaz
R10B
K945220R0001VTEO



Nude / Nude
R10B
K945210R0001VTEO

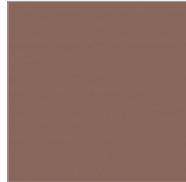

Tobacco / Taba
R10B
K945207R0001VTEO



Green / Yeşil
R10B
K945215R0001VTEO



Grey / Gri
R10B
K946341R0001VTEO



Super black / Süper siyah
R10B
K945225R0001VTEO

Flake



White / Beyaz
Matt / Mat
K947123R0001VTEO



Grey / Gri
Matt / Mat
K947124R0001VTEO



Black / Siyah
Matt / Mat
K947125R0001VTEO



White / Beyaz
Matt / Mat
K947126R0001VTEO



Grey / Gri
Matt / Mat
K947127R0001VTEO



Black / Siyah
Matt / Mat
K947128R0001VTEO

Matrix

Fullbody porcelain
Fullbody porselen



Porcelain
Porselen



Residential
Konut



Commercial
Ticari alan



Frost resistance
Dona dayanım



Matt
Mat



Non-Rectified
Rektifiyesiz

■ M 60 x 60 cm / 24" x 24"
597 x 597 x 9 mm
EN14411 Bla



M 30x30



M 30x60



M 60x60

Random 1

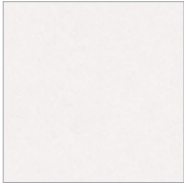

Super white / Süper beyaz
R11C
K944664R0001VTE0



Nude / Nude
R11C
K944652R0001VTE0



Taba / Tobacco
R11C
K944648R0001VTE0



Yeşil / Green
R11C
K945035R0001VTE0



Grey / Gri
R11C
K946338R0001VTE0



Super black / Süper siyah
R11C
K944669R0001VTE0

Random 2



Super white / Süper beyaz
R11B
K944665R0001VTE0



Nude / Nude
R11B
K944653R0001VTE0



Tobacco / Taba
R11B
K944658R0001VTE0



Green / Yeşil
R11B
K944659R0001VTE0



Grey / Gri
R11B
K946339R0001VTE0



Super black / Süper siyah
R11B
K944670R0001VTE0

Plain

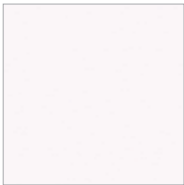

Super white / Süper beyaz
R10A
K944663R0001VTE0

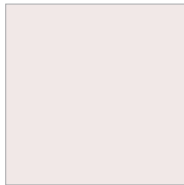

Nude / Nude
R10A
K944650R0001VTE0



Tobacco / Taba
R10A
K944647R0001VTE0



Green / Yeşil
R10A
K944656R0001VTE0



Grey / Gri
R10A
K946337R0001VTE0



Super black / Süper siyah
R10A
K944668R0001VTE0

Fullbody porcelain
Fullbody porselen



Color options in size order
Ebatlara göre renk dizilimi

■ M 60 x 60 cm / 24" x 24"
597 x 597 x 9 mm
EN14411 Bla



M 30x30



M 30x60



M 60x60

Geometric 1

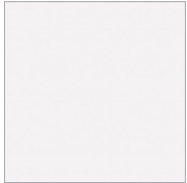

Super white / Süper beyaz
R11B
K944660R0001VTE0

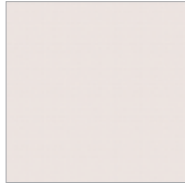

Nude / Nude
R11B
K944639R0001VTE0



Tobacco / Taba
R11B
K944645R0001VTE0



Green / Yeşil
R11B
K944654R0001VTE0



Grey / Gri
R11B
K946335R0001VTE0



Super black / Süper siyah
R11B
K944666R0001VTE0

Geometric 2



Super white / Süper beyaz
R10B
K944661R0001VTE0



Nude / Nude
R10B
K944649R0001VTE0

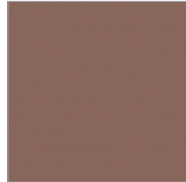

Tobacco / Taba
R10B
K944646R0001VTE0



Green / Yeşil
R10B
K944655R0001VTE0



Grey / Gri
R10B
K946336R0001VTE0



Super black / Süper siyah
R10B
K944667R0001VTE0

Flake



White / Beyaz
Matt / Mat
K947055R0001VTE0

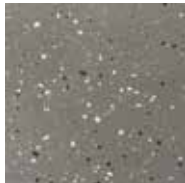

Grey / Gri
Matt / Mat
K947056R0001VTE0



Black / Siyah
Matt / Mat
K947057R0001VTE0



White / Beyaz
Matt / Mat
K947058R0001VTE0



Grey / Gri
Matt / Mat
K947059R0001VTE0



Black / Siyah
Matt / Mat
K947059R0001VTE0

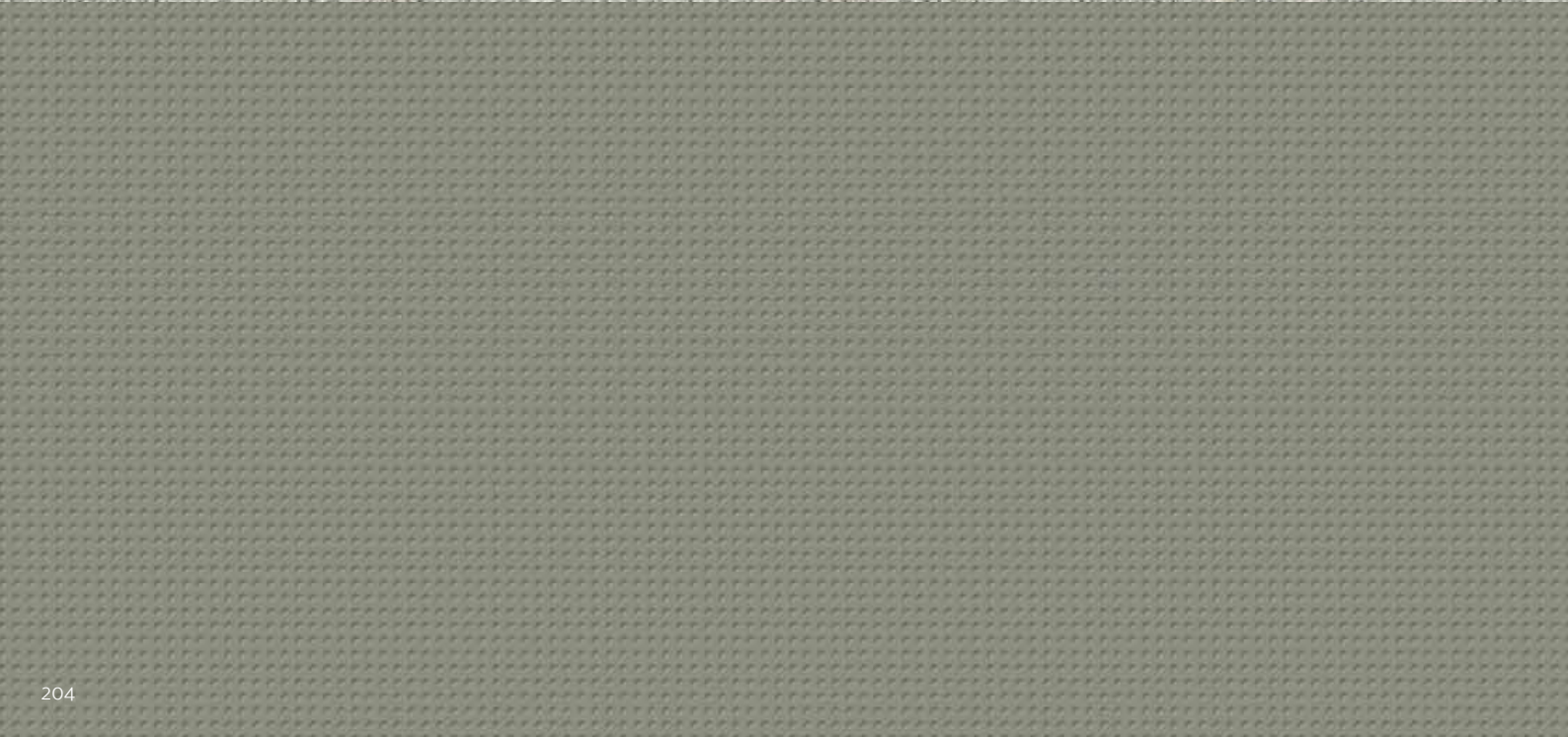
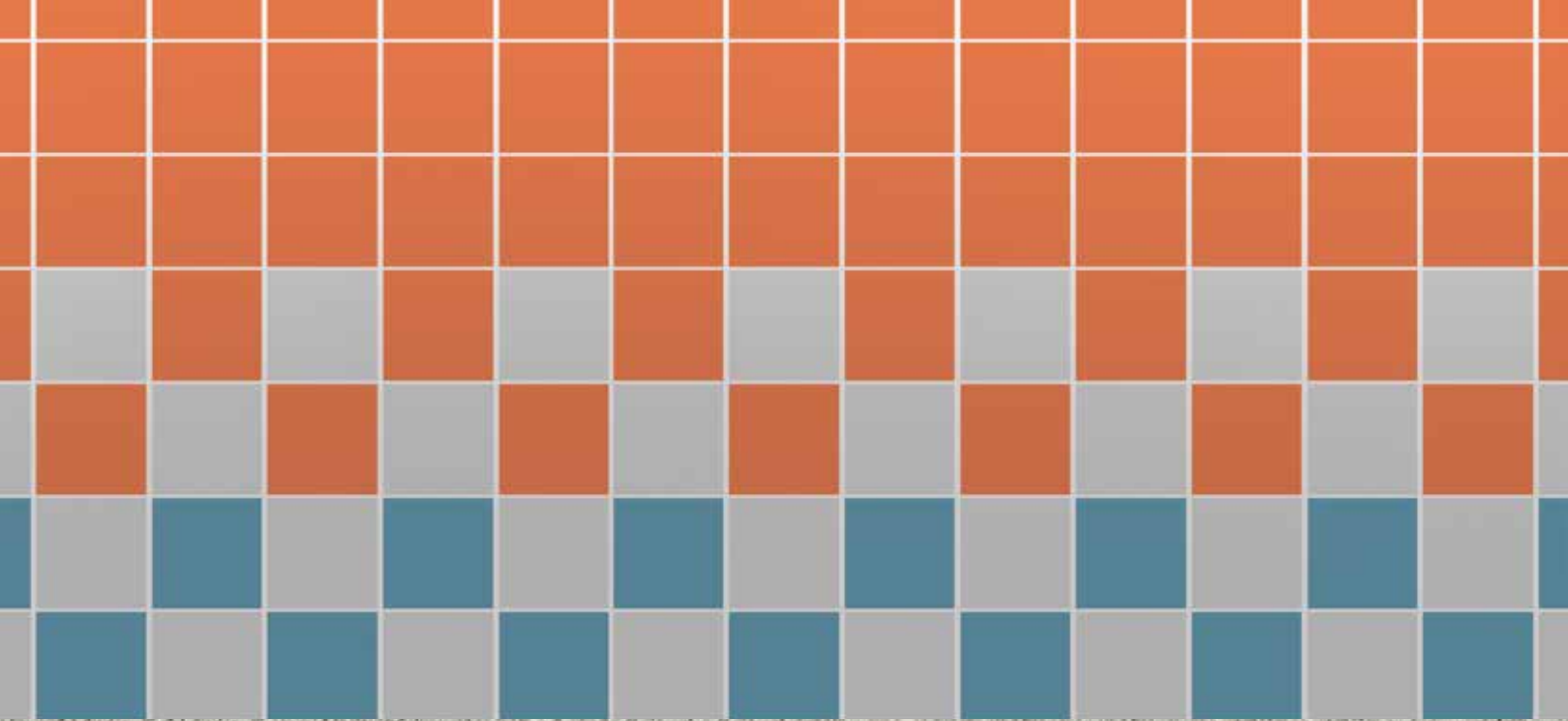

Price list

Fiyat listesi

Color

Product Code Ürün kodu	Product Name Ürün adı	Euro		Thickness (mm) Kalınlık (mm)	Box Kutu		Pallet Palet		
		m ²	Pcs Ad.		Pcs Ad.	m ²	kg	Box Kutu	m ²

2.5x2.5 Glossy

K53382480001VTE0	2.5x2.5 Color RAL 1009005 Ultra White Glossy (NN)	58,25		6	11	1,00	11,00	42	42,00	487,00
K02776280001VTE0	2.5x2.5 Color RAL 0809005 Cream Glossy (NN)	58,25		6	11	1,00	11,00	42	42,00	487,00
K02780680001VTE0	2.5x2.5 Color RAL 0958010 Light Mink Glossy (NN)	58,25		6	11	1,00	11,00	42	42,00	487,00
K02790280001VTE0	2.5x2.5 Color RAL 2307015 Pool Blue Glossy (NN)	58,25		6	11	1,00	11,00	42	42,00	487,00
K02769280001VTE0	2.5x2.5 Color RAL 7047 Light Grey Glossy (NN)	57,00		6	11	1,00	11,00	42	42,00	487,00
K02771480001VTE0	2.5x2.5 Color RAL 9016 White Glossy (NN)	57,00		6	11	1,00	11,50	42	42,00	508,00
K02975580001VTE0	2.5x2.5 Color RAL 0007500 Greige Glossy (NN)	62,70		6	11	1,00	11,00	42	42,00	487,00
K54224680001VTE0	2.5x2.5 Color RAL 1008080 Lime Green Glossy (NN)	64,00		6	11	1,00	11,00	42	42,00	487,00
K54225080001VTE0	2.5x2.5 Color RAL 1105050 Green Glossy (NN)	64,00		6	11	1,00	11,00	42	42,00	487,00
K54196680001VTE0	2.5x2.5 Color RAL 2006020 Turquoise Glossy (NN)	64,00		6	11	1,00	11,00	42	42,00	487,00
K02787680001VTE0	2.5x2.5 Color RAL 2008020 Calipso Glossy (NN)	64,00		6	11	1,00	11,00	42	42,00	487,00
K02792480001VTE0	2.5x2.5 Color RAL 2606030 Cool Blue Glossy (NN)	64,00		6	11	1,00	11,00	42	42,00	487,00
K02901180001VTE0	2.5x2.5 Color RAL 0005500 Dark Grey Glossy (NN)	68,90		6	11	1,00	11,00	42	42,00	487,00
K02761180001VTE0	2.5x2.5 Color RAL 1018 Yellow Glossy (NN)	70,25		6	11	1,00	11,00	42	42,00	487,00
K54195580001VTE0	2.5x2.5 Color RAL 2404020 Ocean Blue Glossy (NN)	70,25		6	11	1,00	11,00	42	42,00	487,00
K02791380001VTE0	2.5x2.5 Color RAL 2603035 Aqua Blue Glossy (NN)	70,25		6	11	1,00	11,00	42	42,00	487,00
K53727680001VTE0	2.5x2.5 Color RAL 2004030 Dark Turquoise Glossy (NN)	70,25		6	11	1,00	11,00	42	42,00	487,00
K02766680001VTE0	2.5x2.5 Color RAL 0001500 Black Glossy (NN)	79,30		6	11	1,00	11,00	42	42,00	487,00
K52278680001VTE0	2.5x2.5 Color RAL 0004000 Anthracite Glossy (NN)	79,30		6	11	1,00	11,00	42	42,00	487,00
K52945180001VTE0	2.5x2.5 Color RAL 2010 Orange Glossy (NN)	80,50		6	11	1,00	11,00	42	42,00	487,00
K02763380001VTE0	2.5x2.5 Color RAL 5002 Cobalt Blue Glossy (NN)	80,50		6	11	1,00	11,00	42	42,00	487,00
K52642680001VTE0	2.5x2.5 Color RAL 3000 Red Glossy (NN)	96,25		6	11	1,00	11,00	42	42,00	487,00

2.5x2.5 R10B

K52958080001VTE0	2.5x2.5 Color RAL 2307015 Pool Blue R10B (NN)	55,75		6	11	1,00	11,00	42	42,00	487,00
K53217080001VTE0	2.5x2.5 Color RAL 7047 Light Grey R10B (NN)	54,50		6	11	1,00	11,00	42	42,00	487,00
K52873680001VTE0	2.5x2.5 Color RAL 9016 White R10B (NN)	54,50		6	11	1,00	11,00	42	42,00	487,00
K53541280001VTE0	2.5x2.5 Color RAL 0007500 Greige R10B (NN)	59,90		6	11	1,00	11,00	42	42,00	487,00
K53384680001VTE0	2.5x2.5 Color RAL 0001500 Black R10B (NN)	75,80		6	11	1,00	11,00	42	42,00	487,00
K53058280001VTE0	2.5x2.5 Color RAL 5002 Cobalt Blue R10B (NN)	77,00		6	11	1,00	11,00	42	42,00	487,00

2.5x2.5 R10A

K54053380001VTE0	2.5x2.5 Color RAL 0007500 Greige R10A (NN)	59,90		6	11	1,00	11,00	42	42,00	487,00
K54056680001VTE0	2.5x2.5 Color RAL 0808060 Yellow R10A (NN)	67,75		6	11	1,00	11,00	42	42,00	487,00
K54054480001VTE0	2.5x2.5 Color RAL 0001500 Black R10A (NN)	75,80		6	11	1,00	11,00	42	42,00	487,00

2.5x2.5 Matt

K52758380001VTE0	2.5x2.5 Color RAL 1009005 Ultra White Matt (NN)	50,75		6	11	1,00	11,00	42	42,00	487,00
K02775180001VTE0	2.5x2.5 Color RAL 0809005 Cream Matt (NN)	50,75		6	11	1,00	11,00	42	42,00	487,00
K02779580001VTE0	2.5x2.5 Color RAL 0958010 Light Mink Matt (NN)	50,75		6	11	1,00	11,00	42	42,00	487,00
K52757280001VTE0	2.5x2.5 Color RAL 0808010 Sand Matt (NN)	50,75		6	11	1,00	11,00	42	42,00	487,00
K02789180001VTE0	2.5x2.5 Color RAL 2307015 Pool Blue Matt (NN)	50,75		6	11	1,00	11,00	42	42,00	487,00
K02768180001VTE0	2.5x2.5 Color RAL 7047 Light Grey Matt (NN)	49,50		6	11	1,00	11,00	42	42,00	487,00
K02770380001VTE0	2.5x2.5 Color RAL 9016 White Matt (NN)	49,50		6	11	1,00	11,00	42	42,00	487,00
K02767080001VTE0	2.5x2.5 Color RAL 0007500 Greige Matt (NN)	54,50		6	11	1,00	11,00	42	42,00	487,00
K54222480001VTE0	2.5x2.5 Color RAL 1008080 Lime Green Matt (NN)	55,75		6	11	1,00	11,00	42	42,00	487,00

Product Code Ürün kodu	Product Name Ürün adı	Euro		Thickness (mm) Kalınlık (mm)	Box Kutu		Pallet Palet	
		m ²	Pcs Ad.		Pcs Ad.	m ²	kg	Box Kutu

K53361480001VTE0	2.5x2.5 Color RAL 0008000 Grey Matt (NN)	54,50		6	11	1,00	11,00	42	42,00	487,00
K54223580001VTE0	2.5x2.5 Color RAL 1105050 Green Matt (NN)	55,75		6	11	1,00	11,00	42	42,00	487,00
K54194480001VTE0	2.5x2.5 Color RAL 2006020 Turquoise Matt (NN)	55,75		6	11	1,00	11,00	42	42,00	487,00
K02788080001VTE0	2.5x2.5 Color RAL 2008020 Calipso Matt (NN)	55,75		6	11	1,00	11,00	42	42,00	487,00
K02793580001VTE0	2.5x2.5 Color RAL 2606030 Cool Blue Matt (NN)	55,75		6	11	1,00	11,00	42	42,00	487,00
K53530580001VTE0	2.5x2.5 Color RAL 2306020 Blue Matt (NN)	55,75		6	11	1,00	11,00	42	42,00	487,00
K02900080001VTE0	2.5x2.5 Color RAL 0005500 Dark Grey Matt (NN)	59,90		6	11	1,00	11,00	42	42,00	487,00
K53371080001VTE0	2.5x2.5 Color RAL 0808060 Yellow Matt (NN)	61,25		6	11	1,00	11,00	42	42,00	487,00
K54193380001VTE0	2.5x2.5 Color RAL 2404020 Ocean Blue Matt (NN)	61,25		6	11	1,00	11,00	42	42,00	487,00
K51714280001VTE0	2.5x2.5 Color RAL 2603035 Aqua Blue Matt (NN)	61,25		6	11	1,00	11,00	42	42,00	487,00
K53527280001VTE0	2.5x2.5 Color RAL 2004030 Dark Turquoise Matt (NN)	61,25		6	11	1,00	11,00	42	42,00	487,00
K53524680001VTE0	2.5x2.5 Color RAL 0757070 Dark Yellow Matt (NN)	61,25		6	11	1,00	11,00	42	42,00	487,00
K52046580001VTE0	2.5x2.5 Color RAL 2003 Orange Matt (NN)	61,25		6	11	1,00	11,00	42	42,00	487,00
K02765580001VTE0	2.5x2.5 Color RAL 0001500 Black Matt (NN)	68,90		6	11	1,00	11,00	42	42,00	487,00
K51548480001VTE0	2.5x2.5 Color RAL 0004000 Anthracite Matt (NN)	68,90		6	11	1,00	11,00	42	42,00	487,00
K02950180001VTE0	2.5x2.5 Color RAL 3004 Burgundy Matt (NN)	70,25		6	11	1,00	11,00	42	42,00	487,00
K02764480001VTE0	2.5x2.5 Color RAL 5002 Cobalt Blue Matt (NN)	70,25		6	11	1,00	11,00	42	42,00	487,00
K52679180001VTE0	2.5x2.5 Color RAL 0304050 Red Matt (NN)	84,00		6	11	1,00	11,00	42	42,00	487,00

5x5 Glossy

K53464280001VTE0	5x5 Color RAL 1009005 Ultra White Glossy (NN)	35,00		6	11	1,00	11,75	78	78,00	941,50
K02821580001VTE0	5x5 Color RAL 0809005 Cream Glossy (NN)	35,00		6	11	1,00	11,75	78	78,00	941,50
K50847080001VTE0	5x5 Color RAL 0809010 Light Sand Glossy (NN)	35,00		6	11	1,00	11,75	78	78,00	941,50
K50715080001VTE0	5x5 Color RAL 0958010 Light Mink Glossy (NN)	35,00		6	11	1,00	11,75	78	78,00	941,50
K50564380001VTE0	5x5 Color RAL 2307015 Pool Blue Glossy (NN)	35,00		6	11	1,00	11,75	78	78,00	941,50
K50561080001VTE0	5x5 Color RAL 7047 Light Grey Glossy (NN)	33,70		6	11	1,00	11,75	78	78,00	941,50
K50560680001VTE0	5x5 Color RAL 9016 White Glossy (NN)	33,70		6	11	1,00	11,75	78	78,00	941,50
K94641580001VTE0	5x5 Color Basic Mi5 Glossy (NN)	38,25		6	11	1,00	11,75	78	78,00	941,50
K53410480001VTE0	5x5 Color RAL 0007500 Greige Glossy (NN)	37,10		6	11	1,00	11,75	78	78,00	941,50
K54228380001VTE0	5x5 Color RAL 1008080 Lime Green Glossy (NN)	38,25		6	11	1,00	11,75	78	78,00	941,50
K54229480001VTE0	5x5 Color RAL 1105050 Green Glossy (NN)	38,25		6	11	1,00	11,75	78	78,00	941,50
K54200380001VTE0	5x5 Color RAL 2006020 Turquoise Glossy (NN)	38,25		6	11	1,00	11,75	78	78,00	941,50
K02829680001VTE0	5x5 Color RAL 2008020 Calipso Glossy (NN)	38,25		6	11	1,00	11,75	78	78,00	941,50
K50656480001VTE0	5x5 Color RAL 2606030 Cool Blue Glossy (NN)	38,25		6	11	1,00	11,75	78	78,00	941,50
K51575380001VTE0	5x5 Color RAL 0005500 Dark Grey Glossy (NN)	40,80		6	11	1,00	11,75	78	78,00	941,50
K50495480001VTE0	5x5 Color RAL 1018 Yellow Glossy (NN)	42,00		6	11	1,00	11,75	78	78,00	941,50
K54199280001VTE0	5x5 Color RAL 2404020 Ocean Blue Glossy (NN)	42,00		6	11	1,00	11,75	78	78,00	941,50
K50851480001VTE0	5x5 Color RAL 2603035 Aqua Blue Glossy (NN)	42,00		6	11	1,00	11,75	78	78,00	941,50
K50565480001VTE0	5x5 Color RAL 0001500 Black Glossy (NN)	46,90		6	11	1,00	11,75	78	78,00	941,50
K50908580001VTE0	5x5 Color RAL 0004000 Anthracite Glossy (NN)	46,90		6	11	1,00	11,75	78	78,00	941,50
K52946280001VTE0	5x5 Color RAL 2010 Orange Glossy (NN)	48,25		6	11	1,00	11,75	78	78,00	941,50
K50682280001VTE0	5x5 Color RAL 3004 Burgundy Glossy (NN)	48,25		6	11	1,00	11,75	78	78,00	941,50
K50563280001VTE0	5x5 Color RAL 5002 Cobalt Blue Glossy (NN)	48,25		6	11	1,00	11,75	78	78,00	941,50
K52643080001VTE0	5x5 Color RAL 3000 Red Glossy (NN)	57,50		6	11	1,00	11,75	78	78,00	941,50

Color

Product Code Ürün kodu	Product Name Ürün adı	Euro		Thickness (mm) Kalınlık (mm)	Box Kutu		Pallet Palet		
		m ²	Pcs Ad.		Pcs Ad.	m ²	kg	Box Kutu	m ²

5x5 R10B

K51162280001VTE0	5x5 Color RAL 0809005 Cream R10B (NN)	33,50		6	11	1,00	11,75	78	78,00	941,50
K53413080001VTE0	5x5 Color RAL 0809010 Light Sand R10B (NN)	33,50		6	11	1,00	11,75	78	78,00	941,50
K50502480001VTE0	5x5 Color RAL 2307015 Pool Blue R10B (NN)	33,50		6	11	1,00	11,75	78	78,00	941,50
K50501380001VTE0	5x5 Color RAL 7047 Light Grey R10B (NN)	32,20		6	11	1,00	11,75	78	78,00	941,50
K50500280001VTE0	5x5 Color RAL 9016 White R10B (NN)	32,20		6	11	1,00	11,75	78	78,00	941,50
K50503580001VTE0	5x5 Color RAL 0007500 Greige R10B (NN)	35,40		6	11	1,00	11,75	78	78,00	941,50
K50504680001VTE0	5x5 Color RAL 0005500 Dark Grey R10B (NN)	39,00		6	11	1,00	11,75	78	78,00	941,50
K52360480001VTE0	5x5 Color RAL 0001500 Black R10B (NN)	44,80		6	11	1,00	11,75	78	78,00	941,50
K53540180001VTE0	5x5 Color RAL 0004000 Anthracite R10B (NN)	44,80		6	11	1,00	11,75	78	78,00	941,50
K51027680001VTE0	5x5 Color RAL 5002 Cobalt Blue R10B (NN)	46,00		6	11	1,00	11,75	78	78,00	941,50

5x5 Matt

K52764280001VTE0	5x5 Color RAL 1009005 Ultra White Matt (NN)	30,50		6	11	1,00	11,75	78	78,00	941,50
K50611180001VTE0	5x5 Color RAL 0809005 Cream Matt (NN)	30,50		6	11	1,00	11,75	78	78,00	941,50
K50584280001VTE0	5x5 Color RAL 0809010 Light Sand Matt (NN)	30,50		6	11	1,00	11,75	78	78,00	941,50
K50494380001VTE0	5x5 Color RAL 0958010 Light Mink Matt (NN)	30,50		6	11	1,00	11,75	78	78,00	941,50
K52763180001VTE0	5x5 Color RAL 0808010 Sand Matt (NN)	30,50		6	11	1,00	11,75	78	78,00	941,50
K50497680001VTE0	5x5 Color RAL 2307015 Pool Blue Matt (NN)	30,50		6	11	1,00	11,75	78	78,00	941,50
K50489580001VTE0	5x5 Color RAL 7047 Light Grey Matt (NN)	29,30		6	11	1,00	11,75	78	78,00	941,50
K50488480001VTE0	5x5 Color RAL 9016 White Matt (NN)	29,30		6	11	1,00	11,75	78	78,00	941,50
K94641780001VTE0	5x5 Color Neutral Mi5 Matt (NN)	33,50		6	11	1,00	11,75	78	78,00	941,50
K50491080001VTE0	5x5 Color RAL 0007500 Greige Matt (NN)	32,20		6	11	1,00	11,75	78	78,00	941,50
K54226180001VTE0	5x5 Color RAL 1008080 Lime Green Matt (NN)	33,50		6	11	1,00	11,75	78	78,00	941,50
K53391680001VTE0	5x5 Color RAL 0008000 Grey Matt (NN)	32,20		6	11	1,00	11,75	78	78,00	941,50
K54227280001VTE0	5x5 Color RAL 1105050 Green Matt (NN)	33,50		6	11	1,00	11,75	78	78,00	941,50
K54198180001VTE0	5x5 Color RAL 2006020 Turquoise Matt (NN)	33,50		6	11	1,00	11,75	78	78,00	941,50
K50594580001VTE0	5x5 Color RAL 2008020 Calipso Matt (NN)	33,50		6	11	1,00	11,75	78	78,00	941,50
K50492180001VTE0	5x5 Color RAL 2606030 Cool Blue Matt (NN)	33,50		6	11	1,00	11,75	78	78,00	941,50
K94695880001VTE0	5x5 RAL 2306020 Blue Matt (NN)	33,50		6	11	1,00	11,75	78	78,00	941,50
K94695980001VTE0	5x5 RAL 0806005 Dark Greige Matt (NN)	33,50		6	11	1,00	11,75	78	78,00	941,50
K94696080001VTE0	5x5 RAL 0505010 Mink Matt (NN)	33,50		6	11	1,00	11,75	78	78,00	941,50
K94696680001VTE0	5x5 RAL 0606020 Soft Brown Matt (NN)	33,50		6	11	1,00	11,75	78	78,00	941,50
K94696780001VTE0	5x5 RAL 0206005 Whisper Lilac Matt (NN)	33,50		6	11	1,00	11,75	78	78,00	941,50
K94696880001VTE0	5x5 RAL 1007010 Light Khaki Matt (NN)	33,50		6	11	1,00	11,75	78	78,00	941,50
K50493280001VTE0	5x5 Color RAL 0005500 Dark Grey Matt (NN)	35,40		6	11	1,00	11,75	78	78,00	941,50
K53400180001VTE0	5x5 Color RAL 0808060 Yellow Matt (NN)	36,75		6	11	1,00	11,75	78	78,00	941,50
K54197080001VTE0	5x5 Color RAL 2404020 Ocean Blue Matt (NN)	36,75		6	11	1,00	11,75	78	78,00	941,50
K50597180001VTE0	5x5 Color RAL 2603035 Aqua Blue Matt (NN)	36,75		6	11	1,00	11,75	78	78,00	941,50
K94695780001VTE0	5x5 RAL 2004030 Dark Turquoise Matt (NN)	36,75		6	11	1,00	11,75	78	78,00	941,50
K94697080001VTE0	5x5 RAL 0757070 Dark Yellow Matt (NN)	36,75		6	11	1,00	11,75	78	78,00	941,50
K94695680001VTE0	5x5 RAL 2003 Orange Matt (NN)	36,75		6	11	1,00	11,75	78	78,00	941,50
K94696280001VTE0	5x5 RAL 0504040 Tobacco Matt (NN)	36,75		6	11	1,00	11,75	78	78,00	941,50
K94696380001VTE0	5x5 RAL 0706040 Ochre Yellow Matt (NN)	36,75		6	11	1,00	11,75	78	78,00	941,50
K94696580001VTE0	5x5 RAL 0404005 Basalt Brown Matt (NN)	36,75		6	11	1,00	11,75	78	78,00	941,50

Product Code Ürün kodu	Product Name Ürün adı	Euro		Thickness (mm) Kalınlık (mm)	Box Kutu			Pallet Palet		
		m ²	Pcs Ad.		Pcs Ad.	m ²	kg	Box Kutu	m ²	kg
K94696980001VTE0	5x5 RAL 2205005 Prussian Blue Matt (NN)	36,75		6	11	1,00	11,75	78	78,00	941,50
K50498080001VTE0	5x5 Color RAL 0001500 Black Matt (NN)	40,80		6	11	1,00	11,75	78	78,00	941,50
K52443380001VTE0	5x5 Color RAL 0004000 Anthracite Matt (NN)	40,80		6	11	1,00	11,75	78	78,00	941,50
K50574680001VTE0	5x5 RAL 3004 Burgundy Matt (NN)	42,00		6	11	1,00	11,75	78	78,00	941,50
K50490680001VTE0	5x5 Color RAL 5002 Cobalt Blue Matt (NN)	42,00		6	11	1,00	11,30	78	78,00	906,40
K94696480001VTE0	5x5 RAL 2904015 Plum Matt (NN)	42,00		6	11	1,00	11,75	78	78,00	941,50
K52681380001VTE0	5x5 Color RAL 0304050 Red Matt (NN)	50,25		6	11	1,00	11,75	78	78,00	941,50
10x10 Glossy										
K53453580001VTE0	10x10 Color RAL 1009005 Ultra White Glossy (NN)	21,75		6	11	1,00	12,50	78	78,00	1.000,00
K50647280001VTE0	10x10 Color RAL 0809005 Cream Glossy (NN)	21,75		6	11	1,00	12,50	78	78,00	1.000,00
K50648380001VTE0	10x10 Color RAL 0809010 Light Sand Glossy (NN)	21,75		6	11	1,00	12,50	78	78,00	1.000,00
K50956580001VTE0	10x10 Color RAL 0958010 Light Mink Glossy (NN)	21,75		6	11	1,00	12,50	78	78,00	1.000,00
K50534180001VTE0	10x10 Color RAL 2307015 Pool Blue Glossy (NN)	21,75		6	11	1,00	12,50	78	78,00	1.000,00
K50401180001VTE0	10x10 Color RAL 7047 Light Grey Glossy (NN)	20,50		6	11	1,00	12,50	78	78,00	1.000,00
K50382380001VTE0	10x10 Color RAL 9016 White Glossy (NN)	20,50		6	11	1,00	12,50	78	78,00	1.000,00
K51142380001VTE0	10x10 Color RAL 0007500 Greige Glossy (NN)	22,50		6	11	1,00	12,50	78	78,00	1.000,00
K54232080001VTE0	10x10 Color RAL 1008080 Lime Green Glossy (NN)	23,75		6	11	1,00	12,50	78	78,00	1.000,00
K54233180001VTE0	10x10 Color RAL 1105050 Green Glossy (NN)	23,75		6	11	1,00	12,50	78	78,00	1.000,00
K50655380001VTE0	10x10 Color RAL 2008020 Calipso Glossy (NN)	23,75		6	11	1,00	12,50	78	78,00	1.000,00
K50654280001VTE0	10x10 Color RAL 2606030 Cool Blue Glossy (NN)	23,75		6	11	1,00	12,50	78	78,00	1.000,00
K50733480001VTE0	10x10 Color RAL 0005500 Dark Grey Glossy (NN)	22,50		6	11	1,00	12,50	78	78,00	1.000,00
K50824480001VTE0	10x10 Color RAL 1018 Yellow Glossy (NN)	23,75		6	11	1,00	12,50	78	78,00	1.000,00
K94776380001VTE0	10x10 Color RAL 2603035 Aqua Blue Glossy (NN)	23,75		6	11	1,00	12,50	78	78,00	1.000,00
K53411580001VTE0	10x10 Color RAL 2004030 Dark Turquoise Glossy (NN)	23,75		6	11	1,00	12,50	78	78,00	1.000,00
K53452480001VTE0	10x10 Color RAL 0757070 Dark Yellow Glossy (NN)	23,75		6	11	1,00	12,50	78	78,00	1.000,00
K50535280001VTE0	10x10 Color RAL 0001500 Black Glossy (NN)	28,50		6	11	1,00	12,50	78	78,00	1.000,00
K52051380001VTE0	10x10 Color RAL 0004000 Anthracite Glossy (NN)	28,50		6	11	1,00	12,50	78	78,00	1.000,00
K53451380001VTE0	10x10 Color RAL 2010 Orange Glossy (NN)	29,75		6	11	1,00	12,50	78	78,00	1.000,00
K50533080001VTE0	10x10 Color RAL 5002 Cobalt Blue Glossy (NN)	29,75		6	11	1,00	12,50	78	78,00	1.000,00
K52644180001VTE0	10x10 Color RAL 3000 Red Glossy (NN)	35,25		6	11	1,00	12,50	78	78,00	1.000,00
10x10 R10B										
K53456180001VTE0	10x10 Color RAL 0809010 Light Sand R10B (NN)	20,75		6	11	1,00	12,50	78	78,00	1.000,00
K94776480001VTE0	10x10 Color RAL 2307015 Pool Blue R10B (NN)	20,75		6	11	1,00	12,50	78	78,00	1.000,00
K94776280001VTE0	10x10 Color RAL 7047 Light Grey R10B (NN)	19,60		6	11	1,00	12,50	78	78,00	1.000,00
K94776080001VTE0	10x10 Color RAL 9016 White R10B (NN)	19,60		6	11	1,00	12,50	78	78,00	1.000,00
K94776180001VTE0	10x10 Color RAL 0007500 Greige R10B (NN)	21,50		6	11	1,00	12,50	78	78,00	1.000,00
K50300580001VTE0	10x10 Color RAL 0005500 Dark Grey R10B (NN)	23,70		6	11	1,00	12,50	78	78,00	1.000,00
K54166080001VTE0	10x10 Color RAL 2603035 Aqua Blue R10B (NN)	25,00		6	11	1,00	12,50	78	78,00	1.000,00
K51267380001VTE0	10x10 Color RAL 0001500 Black R10B (NN)	27,20		6	11	1,00	12,50	78	78,00	1.000,00
K53542380001VTE0	10x10 Color RAL 0004000 Anthracite R10B (NN)	27,20		6	11	1,00	12,50	78	78,00	1.000,00
K53455080001VTE0	10x10 Color RAL 5002 Cobalt Blue R10B (NN)	28,50		6	11	1,00	12,50	78	78,00	1.000,00
10x10 R10A										
K51878580001VTE0	10x10 Color RAL 9016 White R10A (NN)	19,60		6	11	1,00	12,50	78	78,00	1.000,00
K51879680001VTE0	10x10 Color RAL 0007500 Greige R10A (NN)	21,50		6	11	1,00	12,50	78	78,00	1.000,00

Color

Product Code Ürün kodu	Product Name Ürün adı	Euro		Thickness (mm) Kalınlık (mm)	Box Kutu		Pallet Palet		
		m ²	Pcs Ad.		Pcs Ad.	m ²	kg	Box Kutu	m ²

10x10 R9

K51840280001VTE0	10x10 Color RAL 9016 White R9 (NN)	19,60		6	11	1,00	12,50	78	78,00	1.000,00
K51842480001VTE0	10x10 Color RAL 0007500 Greige R9 (NN)	19,60		6	11	1,00	12,50	78	78,00	1.000,00

10x10 C

K53459480001VTE0	10x10 Color RAL 7047 Light Grey C (NN)	19,60		6	11	1,00	12,50	78	78,00	1.000,00
K53458380001VTE0	10x10 Color RAL 9016 White C (NN)	19,60		6	11	1,00	12,50	78	78,00	1.000,00
K54165880001VTE0	10x10 Color RAL 2606030 Cool Blue C (NN)	22,75		6	11	1,00	12,50	78	78,00	1.000,00
K54165980001VTE0	10x10 Color RAL 2603035 Aqua Blue C (NN)	25,00		6	11	1,00	12,50	78	78,00	1.000,00
K53460580001VTE0	10x10 Color RAL 0001500 Black C (NN)	27,20		6	11	1,00	12,50	78	78,00	1.000,00
K53015180001VTE0	10x10 Color RAL 5002 Cobalt Blue C (NN)	28,50		6	11	1,00	12,50	78	78,00	1.000,00

10x10 Matt

K52770180001VTE0	10x10 Color RAL 1009005 Ultra White Matt (NN)	19,00		6	11	1,00	12,50	78	78,00	1.000,00
K50612280001VTE0	10x10 Color RAL 0809005 Cream Matt (NN)	19,00		6	11	1,00	12,50	78	78,00	1.000,00
K50528280001VTE0	10x10 Color RAL 0809010 Light Sand Matt (NN)	19,00		6	11	1,00	12,50	78	78,00	1.000,00
K54207380001VTE0	10x10 Color RAL 0958010 Light Mink Matt (NN)	19,00		6	11	1,00	12,50	78	78,00	1.000,00
K52769080001VTE0	10x10 Color RAL 0808010 Sand Matt (NN)	19,00		6	11	1,00	12,50	78	78,00	1.000,00
K94835880001VTE0	10x10 Color RAL 2307015 Pool Blue Matt (NN)	19,00		6	11	1,00	12,50	78	78,00	1.000,00
K50793180001VTE0	10x10 Color RAL 7047 Light Grey Matt (NN)	17,80		6	11	1,00	12,50	78	78,00	1.000,00
K50792080001VTE0	10x10 Color RAL 9016 White Matt (NN)	17,80		6	11	1,00	12,50	78	78,00	1.000,00
K50798680001VTE0	10x10 Color RAL 0007500 Greige Matt (NN)	19,60		6	11	1,00	12,50	78	78,00	1.000,00
K54230580001VTE0	10x10 Color RAL 1008080 Lime Green Matt (NN)	20,75		6	11	1,00	12,50	78	78,00	1.000,00
K53419680001VTE0	10x10 Color RAL 0008000 Grey Matt (NN)	19,60		6	11	1,00	12,50	78	78,00	1.000,00
K54231680001VTE0	10x10 Color RAL 1105050 Green Matt (NN)	20,75		6	11	1,00	12,50	78	78,00	1.000,00
K54202580001VTE0	10x10 Color RAL 2006020 Turquoise Matt (NN)	20,75		6	11	1,00	12,50	78	78,00	1.000,00
K50205180001VTE0	10x10 Color RAL 2008020 Calipso Matt (NN)	20,75		6	11	1,00	12,50	78	78,00	1.000,00
K50206280001VTE0	10x10 Color RAL 2606030 Cool Blue Matt (NN)	20,75		6	11	1,00	12,50	78	78,00	1.000,00
K53447680001VTE0	10x10 Color RAL 2306020 Blue Matt (NN)	20,75		6	11	1,00	12,50	78	78,00	1.000,00
K54208480001VTE0	10x10 Color RAL 0806005 Dark Greige Matt (NN)	20,75		6	11	1,00	12,50	78	78,00	1.000,00
K54209580001VTE0	10x10 Color RAL 0505010 Mink Matt (NN)	20,75		6	11	1,00	12,50	78	78,00	1.000,00
K54166480001VTE0	10x10 Color RAL 0606020 Soft Brown Matt (NN)	20,75		6	11	1,00	12,50	78	78,00	1.000,00
K54171280001VTE0	10x10 Color RAL 0206005 Whisper Lilac Matt (NN)	20,75		6	11	1,00	12,50	78	78,00	1.000,00
K54172380001VTE0	10x10 Color RAL 1007010 Light Khaki Matt (NN)	20,75		6	11	1,00	12,50	78	78,00	1.000,00
K94641880001VTE0	10x10 Color Mood Mi5 Matt (NN)	20,75		6	11	1,00	12,50	78	78,00	1.000,00
K94641680001VTE0	10x10 Color Aqua Mi5 Matt (NN)	20,75		6	11	1,00	12,50	78	78,00	1.000,00
K50794280001VTE0	10x10 Color RAL 0005500 Dark Grey Matt (NN)	21,50		6	11	1,00	12,50	78	78,00	1.000,00
K53437380001VTE0	10x10 Color RAL 0808060 Yellow Matt (NN)	22,75		6	11	1,00	12,50	78	78,00	1.000,00
K54201480001VTE0	10x10 Color RAL 2404020 Ocean Blue Matt (NN)	22,75		6	11	1,00	12,50	78	78,00	1.000,00
K53465380001VTE0	10x10 Color RAL 2603035 Aqua Blue Matt (NN)	22,75		6	11	1,00	12,50	78	78,00	1.000,00
K53445480001VTE0	10x10 Color RAL 2004030 Dark Turquoise Matt (NN)	22,75		6	11	1,00	12,50	78	78,00	1.000,00
K53433680001VTE0	10x10 Color RAL 0757070 Dark Yellow Matt (NN)	22,75		6	11	1,00	12,50	78	78,00	1.000,00
K52997480001VTE0	10x10 Color RAL 2003 Orange Matt (NN)	22,75		6	11	1,00	12,50	78	78,00	1.000,00
K54165380001VTE0	10x10 Color RAL 0504040 Tobacco Matt (NN)	22,75		6	11	1,00	12,50	78	78,00	1.000,00
K54168680001VTE0	10x10 Color RAL 0706040 Ochre Yellow Matt (NN)	22,75		6	11	1,00	12,50	78	78,00	1.000,00
K54170180001VTE0	10x10 Color RAL 0404005 Basalt Brown Matt (NN)	22,75		6	11	1,00	12,50	78	78,00	1.000,00

Product Code Ürün kodu	Product Name Ürün adı	Euro		Thickness (mm) Kalınlık (mm)	Box Kutu			Pallet Palet		
		m ²	Pcs Ad.		Pcs Ad.	m ²	kg	Box Kutu	m ²	kg
K54167580001VTE0	10x10 Color RAL 2205005 Prussian Blue Matt (NN)	22,75		6	11	1,00	12,50	78	78,00	1.000,00
K50797580001VTE0	10x10 Color RAL 0001500 Black Matt (NN)	24,70		6	11	1,00	12,50	78	78,00	1.000,00
K50790580001VTE0	10x10 Color RAL 0004000 Anthracite Matt (NN)	24,70		6	11	1,00	12,50	78	78,00	1.000,00
K50816380001VTE0	10x10 Color RAL 3004 Burgundy Matt (NN)	26,00		6	11	1,00	12,50	78	78,00	1.000,00
K50796480001VTE0	10x10 Color RAL 5002 Cobalt Blue Matt (NN)	26,00		6	11	1,00	12,50	78	78,00	1.000,00
K54169080001VTE0	10x10 Color RAL 2904015 Plum Matt (NN)	26,00		6	11	1,00	12,50	78	78,00	1.000,00
K53420080001VTE0	10x10 Color RAL 0304050 Red Matt (NN)	31,00		6	11	1,00	12,50	78	78,00	1.000,00
K5079208C001VTE0	10x10 Color RAL 9016 White Matt Clean (NN)	22,90		6	11	1,00	12,50	78	78,00	1.000,00
K5079208S001VTE0	10x10 Color RAL 9016 White Matt Shield (NN)	23,90		6	11	1,00	12,50	78	78,00	1.000,00
10x20 Glossy										
K76635600001VTE0	10x20 Color RAL 9016 White Glossy	20,70		6	50	1,00	12,70	84	84,00	1.091,80
K85300200001VTE0	10x20 Color RAL 7047 Light Grey Glossy	20,70		6	50	1,00	12,70	84	84,00	1.091,80
K53802400001VTE0	10x20 Color RAL 0958010 Light Mink Glossy	20,70		6	50	1,00	12,70	84	84,00	1.091,80
K77908500001VTE0	10x20 Color RAL 0809010 Light Sand Glossy	20,70		6	50	1,00	12,70	84	84,00	1.091,80
K77013600001VTE0	10x20 Color RAL 2307015 Pool Blue Glossy	20,70		6	50	1,00	12,70	84	84,00	1.091,80
K89101100001VTE0	10x20 Color RAL 0007500 Greige Glossy	22,80		6	50	1,00	12,70	84	84,00	1.091,80
K77634400001VTE0	10x20 Color RAL 2606030 Cool Blue Glossy	22,80		6	50	1,00	12,70	84	84,00	1.091,80
K89100000001VTE0	10x20 Color RAL 0005500 Dark Grey Glossy	25,10		6	50	1,00	12,70	84	84,00	1.091,80
K50283200001VTE0	10x20 Color RAL 2603035 Aqua Blue Glossy	25,10		6	50	1,00	12,70	84	84,00	1.091,80
K77636600001VTE0	10x20 Color RAL 5002 Cobalt Blue Glossy	28,90		6	50	1,00	12,70	84	84,00	1.091,80
K77635500001VTE0	10x20 Color RAL 0001500 Black Glossy	28,90		6	50	1,00	12,70	84	84,00	1.091,80
K52645200001VTE0	10x20 Color RAL 3000 Red Glossy	34,60		6	50	1,00	12,70	84	84,00	1.091,80
10x20 Matt										
K50079100001VTE0	10x20 Color RAL 9016 White Matt	18,00		6	50	1,00	12,70	84	84,00	1.091,80
K89096300001VTE0	10x20 Color RAL 1009005 Ultra White Matt	18,00		6	50	1,00	12,70	84	84,00	1.091,80
K50237500001VTE0	10x20 Color RAL 7047 Light Grey Matt	18,00		6	50	1,00	12,70	84	84,00	1.091,80
K54210600001VTE0	10x20 Color RAL 0958010 Light Mink Matt	18,00		6	50	1,00	12,70	84	84,00	1.091,80
K86720600001VTE0	10x20 Color RAL 0809005 Cream Matt	18,00		6	50	1,00	12,70	84	84,00	1.091,80
K50080200001VTE0	10x20 Color RAL 2307015 Pool Blue Matt	18,00		6	50	1,00	12,70	84	84,00	1.091,80
K50232000001VTE0	10x20 Color RAL 0007500 Greige Matt	19,80		6	50	1,00	12,70	84	84,00	1.091,80
K54211000001VTE0	10x20 Color RAL 0806005 Dark Greige Matt	19,80		6	50	1,00	12,70	84	84,00	1.091,80
K54212100001VTE0	10x20 Color RAL 0505010 Mink Matt	19,80		6	50	1,00	12,70	84	84,00	1.091,80
K54236400001VTE0	10x20 Color RAL 1105050 Green Matt	19,80		6	50	1,00	12,70	84	84,00	1.091,80
K54235300001VTE0	10x20 Color RAL 1008080 Lime Green Matt	19,80		6	50	1,00	12,70	84	84,00	1.091,80
K50281000001VTE0	10x20 Color RAL 2606030 Cool Blue Matt	19,80		6	50	1,00	12,70	84	84,00	1.091,80
K54204000001VTE0	10x20 Color RAL 2006020 Turquoise Matt	19,80		6	50	1,00	12,70	84	84,00	1.091,80
K50280600001VTE0	10x20 Color RAL 2008020 Calipso Matt	19,80		6	50	1,00	12,70	84	84,00	1.091,80
K94773400001VTE0	10x20 Color RAL 0008000 Grey Matt	19,80		6	50	1,00	12,70	84	84,00	1.091,80
K50272500001VTE0	10x20 Color RAL 0005500 Dark Grey Matt	21,80		6	50	1,00	12,70	84	84,00	1.091,80
K54234200001VTE0	10x20 Color RAL 2003 Orange Matt	21,80		6	50	1,00	12,70	84	84,00	1.091,80
K54203600001VTE0	10x20 Color RAL 2404020 Ocean Blue Matt	21,80		6	50	1,00	12,70	84	84,00	1.091,80
K50069500001VTE0	10x20 Color RAL 5002 Cobalt Blue Matt	25,10		6	50	1,00	12,70	84	84,00	1.091,80
K50068400001VTE0	10x20 Color RAL 0001500 Black Matt	25,10		6	50	1,00	12,70	84	84,00	1.091,80

Color

Product Code Ürün kodu	Product Name Ürün adı	Euro		Thickness (mm) Kalınlık (mm)	Box Kutu		Pallet Palet		
		m ²	Pcs Ad.		Pcs Ad.	m ²	kg	Box Kutu	m ²

10x20 R10B

K50086100001VTE0	10x20 Color RAL 9016 White R10B	19,80		6	50	1,00	12,70	84	84,00	1.091,80
K50287600001VTE0	10x20 Color RAL 7047 Light Grey R10B	19,80		6	50	1,00	12,70	84	84,00	1.091,80
K50081300001VTE0	10x20 Color RAL 2307015 Pool Blue R10B	19,80		6	50	1,00	12,70	84	84,00	1.091,80
K51068600001VTE0	10x20 Color RAL 2606030 Cool Blue R10B	21,80		6	50	1,00	12,70	84	84,00	1.091,80
K77220100001VTE0	10x20 Color RAL 5002 Cobalt Blue R10B	27,60		6	50	1,00	12,70	84	84,00	1.091,80
K77221200001VTE0	10x20 Color RAL 0001500 Black R10B	27,60		6	50	1,00	12,70	84	84,00	1.091,80

10x20 C

K77222300001VTE0	10x20 Color RAL 9016 White C	19,80		6	50	1,00	12,70	84	84,00	1.091,80
K89105500001VTE0	10x20 Color RAL 7047 Light Grey C	19,80		6	50	1,00	12,70	84	84,00	1.091,80
K77223400001VTE0	10x20 Color RAL 2307015 Pool Blue C	19,80		6	50	1,00	12,70	84	84,00	1.091,80
K77224500001VTE0	10x20 Color RAL 5002 Cobalt Blue C	27,60		6	50	1,00	12,70	84	84,00	1.091,80

10x30 Glossy

K94341900001VTE0	10x30 Color RAL 9016 White Wall Glossy	21,30		7,5	33	1,00	11,95	77	77,00	945,15
K94421800001VTE0	10x30 Color RAL 1009005 Ultra White Wall Glossy	21,30		7,5	33	1,00	11,95	77	77,00	945,15
K94421900001VTE0	10x30 Color RAL 7047 Light Grey Wall Glossy	21,30		7,5	33	1,00	11,95	77	77,00	945,15
K94421700001VTE0	10x30 Color RAL 0958010 Light Mink Wall Glossy	21,30		7,5	33	1,00	11,95	77	77,00	945,15
K94422100001VTE0	10x30 Color RAL 0007500 Greige Wall Glossy	22,50		7,5	33	1,00	11,95	77	77,00	945,15
K79060500001VTE0	10x30 Color RAL 9016 White Glossy	22,90		6	33	1,00	14,10	72	72,00	1.040,20
K86155100001VTE0	10x30 Color RAL 1009005 Ultra White Glossy	22,90		6	33	1,00	12,60	72	72,00	932,20
K79423400001VTE0	10x30 Color RAL 7047 Light Grey Glossy	22,90		6	33	1,00	12,05	72	72,00	892,60
K79301100001VTE0	10x30 Color RAL 0958010 Light Mink Glossy	22,90		6	33	1,00	12,05	72	72,00	892,60
K88626200001VTE0	10x30 Color RAL 0809010 Light Sand Glossy	22,90		6	33	1,00	12,60	72	72,00	932,20
K81268100001VTE0	10x30 Color RAL 0809005 Cream Glossy	22,90		6	33	1,00	12,60	72	72,00	932,20
K79425600001VTE0	10x30 Color RAL 0007500 Greige Glossy	25,20		6	33	1,00	12,05	72	72,00	892,60
K54217600001VTE0	10x30 Color RAL 0806005 Dark Greige Glossy	25,20		6	33	1,00	12,60	72	72,00	932,20
K54218000001VTE0	10x30 Color RAL 0505010 Mink Glossy	25,20		6	33	1,00	12,05	72	72,00	892,60
K08615300001VTE0	10x30 Color RAL 1007010 Light Khaki Glossy	25,20		6	33	1,00	12,05	72	72,00	892,60
K08609400001VTE0	10x30 Color RAL 0606020 Soft Brown Glossy	25,20		6	33	1,00	12,60	72	72,00	932,20
K08614200001VTE0	10x30 Color RAL 0206005 Whisper Lilac Glossy	25,20		6	33	1,00	12,60	72	72,00	932,20
K54238600001VTE0	10x30 Color RAL 1105050 Green Glossy	25,20		6	33	1,00	12,05	72	72,00	892,60
K54237500001VTE0	10x30 Color RAL 1008080 Lime Green Glossy	25,20		6	33	1,00	12,05	72	72,00	892,60
K79424500001VTE0	10x30 Color RAL 0005500 Dark Grey Glossy	27,70		6	33	1,00	12,05	72	72,00	892,60
K08611600001VTE0	10x30 Color RAL 0706040 Ochre Yellow Glossy	27,70		6	33	1,00	12,60	72	72,00	932,20
K08613100001VTE0	10x30 Color RAL 0404005 Basalt Brown Glossy	27,70		6	33	1,00	12,60	72	72,00	932,20
K08608300001VTE0	10x30 Color RAL 0504040 Tobacco Glossy	27,70		6	33	1,00	12,60	72	72,00	932,20
K89136100001VTE0	10x30 Color RAL 2603035 Aqua Blue Glossy	27,70		6	33	1,00	12,60	72	72,00	932,20
K08610500001VTE0	10x30 Color RAL 2205005 Prussian Blue Glossy	27,70		6	33	1,00	12,05	72	72,00	892,60
K86037200001VTE0	10x30 Color RAL 2010 Orange Glossy	31,90		6	33	1,00	12,60	72	72,00	932,20
K08612000001VTE0	10x30 Color RAL 2904015 Plum Glossy	31,90		6	33	1,00	12,60	72	72,00	932,20
K79971100001VTE0	10x30 Color RAL 3004 Burgundy Glossy	31,90		6	33	1,00	12,60	72	72,00	932,20
K87665600001VTE0	10x30 Color RAL 5002 Cobalt Blue Glossy	31,90		6	33	1,00	12,05	72	72,00	892,60
K79426000001VTE0	10x30 Color RAL 0004000 Anthracite Glossy	31,90		6	33	1,00	12,05	72	72,00	892,60
K79421200001VTE0	10x30 Color RAL 0001500 Black Glossy	31,90		6	33	1,00	12,05	72	72,00	892,60

Product Code Ürün kodu	Product Name Ürün adı	Euro		Thickness (mm) Kalınlık (mm)	Box Kutu		Pallet Palet		m ²	kg
		m ²	Pcs Ad.		Pcs Ad.	m ²	kg	Box Kutu		
K87662300001VTE0	10x30 Color RAL 3000 Red Glossy	38,20		6	33	1,00	12,60	72	72,00	932,20
10x30 Matt										
K08607200001VTE0	10x30 Color RAL 9016 White Wall Matt	20,00		7,5	33	1,00	11,95	77	77,00	945,15
K94420900001VTE0	10x30 Color RAL 1009005 Ultra White Wall Matt	20,00		7,5	33	1,00	11,95	77	77,00	945,15
K94426900001VTE0	10x30 Color RAL 7047 Light Grey Wall Matt	20,00		7,5	33	1,00	11,95	77	77,00	945,15
K94420700001VTE0	10x30 Color RAL 0958010 Light Mink Wall Matt	20,00		7,5	33	1,00	11,95	77	77,00	945,15
K94418400001VTE0	10x30 Color RAL 0008000 Grey Wall Matt	20,00		7,5	33	1,00	11,95	77	77,00	945,15
K94421100001VTE0	10x30 Color RAL 0007500 Greige Wall Matt	22,00		7,5	33	1,00	11,95	77	77,00	945,15
K94421000001VTE0	10x30 Color RAL 0005500 Dark Grey Wall Matt	25,00		7,5	33	1,00	11,95	77	77,00	945,15
K94420800001VTE0	10x30 Color RAL 0001500 Black Wall Matt	28,00		7,5	33	1,00	11,95	77	77,00	945,15
K78512200001VTE0	10x30 Color RAL 9016 White Matt	19,90		6	33	1,00	12,05	72	72,00	892,60
K86154000001VTE0	10x30 Color RAL 1009005 Ultra White Matt	19,90		6	33	1,00	12,05	72	72,00	892,60
K79422300001VTE0	10x30 Color RAL 7047 Light Grey Matt	19,90		6	33	1,00	12,05	72	72,00	892,60
K54213200001VTE0	10x30 Color RAL 0958010 Light Mink Matt	19,90		6	33	1,00	12,05	72	72,00	892,60
K83808000001VTE0	10x30 Color RAL 0809010 Light Sand Matt	19,90		6	33	1,00	12,60	72	72,00	932,20
K80306000001VTE0	10x30 Color RAL 0809005 Cream Matt	19,90		6	33	1,00	12,05	72	72,00	892,60
K80575600001VTE0	10x30 Color RAL 2307015 Pool Blue Matt	19,90		6	33	1,00	12,60	72	72,00	932,20
K89113600001VTE0	10x30 Color RAL 0008000 Grey Matt	21,90		6	33	1,00	12,05	72	72,00	892,60
K79397600001VTE0	10x30 Color RAL 0007500 Greige Matt	21,90		6	33	1,00	12,05	72	72,00	892,60
K54214300001VTE0	10x30 Color RAL 0806005 Dark Greige Matt	21,90		6	33	1,00	12,60	72	72,00	932,20
K54215400001VTE0	10x30 Color RAL 0505010 Mink Matt	21,90		6	33	1,00	12,60	72	72,00	932,20
K79432600001VTE0	10x30 Color RAL 2606030 Cool Blue Matt	21,90		6	33	1,00	12,05	72	72,00	892,60
K89132400001VTE0	10x30 Color RAL 2008020 Calipso Matt	21,90		6	33	1,00	12,05	72	72,00	892,60
K78591400001VTE0	10x30 Color RAL 0005500 Dark Grey Matt	24,10		6	33	1,00	12,05	72	72,00	892,60
K89124300001VTE0	10x30 Color RAL 0808060 Yellow Matt	24,10		6	33	1,00	12,60	72	72,00	932,20
K86623000001VTE0	10x30 Color RAL 2603035 Aqua Blue Matt	24,10		6	33	1,00	12,60	72	72,00	932,20
K89108100001VTE0	10x30 Color RAL 5002 Cobalt Blue Matt	27,70		6	33	1,00	12,60	72	72,00	932,20
K79048000001VTE0	10x30 Color RAL 0004000 Anthracite Matt	27,70		6	33	1,00	12,05	72	72,00	892,60
K79059400001VTE0	10x30 Color RAL 0001500 Black Matt	27,70		6	33	1,00	12,05	72	72,00	892,60
K89114000001VTE0	10x30 Color RAL 0304050 Red Matt	33,20		6	33	1,00	12,05	72	72,00	892,60
K785122C0001VTE0	10x30 Color RAL 9016 White Matt Clean	25,00		6	33	1,00	12,60	72	72,00	932,20
K785122S0001VTE0	10x30 Color RAL 9016 White Matt Shield	26,00		6	33	1,00	12,10	72	72,00	896,20
12.5x25 Glossy										
K76210100001VTE0	12.5x25 Color RAL 9016 White Glossy	21,60		6,5	32	1,00	12,94	75	75,00	995,50
K76212300001VTE0	12.5x25 Color RAL 2307015 Pool Blue Glossy	21,60		6,5	32	1,00	12,94	75	75,00	995,50
K76502600001VTE0	12.5x25 Color RAL 5002 Cobalt Blue Glossy	30,10		6,5	32	1,00	12,94	75	75,00	995,50
K76451400001VTE0	12.5x25 Color RAL 0001500 Black Glossy	30,10		6,5	32	1,00	12,94	75	75,00	995,50
12.5x25 Matt										
K76209000001VTE0	12.5x25 Color RAL 9016 White Matt	18,80		6,5	32	1,00	12,94	75	75,00	995,50
K76211200001VTE0	12.5x25 Color RAL 2307015 Pool Blue Matt	18,80		6,5	32	1,00	12,94	75	75,00	995,50
K76501500001VTE0	12.5x25 Color RAL 5002 Cobalt Blue Matt	26,10		6,5	32	1,00	12,94	75	75,00	995,50
K76450300001VTE0	12.5x25 Color RAL 0001500 Black Matt	26,10		6,5	32	1,00	12,94	75	75,00	995,50

Color

Product Code Ürün kodu	Product Name Ürün adı	Euro		Thickness (mm) Kalınlık (mm)	Box Kutu		Pallet Palet		
		m ²	Pcs Ad.		Pcs Ad.	m ²	kg	Box Kutu	m ²

12.5x25 R10B

K77034600001VTE0	12.5x25 Color RAL 9016 White R10B	20,70		6,5	32	1,00	12,94	75	75,00	995,50
K77035000001VTE0	12.5x25 Color RAL 2307015 Pool Blue R10B	20,70		6,5	32	1,00	12,94	75	75,00	995,50
K77235200001VTE0	12.5x25 Color RAL 5002 Cobalt Blue R10B	28,70		6,5	32	1,00	12,94	75	75,00	995,50
K77236300001VTE0	12.5x25 Color RAL 0001500 Black R10B	28,70		6,5	32	1,00	12,94	75	75,00	995,50

12.5x25 C

K77238500001VTE0	12.5x25 Color RAL 9016 White C	20,70		6,5	32	1,00	12,94	75	75,00	995,50
K77240000001VTE0	12.5x25 Color RAL 2307015 Pool Blue C	20,70		6,5	32	1,00	12,94	75	75,00	995,50
K77237400001VTE0	12.5x25 Color RAL 5002 Cobalt Blue C	28,70		6,5	32	1,00	12,94	75	75,00	995,50
K77239600001VTE0	12.5x25 Color RAL 0001500 Black C	28,70		6,5	32	1,00	12,94	75	75,00	995,50

15x15 Glossy

K94777500001VTE0	15x15 Color RAL 9016 White Wall Glossy	15,30		6	44	1,00	9,50	100	100,00	975,00
K76797200001VTE0	15x15 Color RAL 9016 White Glossy	18,00		6	44	1,00	12,47	80	80,00	1.022,60
K78277400001VTE0	15x15 Color RAL 7047 Light Grey Glossy	18,00		6	44	1,00	12,47	80	80,00	1.022,60
K78278500001VTE0	15x15 Color RAL 0005500 Dark Grey Glossy	21,80		6	44	1,00	12,47	80	80,00	1.022,60
K75703300001VTE0	15x15 Color RAL 1018 Yellow Glossy	21,80		6	44	1,00	12,47	80	80,00	1.022,60
K89168500001VTE0	15x15 Color RAL 0004000 Anthracite Glossy	25,10		6	44	1,00	12,47	80	80,00	1.022,60
K89167400001VTE0	15x15 Color RAL 0001500 Black Glossy	25,10		6	44	1,00	12,47	80	80,00	1.022,60

15x15 Matt

K94777600001VTE0	15x15 Color RAL 9016 White Wall Satin Matt	14,00		6	44	1,00	9,50	100	100,00	975,00
K77314500001VTE0	15x15 Color RAL 7047 Light Grey Wall Matt	14,00		6	44	1,00	9,50	100	100,00	975,00
K78209600001VTE0	15x15 Color RAL 0809010 Light Sand Wall Matt	14,00		6	44	1,00	9,50	100	100,00	975,00
K94772800001VTE0	15x15 Color RAL 9016 White Matt	15,70		6	44	1,00	12,47	80	80,00	1.022,60
K85537600001VTE0	15x15 Color RAL 1009005 Ultra White Matt	15,70		6	44	1,00	12,47	80	80,00	1.022,60
K94780700001VTE0	15x15 Color RAL 7047 Light Grey Matt	15,70		6	44	1,00	12,47	80	80,00	1.022,60
K54219100001VTE0	15x15 Color RAL 0958010 Light Mink Matt	15,70		6	44	1,00	12,47	80	80,00	1.022,60
K83941000001VTE0	15x15 Color RAL 0808010 Sand Matt	15,70		6	44	1,00	12,47	80	80,00	1.022,60
K87879300001VTE0	15x15 Color RAL 0809005 Cream Matt	15,70		6	44	1,00	12,47	80	80,00	1.022,60
K89158200001VTE0	15x15 Color RAL 0008000 Grey Matt	17,70		6	44	1,00	12,47	80	80,00	1.022,60
K50284300001VTE0	15x15 Color RAL 0007500 Greige Matt	17,70		6	44	1,00	12,47	80	80,00	1.022,60
K54220200001VTE0	15x15 Color RAL 0806005 Dark Greige Matt	17,70		6	44	1,00	12,47	80	80,00	1.022,60
K54221300001VTE0	15x15 Color RAL 0505010 Mink Matt	17,70		6	44	1,00	12,47	80	80,00	1.022,60
K54240100001VTE0	15x15 Color RAL 1105050 Green Matt	17,70		6	44	1,00	12,47	80	80,00	1.022,60
K54239000001VTE0	15x15 Color RAL 1008080 Lime Green Matt	17,70		6	44	1,00	12,47	80	80,00	1.022,60
K76434100001VTE0	15x15 Color RAL 2606030 Cool Blue Matt	17,70		6	44	1,00	12,47	80	80,00	1.022,60
K89166300001VTE0	15x15 Color RAL 2008020 Calipso Matt	17,70		6	44	1,00	12,47	80	80,00	1.022,60
K50285400001VTE0	15x15 Color RAL 0005500 Dark Grey Matt	19,00		6	44	1,00	12,47	80	80,00	1.022,60
K89163000001VTE0	15x15 Color RAL 0808060 Yellow Matt	19,00		6	44	1,00	12,47	80	80,00	1.022,60
K84914000001VTE0	15x15 Color RAL 2003 Orange Matt	19,00		6	44	1,00	12,47	80	80,00	1.022,60
K87875600001VTE0	15x15 Color RAL 2603035 Aqua Blue Matt	19,00		6	44	1,00	12,47	80	80,00	1.022,60
K80205400001VTE0	15x15 Color RAL 0004000 Anthracite Matt	21,80		6	44	1,00	12,47	80	80,00	1.022,60
K94773000001VTE0	15x15 Color RAL 0001500 Black Matt	21,80		6	44	1,00	12,47	80	80,00	1.022,60
K89159300001VTE0	15x15 Color RAL 0304050 Red Matt	26,10		6	44	1,00	12,47	80	80,00	1.022,60

Product Code Ürün kodu	Product Name Ürün adı	Euro		Thickness (mm) Kalınlık (mm)	Box Kutu		Pallet Palet		
		m ²	Pcs Ad.		Pcs Ad.	m ²	kg	Box Kutu	m ²

15x15 R10B

K94776500001VTE0	15x15 Color RAL 9016 White R10B	17,70		6	44	1,00	12,47	80	80,00	1.022,60
K94776700001VTE0	15x15 Color RAL 7047 Light Grey R10B	17,70		6	44	1,00	12,47	80	80,00	1.022,60
K94776600001VTE0	15x15 Color RAL 0007500 Greige R10B	19,00		6	44	1,00	12,47	80	80,00	1.022,60

20x20 Glossy

K94777700001VTE0	20x20 Color RAL 9016 White Wall Glossy	15,80		6	25	1,00	9,70	96	96,00	956,20
K75907100001VTE0	20x20 Color RAL 9016 White Glossy	18,30		6	25	1,00	12,70	84	84,00	1.091,80
K89196500001VTE0	20x20 Color RAL 1009005 Ultra White Glossy	18,30		6	25	1,00	12,70	84	84,00	1.091,80
K79817100001VTE0	20x20 Color RAL 7047 Light Grey Glossy	18,30		6	25	1,00	12,70	84	84,00	1.091,80
K79809000001VTE0	20x20 Color RAL 0958010 Light Mink Glossy	18,30		6	25	1,00	12,70	84	84,00	1.091,80
K81494300001VTE0	20x20 Color RAL 0809010 Light Sand Glossy	18,30		6	25	1,00	12,70	84	84,00	1.091,80
K79808600001VTE0	20x20 Color RAL 0809005 Cream Glossy	18,30		6	25	1,00	12,70	84	84,00	1.091,80
K89197600001VTE0	20x20 Color RAL 2307015 Pool Blue Glossy	18,30		6	25	1,00	12,70	84	84,00	1.091,80
K81776500001VTE0	20x20 Color RAL 0007500 Greige Glossy	20,10		6	25	1,00	12,70	84	84,00	1.091,80
K79818200001VTE0	20x20 Color RAL 0005500 Dark Grey Glossy	22,10		6	25	1,00	12,70	84	84,00	1.091,80
K76073400001VTE0	20x20 Color RAL 1018 Yellow Glossy	22,10		6	25	1,00	12,70	84	84,00	1.091,80
K89198000001VTE0	20x20 Color RAL 2603035 Aqua Blue Glossy	22,10		6	25	1,00	12,70	84	84,00	1.091,80
K89188400001VTE0	20x20 Color RAL 2010 Orange Glossy	25,50		6	25	1,00	12,70	84	84,00	1.091,80
K76223000001VTE0	20x20 Color RAL 5002 Cobalt Blue Glossy	25,50		6	25	1,00	12,70	84	84,00	1.091,80
K89189500001VTE0	20x20 Color RAL 0004000 Anthracite Glossy	25,50		6	25	1,00	12,70	84	84,00	1.091,80
K79845100001VTE0	20x20 Color RAL 0001500 Black Glossy	25,50		6	25	1,00	12,70	84	84,00	1.091,80
K52647400001VTE0	20x20 Color RAL 3000 Red Glossy	30,50		6	25	1,00	12,70	84	84,00	1.091,80

20x20 Matt

K94777800001VTE0	20x20 Color RAL 9016 White Wall Matt	14,50		6	25	1,00	9,70	96	96,00	956,20
K77574000001VTE0	20x20 Color RAL 7047 Light Grey Wall Matt	14,50		6	25	1,00	9,70	96	96,00	956,20
K78042600001VTE0	20x20 Color RAL 9016 White Matt	15,90		6	25	1,00	12,70	84	84,00	1.091,80
K85532100001VTE0	20x20 Color RAL 1009005 Ultra White Matt	15,90		6	25	1,00	12,70	84	84,00	1.091,80
K78043000001VTE0	20x20 Color RAL 7047 Light Grey Matt	15,90		6	25	1,00	12,70	84	84,00	1.091,80
K94367100001VTE0	20x20 Color RAL 0958010 Light Mink Matt	15,90		6	25	1,00	12,70	84	84,00	1.091,80
K80862400001VTE0	20x20 Color RAL 0809010 Light Sand Matt	15,90		6	25	1,00	12,70	84	84,00	1.091,80
K85531000001VTE0	20x20 Color RAL 0808010 Sand Matt	15,90		6	25	1,00	12,70	84	84,00	1.091,80
K76141200001VTE0	20x20 Color RAL 0809005 Cream Matt	15,90		6	25	1,00	12,70	84	84,00	1.091,80
K94772700001VTE0	20x20 Color RAL 2307015 Pool Blue Matt	15,90		6	25	1,00	12,70	84	84,00	1.091,80
K89182500001VTE0	20x20 Color RAL 0008000 Grey Matt	17,50		6	25	1,00	12,70	84	84,00	1.091,80
K78044100001VTE0	20x20 Color RAL 0007500 Greige Matt	17,50		6	25	1,00	12,70	84	84,00	1.091,80
K94368200001VTE0	20x20 Color RAL 0806005 Dark Greige Matt	17,50		6	25	1,00	12,70	84	84,00	1.091,80
K94369300001VTE0	20x20 Color RAL 0505010 Mink Matt	17,50		6	25	1,00	12,70	84	84,00	1.091,80
K94377400001VTE0	20x20 Color RAL 1007010 Light Khaki Matt	17,50		6	25	1,00	12,70	84	84,00	1.091,80
K94371500001VTE0	20x20 Color RAL 0606020 Soft Brown Matt	17,50		6	25	1,00	12,70	84	84,00	1.091,80
K94376300001VTE0	20x20 Color RAL 0206005 Whisper Lilac Matt	17,50		6	25	1,00	12,70	84	84,00	1.091,80
K94364500001VTE0	20x20 Color RAL 1105050 Green Matt	17,50		6	25	1,00	12,70	84	84,00	1.091,80
K94363400001VTE0	20x20 Color RAL 1008080 Lime Green Matt	17,50		6	25	1,00	12,70	84	84,00	1.091,80
K50220200001VTE0	20x20 Color RAL 2606030 Cool Blue Matt	17,50		6	25	1,00	12,70	84	84,00	1.091,80
K94380000001VTE0	20x20 Color RAL 2306020 Blue Matt	17,50		6	25	1,00	12,70	84	84,00	1.091,80

Color

Product Code Ürün kodu	Product Name Ürün adı	Euro		Thickness (mm) Kalınlık (mm)	Box Kutu		Pallet Palet			
		m ²	Pcs Ad.		Pcs Ad.	m ²	kg	Box Kutu	m ²	kg
K9436600001VTE0	20x20 Color RAL 2006020 Turquoise Matt	17,50		6	25	1,00	12,70	84	84,00	1.091,80
K50219100001VTE0	20x20 Color RAL 2008020 Calipso Matt	17,50		6	25	1,00	12,70	84	84,00	1.091,80
K50209500001VTE0	20x20 Color RAL 0005500 Dark Grey Matt	19,30		6	25	1,00	12,70	84	84,00	1.091,80
K89186200001VTE0	20x20 Color RAL 0808060 Yellow Matt	19,30		6	25	1,00	12,70	84	84,00	1.091,80
K94373000001VTE0	20x20 Color RAL 0706040 Ochre Yellow Matt	19,30		6	25	1,00	12,70	84	84,00	1.091,80
K94379600001VTE0	20x20 Color RAL 0757070 Dark Yellow Matt	19,30		6	25	1,00	12,70	84	84,00	1.091,80
K94378500001VTE0	20x20 Color RAL 2003 Orange Matt	19,30		6	25	1,00	12,70	84	84,00	1.091,80
K94375200001VTE0	20x20 Color RAL 0404005 Basalt Brown Matt	19,30		6	25	1,00	12,70	84	84,00	1.091,80
K94370400001VTE0	20x20 Color RAL 0504040 Tobacco Matt	19,30		6	25	1,00	12,70	84	84,00	1.091,80
K75904500001VTE0	20x20 Color RAL 2603035 Aqua Blue Matt	19,30		6	25	1,00	12,70	84	84,00	1.091,80
K94372600001VTE0	20x20 Color RAL 2205005 Prussian Blue Matt	19,30		6	25	1,00	12,70	84	84,00	1.091,80
K94365600001VTE0	20x20 Color RAL 2404020 Ocean Blue Matt	19,30		6	25	1,00	12,70	84	84,00	1.091,80
K94381100001VTE0	20x20 Color RAL 2004030 Dark Turquoise Matt	19,30		6	25	1,00	12,70	84	84,00	1.091,80
K94374100001VTE0	20x20 Color RAL 2904015 Plum Matt	22,10		6	25	1,00	12,70	84	84,00	1.091,80
K78049500001VTE0	20x20 Color RAL 3004 Burgundy Matt	22,10		6	25	1,00	12,70	84	84,00	1.091,80
K78046300001VTE0	20x20 Color RAL 5002 Cobalt Blue Matt	22,10		6	25	1,00	12,70	84	84,00	1.091,80
K78149200001VTE0	20x20 Color RAL 0004000 Anthracite Matt	22,10		6	25	1,00	12,70	84	84,00	1.091,80
K78047400001VTE0	20x20 Color RAL 0001500 Black Matt	22,10		6	25	1,00	12,70	84	84,00	1.091,80
K89183600001VTE0	20x20 Color RAL 0304050 Red Matt	26,60		6	25	1,00	12,70	84	84,00	1.091,80
K780426C0001VTE0	20x20 Color RAL 9016 White Matt Clean	21,00		6	25	1,00	12,70	84	84,00	1.091,80
K780426S0001VTE0	20x20 Color RAL 9016 White Matt Shield	22,00		6	25	1,00	12,70	84	84,00	1.091,80
20x20 R9A										
K81803400001VTE0	20x20 Color RAL 9016 White R9A	15,90		6	25	1,00	12,70	84	84,00	1.091,80
K81805600001VTE0	20x20 Color RAL 0007500 Greige R9A	17,50		6	25	1,00	12,70	84	84,00	1.091,80
20x20 R10A										
K81976200001VTE0	20x20 Color RAL 0007500 Greige R10A	19,30		6	25	1,00	12,70	84	84,00	1.091,80
20x20 R10B										
K94776800001VTE0	20x20 Color RAL 9016 White R10B	17,50		6	25	1,00	12,70	84	84,00	1.091,80
K94777000001VTE0	20x20 Color RAL 7047 Light Grey R10B	17,50		6	25	1,00	12,70	84	84,00	1.091,80
K89203500001VTE0	20x20 Color RAL 0809010 Light Sand R10B	17,50		6	25	1,00	12,70	84	84,00	1.091,80
K77961200001VTE0	20x20 Color RAL 0809005 Cream R10B	17,50		6	25	1,00	12,70	84	84,00	1.091,80
K94776900001VTE0	20x20 Color RAL 0007500 Greige R10B	19,30		6	25	1,00	12,70	84	84,00	1.091,80
20x40 Glossy										
K94407100001VTE0	20x40 Color RAL 9016 White Wall Glossy	18,30		7	13	1,04	12,27	72	74,88	908,58
20x40 Matt										
K94407000001VTE0	20x40 Color RAL 9016 White Wall Matt	16,80		7	13	1,04	12,27	72	74,88	908,58
K944070S0001VTE0	20x40 Color RAL 9016 White Wall Matt Shield	19,80		7	13	1,04	12,27	72	74,88	908,58
30x30 Glossy										
K78830600001VTE0	30x30 Color RAL 9016 White Glossy	18,30		7	11	1,00	14,79	72	72,00	1.089,88
K52648500001VTE0	30x30 Color RAL 3000 Red Glossy	30,50		7	11	1,00	14,79	72	72,00	1.089,88
30x30 Matt										
K94772900001VTE0	30x30 Color RAL 9016 White Matt	15,90		7	11	1,00	14,79	72	72,00	1.089,88
K94773300001VTE0	30x30 Color RAL 7047 Light Grey Matt	15,90		7	11	1,00	14,79	72	72,00	1.089,88
K80768100001VTE0	30x30 Color RAL 0958010 Light Mink Matt	15,90		7	11	1,00	14,79	72	72,00	1.089,88

Product Code Ürün kodu	Product Name Ürün adı	Euro		Thickness (mm) Kalınlık (mm)	Box Kutu			Pallet Palet		
		m ²	Pcs Ad.		Pcs Ad.	m ²	kg	Box Kutu	m ²	kg
K76899500001VTE0	30x30 Color RAL 0809010 Light Sand Matt	15,90		7	11	1,00	14,79	72	72,00	1.089,88
K77296000001VTE0	30x30 Color RAL 0809005 Cream Matt	15,90		7	11	1,00	14,79	72	72,00	1.089,88
K94777400001VTE0	30x30 Color RAL 2307015 Pool Blue Matt	15,90		7	11	1,00	14,79	72	72,00	1.089,88
K89208300001VTE0	30x30 Color RAL 0008000 Grey Matt	17,50		7	11	1,00	14,79	72	72,00	1.089,88
K94773200001VTE0	30x30 Color RAL 0007500 Greige Matt	17,50		7	11	1,00	14,79	72	72,00	1.089,88
K75444500001VTE0	30x30 Color RAL 0005500 Dark Grey Matt	19,30		7	11	1,00	14,79	72	72,00	1.089,88
K86460500001VTE0	30x30 Color RAL 0004000 Anthracite Matt	22,10		7	11	1,00	14,79	72	72,00	1.089,88
K94773100001VTE0	30x30 Color RAL 0001500 Black Matt	22,10		7	11	1,00	14,79	72	72,00	1.089,88
30x30 R10B										
K94777100001VTE0	30x30 Color RAL 9016 White R10B	17,50		7	11	1,00	14,79	72	72,00	1.089,88
K94777300001VTE0	30x30 Color RAL 7047 Light Grey R10B	17,50		7	11	1,00	14,79	72	72,00	1.089,88
K89216400001VTE0	30x30 Color RAL 0809010 Light Sand R10B	17,50		7	11	1,00	14,79	72	72,00	1.089,88
K89217500001VTE0	30x30 Color RAL 2307015 Pool Blue R10B	17,50		7	11	1,00	14,79	72	72,00	1.089,88
K94777200001VTE0	30x30 Color RAL 0007500 Greige R10B	19,30		7	11	1,00	14,79	72	72,00	1.089,88
30x60 Matt										
K89223400001VTE0	30x60 Color RAL 9016 White Matt	27,50		9	6	1,08	20,12	40	43,20	829,82
K78816600001VTE0	30x60 Color RAL 7047 Light Grey Matt	27,50		9	6	1,08	20,12	40	43,20	829,82
K89233000001VTE0	30x60 Color RAL 0809010 Light Sand Matt	27,50		9	6	1,08	20,12	40	43,20	829,82
K89231500001VTE0	30x60 Color RAL 0007500 Greige Matt	30,30		9	6	1,08	20,12	40	43,20	829,82
K89228200001VTE0	30x60 Color RAL 0005500 Dark Grey Matt	33,30		9	6	1,08	20,12	40	43,20	829,82
K89224500001VTE0	30x60 RAL 0001500 Black Matt	33,30		9	6	1,08	20,12	40	43,20	829,82
K89223450001VTE0	30x60 Color RAL 9016 White Matt Shield	31,50		9	6	1,08	20,12	40	43,20	829,82
30x60 R10A										
K94376500001VTE0	30x60 Color RAL 9016 White R10A	30,30		9	6	1,08	20,12	40	43,20	829,82

Color

Product Code Ürün kodu	Product Name Ürün adı	Euro		Thickness (mm) Kalınlık (mm)	Box Kutu		Pallet Palet		
		m ²	Pcs Ad.		Pcs Ad.	m ²	kg	Box Kutu	m ²

Right-Angled Sit-In

2x10 Covebase External Corner Sit-In

K94951200001VTE0	2x10 RAL 9016 White Covebase Internal Corner Sit-In 6mm Matt IK210		8,00	6	20	0,04	1,04			
K94951300001VTE0	2x10 RAL 1500 Covebase Internal Corner Sit-In 6mm Matt IK210		8,00	6	20	0,04	1,04			
K94951400001VTE0	2x10 RAL 0809005 Covebase Internal Corner Sit-In 6mm Matt IK210		8,00	6	20	0,04	1,04			
K94951500001VTE0	2x10 RAL 7500 Covebase Internal Corner Sit-In 6mm Matt IK210		8,00	6	20	0,04	1,04			
K94951600001VTE0	2x10 RAL 7047 Covebase Internal Corner Sit-In 6mm Matt IK210		8,00	6	20	0,04	1,04			
K94951700001VTE0	2x10 RAL 5500 Covebase Internal Corner Sit-In 6mm Matt IK210		8,00	6	20	0,04	1,04			
K94954900001VTE0	2x10 RAL 0958010 Light Mink Covebase Internal Corner Sit-In 6mm Matt IK210		8,00	6	20	0,04	1,04			

3x10 Covebase External Corner Sit-In

K94951800001VTE0	3x10 RAL 9016 White Covebase External Corner Sit-In 6mm Matt DK1310		12,00	6	12	0,04	1,37			
K94951900001VTE0	3x10 RAL 1500 Covebase External Corner Sit-In 6mm Matt DK1310		12,00	6	12	0,04	1,37			
K94952000001VTE0	3x10 RAL 0809005 Covebase External Corner Sit-In 6mm Matt DK1310		12,00	6	12	0,04	1,37			
K94952100001VTE0	3x10 RAL 7500 Covebase External Corner Sit-In 6mm Matt DK1310		12,00	6	12	0,04	1,37			
K94952200001VTE0	3x10 RAL 7047 Covebase External Corner Sit-In 6mm Matt DK1310		12,00	6	12	0,04	1,37			
K94952300001VTE0	3x10 RAL 5500 Covebase External Corner Sit-In 6mm Matt DK1310		12,00	6	12	0,04	1,37			
K94955000001VTE0	3x10 RAL 0958010 Light Mink Covebase External Corner Sit-In 6mm Matt DK1310		12,00	6	12	0,04	1,37			

10x10 Covebase Sit-In

K94952400001VTE0	10x10 RAL 9016 White Covebase Sit-In 6mm Matt KDI1010		4,80	6	15	0,15	2,10			
K94952500001VTE0	10x10 RAL 1500 Covebase Sit-In 6mm Matt KDI1010		4,80	6	15	0,15	2,10			
K94952600001VTE0	10x10 RAL 0809005 Covebase Sit-In 6mm Matt KDI1010		4,80	6	15	0,15	2,10			
K94952700001VTE0	10x10 RAL 7500 Covebase Sit-In 6mm Matt KDI1010		4,80	6	15	0,15	2,10			
K94952800001VTE0	10x10 RAL 7047 Covebase Sit-In 6mm Matt KDI1010		4,80	6	15	0,15	2,10			
K94952900001VTE0	10x10 RAL 5500 Covebase Sit-In 6mm Matt KDI1010		4,80	6	15	0,15	2,10			
K94947400001VTE0	10x10 RAL 0958010 Light Mink Covebase Sit-In 6mm Matt KDI1010		4,80	6	15	0,15	2,10			

10x20 Covebase Sit-In

K94953000001VTE0	10x20 RAL 9016 White Covebase Sit-In 6mm Matt KDI1020		6,00	6	18	0,36	6,30			
K94953100001VTE0	10x20 RAL 1500 Covebase Sit-In 6mm Matt KDI1020		6,00	6	18	0,36	6,30			
K94953200001VTE0	10x20 RAL 0809005 Covebase Sit-In 6mm Matt KDI1020		6,00	6	18	0,36	6,30			
K94953300001VTE0	10x20 RAL 7500 Covebase Sit-In 6mm Matt KDI1020		6,00	6	18	0,36	6,30			
K94953400001VTE0	10x20 RAL 7047 Covebase Sit-In 6mm Matt KDI1020		6,00	6	18	0,36	6,30			
K94953500001VTE0	10x20 RAL 5500 Covebase Sit-In 6mm Matt KDI1020		6,00	6	18	0,36	6,30			
K94947500001VTE0	10x20 RAL 0958010 Light Mink Covebase Sit-In 6mm Matt KDI1020		6,00	6	18	0,36	6,30			

2x20 Internal Beading Sit-In

K94953600001VTE0	2x20 RAL 9016 White Internal Beading Sit-In 6mm Matt IP220		12,00	6	20	0,06	1,00			
K94953700001VTE0	2x20 RAL 1500 Internal Beading Sit-In 6mm Matt IP220		12,00	6	20	0,06	1,00			
K94953800001VTE0	2x20 RAL 0809005 Internal Beading Sit-In 6mm Matt IP220		12,00	6	20	0,06	1,00			
K94953900001VTE0	2x20 RAL 7500 Internal Beading Sit-In 6mm Matt IP220		12,00	6	20	0,06	1,00			
K94954000001VTE0	2x20 RAL 7047 Internal Beading Sit-In 6mm Matt IP220		12,00	6	20	0,06	1,00			
K94954100001VTE0	2x20 RAL 5500 Internal Beading Sit-In 6mm Matt IP220		12,00	6	20	0,06	1,00			
K94955100001VTE0	2x20 RAL 0958010 Light Mink Internal Beading Sit-In 6mm Matt IP220		12,00	6	20	0,06	1,00			

Product Code Ürün kodu	Product Name Ürün adı	Euro		Thickness (mm) Kalınlık (mm)	Box Kutu		Pallet Palet		
		m ²	Pcs Ad.		Pcs Ad.	m ²	kg	Box Kutu	m ²

2x20 External Beading Sit-In

K94954200001VTE0	2x20 RAL 9016 White External Beading Sit-In 6mm Matt DP220		12,00	6	20	0,06	1,00			
K94954300001VTE0	2x20 RAL 1500 External Beading Sit-In 6mm Matt DP220		12,00	6	20	0,06	1,00			
K94954400001VTE0	2x20 RAL 0809005 External Beading Sit-In 6mm Matt DP220		12,00	6	20	0,06	1,00			
K94954500001VTE0	2x20 RAL 7500 External Beading Sit-In 6mm Matt DP220		12,00	6	20	0,06	1,00			
K94954600001VTE0	2x20 RAL 7047 External Beading Sit-In 6mm Matt DP220		12,00	6	20	0,06	1,00			
K94954700001VTE0	2x20 RAL 5500 External Beading Sit-In 6mm Matt DP220		12,00	6	20	0,06	1,00			
K94955200001VTE0	2x20 RAL 0958010 Light Mink External Beading Sit-In 6mm Matt DP220		12,00	6	20	0,06	1,00			

Covebase Bullnose

5x5 Bullnose

K78566070001VTE0	5x5 RAL 9016 White Bullnose 6mm Matt S886		30,00	6	198	0,50	11,48			
K53919270001VTE0	5x5 RAL 1500 Bullnose 6mm Matt S886		30,00	6	198	0,50	11,48			
K53913370001VTE0	5x5 RAL 0809005 Bullnose 6mm Matt S886		30,00	6	198	0,50	11,48			
K94829670001VTE0	5x5 RAL 7500 Bullnose 6mm Matt S886		30,00	6	198	0,50	11,48			
K79104070001VTE0	5x5 RAL 7047 Bullnose 6mm Matt S886		30,00	6	198	0,50	11,48			
K53916670001VTE0	5x5 RAL 5500 Bullnose 6mm Matt S886		30,00	6	198	0,50	11,48			

5x5 Bullnose Corner

K51648600001VTE0	5x5 RAL 9016 White Bullnose Corner 6mm Matt SC886		6,00	6	28	0,07	0,84			
K53932100001VTE0	5x5 RAL 1500 Bullnose Corner 6mm Matt SC886		6,00	6	28	0,07	0,84			
K53927300001VTE0	5x5 RAL 0809005 Bullnose Corner 6mm Matt SC886		6,00	6	28	0,07	0,84			
K94954800001VTE0	5x5 RAL 7500 Bullnose Corner 6mm Matt SC886		6,00	6	28	0,07	0,84			
K53922500001VTE0	5x5 RAL 7047 Bullnose Corner 6mm Matt SC886		6,00	6	28	0,07	0,84			
K53928400001VTE0	5x5 RAL 5500 Bullnose Corner 6mm Matt SC886		6,00	6	28	0,07	0,84			

5x5 Covebase Internal Corner

K78568200001VTE0	5x5 RAL 9016 White Covebase Internal Corner 6mm Matt CKD55		6,00	6	12	0,04	0,42			
K94828900001VTE0	5x5 RAL 1500 Covebase Internal Corner 6mm Matt CKD55		6,00	6	12	0,04	0,42			
K94829000001VTE0	5x5 RAL 0809005 Covebase Internal Corner 6mm Matt CKD55		6,00	6	12	0,04	0,42			
K94829100001VTE0	5x5 RAL 7500 Covebase Internal Corner 6mm Matt CKD55		6,00	6	12	0,04	0,42			
K79106200001VTE0	5x5 RAL 7047 Covebase Internal Corner 6mm Matt CKD55		6,00	6	12	0,04	0,42			
K94829200001VTE0	5x5 RAL 5500 Covebase Internal Corner 6mm Matt CKD55		6,00	6	12	0,04	0,42			

5x5 Covebase

K78570430001VTE0	5x5 RAL 9016 White Covebase 6mm Matt KDY55		25,50	6	132	0,33	11,88			
K94828530001VTE0	5x5 RAL 1500 Covebase 6mm Matt KDY55		38,80	6	132	0,33	11,88			
K94828630001VTE0	5x5 RAL 0809005 Covebase 6mm Matt KDY55		25,50	6	132	0,33	11,88			
K94828730001VTE0	5x5 RAL 7500 Covebase 6mm Matt KDY55		28,60	6	132	0,33	11,88			
K94828430001VTE0	5x5 RAL 7047 Covebase 6mm Matt KDY55		25,50	6	132	0,33	11,88			
K94828830001VTE0	5x5 RAL 5500 Covebase 6mm Matt KDY55		34,70	6	132	0,33	11,88			

Color

Product Code Ürün kodu	Product Name Ürün adı	Euro		Thickness (mm) Kalınlık (mm)	Box Kutu		Pallet Palet		
		m ²	Pcs Ad.		Pcs Ad.	m ²	kg	Box Kutu	m ²

Shower Inclined Edge

10x10 Shower Inclined End Edge

K78250500001VTE0	10x10 RAL 9016 White Shower Inclined Edge SIE		5,00	6	24	0,24	3,36			
K94827800001VTE0	10x10 RAL 1500 Shower Inclined Edge SIE		7,60	6	24	0,24	3,36			
K94827900001VTE0	10x10 RAL 0809005 Shower Inclined Edge SIE		5,00	6	24	0,24	3,36			
K85713000001VTE0	10x10 RAL 7500 Shower Inclined Edge SIE		5,60	6	24	0,24	3,36			
K78428100001VTE0	10x10 RAL 7047 Shower Inclined Edge SIE		5,00	6	24	0,24	3,36			
K89370400001VTE0	10x10 RAL 5500 Shower Inclined Edge SIE		6,80	6	24	0,24	3,36			

10x10 Shower Inclined End Edge (Internal)

K78251600001VTE0	10x10 RAL 9016 White Shower Inclined Edge Internal SIEEI		5,00	6	24	0,24	3,36			
K94828000001VTE0	10x10 RAL 1500 Shower Inclined Edge Internal SIEEI		7,60	6	24	0,24	3,36			
K94828100001VTE0	10x10 RAL 0809005 Shower Inclined Edge Internal SIEEI		5,00	6	24	0,24	3,36			
K85714100001VTE0	10x10 RAL 7500 Shower Inclined Edge Internal SIEEI		5,60	6	24	0,30	3,36			
K78429200001VTE0	10x10 RAL 7047 Shower Inclined Edge Internal SIEEI		5,00	6	24	0,24	3,36			
K89373000001VTE0	10x10 RAL 5500 Shower Inclined Edge Internal SIEEI		6,80	6	24	0,24	3,36			

10x10 Shower Inclined End Edge (External)

K78252000001VTE0	10x10 RAL 9016 White Shower Inclined Edge External SIEEE		5,00	6	24	0,24	3,36			
K94828200001VTE0	10x10 RAL 1500 Shower Inclined Edge External SIEEE		7,60	6	24	0,24	3,36			
K94828300001VTE0	10x10 RAL 0809005 Shower Inclined Edge External SIEEE		5,00	6	24	0,24	3,36			
K79041000001VTE0	10x10 RAL 7500 Shower Inclined Edge External SIEEE		5,60	6	24	0,24	3,36			
K78430300001VTE0	10x10 RAL 7047 Shower Inclined Edge External SIEEE		5,00	6	24	0,24	3,36			
K89376300001VTE0	10x10 RAL 5500 Shower Inclined Edge External SIEEE		6,80	6	24	0,24	3,36			

All Round

5x10 Internal Beading

K94955300001VTE0	5x10 RAL 9016 White Internal Beading Glossy IP510		10,00	6	54	0,27	10,80			
K94955400001VTE0	5x10 RAL 1500 Internal Beading Glossy IP510		10,00	6	54	0,27	10,80			
K94955500001VTE0	5x10 RAL 0958010 Light Mink Internal Beading Glossy IP510		10,00	6	54	0,27	10,80			
K94955600001VTE0	5x10 RAL 5500 Internal Beading Glossy IP510		10,00	6	54	0,27	10,80			

5x10 External Beading

K94955700001VTE0	5x10 RAL 9016 White External Beading Glossy DP510		10,00	6	66	0,33	13,20			
K94955800001VTE0	5x10 RAL 1500 External Beading Glossy DP510		10,00	6	66	0,33	13,20			
K94955900001VTE0	5x10 RAL 0958010 Light Mink External Beading Glossy DP510		10,00	6	66	0,33	13,20			
K94956000001VTE0	5x10 RAL 5500 External Beading Glossy DP510		10,00	6	66	0,33	13,20			

10x10 Down-Out External Corner

K94956100001VTE0	10x10 RAL 9016 White Down-Out External Corner Glossy ADK1010		10,00	6	3	0,03	0,60			
K94956200001VTE0	10x10 RAL 1500 Down-Out External Corner Glossy ADK1010		10,00	6	3	0,03	0,60			
K94956300001VTE0	10x10 RAL 0958010 Light Mink Down-Out External Corner Glossy ADK1010		10,00	6	3	0,03	0,60			
K94956400001VTE0	10x10 RAL 5500 Down-Out External Corner Glossy ADK1010		10,00	6	3	0,03	0,60			

10x10 Up-In Internal Corner

K94956500001VTE0	10x10 RAL 9016 White Up-In Internal Corner Glossy UIK1010		10,00	6	3	0,03	0,60			
K94956600001VTE0	10x10 RAL 1500 Up-In Internal Corner Glossy UIK1010		10,00	6	3	0,03	0,60			
K94956700001VTE0	10x10 RAL 0958010 Light Mink Up-In Internal Corner Glossy UIK1010		10,00	6	3	0,03	0,60			

Product Code Ürün kodu	Product Name Ürün adı	Euro		Thickness (mm) Kalınlık (mm)	Box Kutu		Pallet Palet			
		m ²	Pcs Ad.		Pcs Ad.	m ²	kg	Box Kutu	m ²	kg
K94956800001VTE0	10x10 RAL 5500 Up-In Internal Corner Glossy UIK1010		10,00	6	3	0,03	0,60			
5x5 Up-Out External Corner										
K94956900001VTE0	5x5 RAL 9016 White Up-Out External Corner Glossy UDK55		12,00	6	2	0,01	0,40			
K94957000001VTE0	5x5 RAL 1500 Up-Out External Corner Glossy UDK55		12,00	6	2	0,01	0,40			
K94957100001VTE0	5x5 RAL 0958010 Light Mink Up-Out External Corner Glossy UDK55		12,00	6	2	0,01	0,40			
K94957200001VTE0	5x5 RAL 5500 Up-Out External Corner Glossy UDK55		12,00	6	2	0,01	0,40			
5x5 Down-In Internal Corner										
K94957300001VTE0	5x5 RAL 9016 White Down-In Internal Corner Glossy AIK55		12,00	6	2	0,01	0,40			
K94957400001VTE0	5x5 RAL 1500 Down-In Internal Corner Glossy AIK55		12,00	6	2	0,01	0,40			
K94957500001VTE0	5x5 RAL 0958010 Light Mink Down-In Internal Corner Glossy AIK55		12,00	6	2	0,01	0,40			
K94957600001VTE0	5x5 RAL 5500 Down-In Internal Corner Glossy AIK55		12,00	6	2	0,01	0,40			

Function

Product Code Ürün kodu	Product Name Ürün adı	Euro		Thickness (mm) Kalınlık (mm)	Box Kutu		Pallet Palet			
		m ²	Pcs Ad.		Pcs Ad.	m ²	kg	Box Kutu	m ²	kg
5X5 Uni										
K50568080001VTE0	5x5 Uni Ivory R10B (NN)	32,50		6	11	1,00	11,70	78	78,00	937,60
K50604180001VTE0	5x5 Uni Grey R10B (NN)	32,50		6	11	1,00	11,70	78	78,00	937,60
K50605280001VTE0	5x5 Uni Black R10B (NN)	37,40		6	11	1,00	11,70	78	78,00	937,60
K50886480001VTE0	5x5 Uni Super White R10B (NN)	45,30		6	11	1,00	11,70	78	78,00	937,60
K51124680001VTE0	5x5 Uni Silver R10B (NN)	35,80		6	11	1,00	11,70	78	78,00	937,60
K52732580001VTE0	5x5 Uni Cement Grey R10B (NN)	32,50		6	11	1,00	11,75	78	78,00	941,50
K94854780001VTE0	5x5 Uni Dark Mink R10B (NN)	38,00		6	11	1,00	11,70	78	78,00	937,60
K94854700001VTE0	5x5 Uni Dark Mink R10B (Loose)	35,50		6	11	1,00	11,70	78	78,00	937,60
5X5 Dotti										
K50567680001VTE0	5x5 Dotti Light Grey R10B (NN)	32,50		6	11	1,00	11,70	78	78,00	937,60
K50576180001VTE0	5x5 Dotti Ivory R10B (NN)	32,50		6	11	1,00	11,70	78	78,00	937,60
K50599380001VTE0	5x5 Dotti Dark Grey R10B (NN)	32,50		6	11	1,00	11,70	78	78,00	937,60
K50610080001VTE0	5x5 Dotti Light Beige R10B (NN)	32,50		6	11	1,00	11,70	78	78,00	937,60
5X5 Color Dot										
K50603080001VTE0	5x5 Color Dot Anthracite R10B (NN)	37,70		6	11	1,00	11,70	78	78,00	937,60
K51182180001VTE0	5x5 Color Dot Grey R10B (NN)	34,30		6	11	1,00	11,70	78	78,00	937,60
K52746580001VTE0	5x5 Color Dot Dark Mink R10B (NN)	37,70		6	11	1,00	11,70	78	78,00	937,60
K51135380001VTE0	5x5 Color Dot Super White R10B (NN)	37,70		6	11	1,00	11,70	78	78,00	937,60
10x10 Uni										
K51565080001VTE0	10x10 Uni Silver R10B (NN)	25,00		6	11	1,00	12,50	78	78,00	1.000,00
K50738280001VTE0	10x10 Uni Super White R10B (NN)	34,50		6	11	1,00	12,30	78	78,00	984,40
K52738480001VTE0	10x10 Uni Cement Grey R10B (NN)	24,80		6	11	1,00	12,30	78	78,00	984,40
K53490080001VTE0	10x10 Uni Dark Mink R10B (NN)	30,00		6	11	1,00	12,30	78	78,00	984,40
K75744100001VTE0	10x10 Uni Ivory Matt R10B (Loose)	21,10		6	50	0,50	6,15	162	81,00	1.021,30
K75744180001VTE0	10x10 Uni Ivory R10B (NN)	24,80		6	11	1,00	12,30	78	78,00	984,40
K75779180001VTE0	10x10 Uni Grey R10B (NN)	24,80		6	11	1,00	12,30	78	78,00	984,40
K76707100001VTE0	10x10 Uni Black Matt R10B (Loose)	34,20		6	50	0,50	6,15	162	81,00	1.021,30
K76707180001VTE0	10x10 Uni Black R10B (NN)	30,00		6	11	1,00	12,30	78	78,00	984,40
10x10 Dotti										
K52016380001VTE0	10x10 Dotti Ivory R10B (NN)	27,90		6	11	1,00	12,50	78	78,00	1.000,00
K52017480001VTE0	10x10 Dotti Light Grey R10B (NN)	27,90		6	11	1,00	12,50	78	78,00	1.000,00
K52018580001VTE0	10x10 Dotti Dark Grey R10B (NN)	27,90		6	11	1,00	12,50	78	78,00	1.000,00
K94939780001VTE0	10x10 Dotti Light Beige R10B (NN)	27,90		6	11	1,00	12,50	78	78,00	1.000,00
10x10 Color Dot										
K51183280001VTE0	10x10 Color Dot Grey R10B (NN)	26,30		6	11	1,00	12,30	78	78,00	984,40
K52752480001VTE0	10x10 Color Dot Dark Mink R10B (NN)	31,90		6	11	1,00	12,30	78	78,00	984,40
K76447080001VTE0	10x10 Color Dot Anthracite R10B (NN)	31,90		6	11	1,00	12,30	78	78,00	984,40
10x15 Dotti										
K76289300001VTE0	10x15 Dotti Ivory Covebase Sit-In 8mm		3,00	8	18	0,27	5,04			
K76290400001VTE0	10x15 Dotti Light Grey Covebase Sit-In 8mm		3,00	8	18	0,27	5,04			
K79362600001VTE0	10x15 Dotti Dark Grey Covebase Sit-In 8mm		3,00	8	18	0,27	5,04			

Product Code Ürün kodu	Product Name Ürün adı	Euro		Thickness (mm) Kalınlık (mm)	Box Kutu			Pallet Palet		
		m ²	Pcs Ad.		Pcs Ad.	m ²	kg	Box Kutu	m ²	kg

15x15 Uni										
K83518400001VTE0	15x15 Uni Ivory R9	17,80		8	44	1,00	15,60	68	68,00	1.085,80
K90073300001VTE0	15x15 Uni Black R9	20,50		8	44	1,00	15,60	68	68,00	1.085,80
K85060000001VTE0	15x15 Uni Ivory Matt R10B	16,50		8	44	1,00	15,60	68	68,00	1.085,80
K85061100001VTE0	15x15 Uni Grey R10B	18,70		8	44	1,00	15,60	68	68,00	1.085,80
15x15 Uni - Mercato										
K94940700001VTE0	15x15 Uni Mercato Ivory R11B	15,00		8	44	1,00	15,60	68	68,00	1.085,80
15x15 Uni - Corund										
K75814000001VTE0	15x15 Uni Corund Ivory R11B	15,00		8	44	1,00	15,60	68	68,00	1.085,80
15x15 Uni - Diamond										
K75813600001VTE0	15x15 Uni Diamond Ivory R12 V4	15,00		8	44	1,00	15,60	68	68,00	1.085,80
15x15 Dotti										
K83515100001VTE0	15x15 Dotti Ivory Matt R9	16,50		8	44	1,00	15,60	68	68,00	1.085,80
K83516200001VTE0	15x15 Dotti Light Grey Matt R9	16,50		8	44	1,00	15,60	68	68,00	1.085,80
K89604000001VTE0	15x15 Dotti Dark Grey Matt R9	16,50		8	44	1,00	15,60	68	68,00	1.085,80
K82376400001VTE0	15x15 Dotti Ivory R10B	17,00		8	44	1,00	15,60	68	68,00	1.085,80
K82377500001VTE0	15x15 Dotti Light Grey R10B	17,00		8	44	1,00	15,60	68	68,00	1.085,80
K82378600001VTE0	15x15 Dotti Dark Grey R10B	17,00		8	44	1,00	15,60	68	68,00	1.085,80
15x15 Dotti - Mercato										
K78965100001VTE0	15x15 Dotti Mercato Dark Grey R11B	19,00		8	44	1,00	15,60	68	68,00	1.085,80
K94940800001VTE0	15x15 Dotti Mercato Ivory R11B	19,00		8	44	1,00	15,60	68	68,00	1.085,80
K82393000001VTE0	15x15 Dotti Mercato Light Grey R11B	19,00		8	44	1,00	15,60	68	68,00	1.085,80
15x15 Dotti - Diamond										
K75781200001VTE0	15x15 Dotti Diamond Light Grey R12 V4	19,00		8	44	1,00	15,60	68	68,00	1.085,80
K75783400001VTE0	15x15 Dotti Diamond Ivory R12 V4	19,00		8	44	1,00	15,60	68	68,00	1.085,80
K85710400001VTE0	15x15 Dotti Diamond Dark Grey R12 V4	19,00		8	44	1,00	15,60	68	68,00	1.085,80
15x15 Dotti - Corund										
K75784500001VTE0	15x15 Dotti Corund Light Grey R11B	19,00		8	44	1,00	15,60	68	68,00	1.085,80
K75786000001VTE0	15x15 Dotti Corund Ivory R11B	19,00		8	44	1,00	15,60	68	68,00	1.085,80
K79360400001VTE0	15x15 Dotti Corund Dark Grey R11B	19,00		8	44	1,00	15,60	68	68,00	1.085,80
10x20 Dotti										
K76287100001VTE0	10x20 Dotti Dark Grey Covebase Sit-In 8mm		3,00	8	18	0,36	6,30			
K76285600001VTE0	10x20 Dotti Ivory Covebase Sit-In 8mm		3,00	8	18	0,36	6,30			
K78713000001VTE0	10x20 Dotti Light Beige Covebase Sit-In 8mm		3,00	8	18	0,36	6,30			
K76286000001VTE0	10x20 Dotti Light Grey Covebase Sit-In 8mm		3,00	8	18	0,36	6,30			
20x20 Uni										
K75865200001VTE0	20x20 Uni Ivory R10A 12mm	24,30		12	16	0,64	15,90	60	38,40	979,24
K76170300001VTE0	20x20 Uni Ivory R10A 14mm	36,90		14	13	0,52	15,34	72	37,44	1.129,48
K94941300001VTE0	20x20 Uni Silver Matt R9	19,60		8	25	1,00	16,30	60	60,00	1.003,00
K94941400001VTE0	20x20 Uni Dark Mink Matt R9	20,50		8	25	1,00	16,30	60	60,00	1.003,00
K83810200001VTE0	20x20 Uni Ivory Matt R10B	18,70		8	25	1,00	16,30	60	60,00	1.003,00
K83550100001VTE0	20x20 Uni Ivory R9	17,80		8	25	1,00	16,30	60	60,00	1.003,00
K83552300001VTE0	20x20 Uni Grey R9	17,80		8	25	1,00	16,30	60	60,00	1.003,00
K83556000001VTE0	20x20 Uni Super White R9	22,20		8	25	1,00	16,30	60	60,00	1.003,00

Function

Product Code Ürün kodu	Product Name Ürün adı	Euro		Thickness (mm) Kalınlık (mm)	Box Kutu		Pallet Palet			
		m ²	Pcs Ad.		Pcs Ad.	m ²	kg	Box Kutu	m ²	kg
K85483100001VTE0	20x20 Uni Cement Grey R9	17,80		8	25	1,00	16,30	60	60,00	1.003,00
K86003300001VTE0	20x20 Uni Black R9	20,50		8	25	1,00	16,30	60	60,00	1.003,00
K77672000001VTE0	20x20 Uni Super White R10A	24,00		8	25	1,00	16,30	60	60,00	1.003,00
K94993400001VTE0	20x20 Uni Silver R10A	18,70		8	25	1,00	16,30	60	60,00	1.003,00
K90892500001VTE0	20x20 Uni Cement Grey R10A	18,70		8	25	1,00	16,67	60	60,00	1.025,20
K80200600001VTE0	20x20 Uni Grey R10A	18,70		8	25	1,00	16,30	60	60,00	1.003,00
K94993500001VTE0	20x20 Uni Dark Mink R10A	18,70		8	25	1,00	16,30	60	60,00	1.003,00
K77291200001VTE0	20x20 Uni Black R10A	21,50		8	25	1,00	16,30	60	60,00	1.003,00
K75874400001VTE0	20x20 Uni Ivory R10A	18,70		8	25	1,00	16,30	60	60,00	1.003,00
20x20 Uni - Mercato										
K76168100001VTE0	20x20 Uni Mercato Ivory R11B 14mm	37,00		14	13	0,52	15,34	72	37,44	1.129,48
K94941800001VTE0	20x20 Uni Mercato Ivory R11B	15,00		8	25	1,00	16,30	60	60,00	1.003,00
K78531000001VTE0	20x20 Uni Mercato Ivory R11B 12mm	24,00		12	16	0,64	15,90	60	38,40	979,24
K94941800001VTE0	20x20 Uni Mercato Ivory R11B	15,00		8	25	1,00	16,30	60	60,00	1.003,00
K78531000001VTE0	20x20 Uni Mercato Ivory R11B 12mm	24,00		12	16	0,64	15,90	60	38,40	979,24
20x20 Uni - Diamond										
K75809200001VTE0	20x20 Uni Diamond Ivory R12 V4	19,00		8	25	1,00	16,30	60	60,00	1.003,00
K75866300001VTE0	20x20 Uni Diamond Ivory R12 V4 12mm	21,00		12	16	0,64	15,90	60	38,40	979,24
20x20 Uni - Corund										
K75867400001VTE0	20x20 Uni Corund Ivory R11B 12mm	24,00		12	16	0,64	15,90	60	38,40	979,24
K75811400001VTE0	20x20 Uni Corund Ivory R11B	15,00		8	25	1,00	16,30	60	60,00	1.003,00
K75811400001VTE0	20x20 Uni Corund Ivory R11B	15,00		8	25	1,00	16,30	60	60,00	1.003,00
20x20 Dotti										
K75780100001VTE0	20x20 Dotti Ivory R10A 12mm	23,00		12	16	0,64	15,90	60	38,40	979,24
K76116500001VTE0	20x20 Dotti Ivory R10A 14mm	34,00		14	13	0,52	15,34	72	37,44	1.129,48
K76117600001VTE0	20x20 Dotti Light Grey R10A 14mm	34,00		14	13	0,52	15,34	72	37,44	1.129,48
K76169200001VTE0	20x20 Dotti Dark Grey R10A 14mm	34,00		14	13	0,52	15,34	72	37,44	1.129,48
K82379000001VTE0	20x20 Dotti Ivory R10B	18,00		8	25	1,00	16,30	60	60,00	1.003,00
K82380100001VTE0	20x20 Dotti Light Grey R10B	18,00		8	25	1,00	16,30	60	60,00	1.003,00
K82381200001VTE0	20x20 Dotti Dark Grey R10B	18,00		8	25	1,00	16,30	60	60,00	1.003,00
K83531300001VTE0	20x20 Dotti Light Beige Matt R9	17,00		8	25	1,00	16,30	60	60,00	1.003,00
K83532400001VTE0	20x20 Dotti Ivory R9	17,00		8	25	1,00	16,30	60	60,00	1.003,00
K83533500001VTE0	20x20 Dotti Light Grey R9	17,00		8	25	1,00	16,30	60	60,00	1.003,00
K83534600001VTE0	20x20 Dotti Dark Grey R9	17,00		8	25	1,00	16,30	60	60,00	1.003,00
K86415200001VTE0	20x20 Dotti Light Grey R10A 12mm	23,00		12	16	0,64	15,90	60	38,40	979,24
K86416300001VTE0	20x20 Dotti Dark Grey R10A 12mm	23,00		12	16	0,64	15,90	60	38,40	979,24
K75674200001VTE0	20x20 Dotti Ivory R10A	18,00		8	25	1,00	16,30	60	60,00	1.003,00
K75445600001VTE0	20x20 Dotti Light Grey R10A	18,00		8	25	1,00	16,30	60	60,00	1.003,00
K75446000001VTE0	20x20 Dotti Dark Grey R10A	18,00		8	25	1,00	16,30	60	60,00	1.003,00
K78714200001VTE0	20x20 Dotti Light Beige R10A	18,00		8	25	1,00	16,67	60	60,00	1.025,20
20x20 Dotti - Mercato										
K78138400001VTE0	20x20 Dotti Mercato Light Grey R11B	19,00		8	25	1,00	16,30	60	60,00	1.003,00
K78139500001VTE0	20x20 Dotti Mercato Dark Grey R11B	19,00		8	25	1,00	16,30	60	60,00	1.003,00
K78140600001VTE0	20x20 Dotti Mercato Ivory R11B	19,00		8	25	1,00	16,30	60	60,00	1.003,00

Product Code Ürün kodu	Product Name Ürün adı	Euro		Thickness (mm) Kalınlık (mm)	Box Kutu			Pallet Palet		
		m ²	Pcs Ad.		Pcs Ad.	m ²	kg	Box Kutu	m ²	kg
K78141000001VTE0	20x20 Dotti Mercato Light Grey R11B 12mm	24,00		12	16	0,64	15,90	60	38,40	979,24
K78142100001VTE0	20x20 Dotti Mercato Dark Grey R11B 12mm	24,00		12	16	0,64	15,90	60	38,40	979,24
K78143200001VTE0	20x20 Dotti Mercato Ivory R11B 12mm	24,00		12	16	0,64	15,90	60	38,40	979,24
K76165500001VTE0	20x20 Dotti Mercato Ivory R11B 14mm	36,90		14	13	0,52	15,34	72	37,44	1.129,48
K76166600001VTE0	20x20 Dotti Mercato Light Grey R11B 14mm	34,00		14	13	0,52	15,34	72	37,44	1.129,48
K76167000001VTE0	20x20 Dotti Mercato Dark Grey R11B 14mm	34,00		14	13	0,52	15,34	72	37,44	1.129,48
20x20 Dotti - Diamond										
K75792000001VTE0	20x20 Dotti Diamond Light Grey R12 V4	26,00		8	25	1,00	16,30	60	60,00	1.003,00
K75793100001VTE0	20x20 Dotti Diamond Dark Grey R12 V4	26,00		8	25	1,00	16,30	60	60,00	1.003,00
K75794200001VTE0	20x20 Dotti Diamond Ivory R12 V4	26,00		8	25	1,00	16,30	60	60,00	1.003,00
K75868500001VTE0	20x20 Dotti Diamond Light Grey R12 V4 12mm	33,00		12	16	0,64	15,90	60	38,40	979,24
K75872200001VTE0	20x20 Dotti Diamond Ivory R12 V4 12mm	33,00		12	16	0,64	15,90	60	38,40	979,24
K75870000001VTE0	20x20 Dotti Diamond Dark Grey R12 V4 12mm	33,00		12	16	0,64	15,90	60	38,40	979,24
20x20 Dotti - Corund										
K75789400001VTE0	20x20 Dotti Corund Light Grey R11B	19,00		8	25	1,00	16,30	60	60,00	1.003,00
K75790500001VTE0	20x20 Dotti Corund Dark Grey R11B	19,00		8	25	1,00	16,30	60	60,00	1.003,00
K75791600001VTE0	20x20 Dotti Corund Ivory R11B	19,00		8	25	1,00	16,30	60	60,00	1.003,00
K75869600001VTE0	20x20 Dotti Corund Light Grey R11B 12mm	24,00		12	16	0,64	15,90	60	38,40	979,24
K75871100001VTE0	20x20 Dotti Corund Dark Grey R11B 12mm	24,00		12	16	0,64	15,90	60	38,40	979,24
K75873300001VTE0	20x20 Dotti Corund Ivory R11B 12mm	24,00		12	16	0,64	15,90	60	38,40	979,24
20x20 Color Dot										
K83542000001VTE0	20x20 Color Dot Anthracite R9	22,00		8	25	1,00	16,30	60	60,00	1.003,00
K85493400001VTE0	20x20 Color Dot Dark Mink R9	22,00		8	25	1,00	16,30	60	60,00	1.003,00
K83541600001VTE0	20x20 Color Dot Grey R9	26,40		8	25	1,00	16,30	60	60,00	1.003,00
K80262500001VTE0	20x20 Color Dot Grey R10A	21,00		8	25	1,00	16,30	60	60,00	1.003,00
K94993600001VTE0	20x20 Color Dot Dark Mink R10A	21,00		8	25	1,00	16,30	60	60,00	1.003,00
K76706000001VTE0	20x20 Color Dot Anthracite R10A	23,00		8	25	1,00	16,30	60	60,00	1.003,00
20x20 Color Dot - Diamond										
K87748500001VTE0	20x20 Color Dot Diamond Anthracite R12 V4	33,00		8	25	1,00	16,30	60	60,00	1.003,00
30x30 Uni										
K83580300001VTE0	30x30 Uni Ivory R9	17,80		8	11	1,00	16,14	60	60,00	993,40
K83581400001VTE0	30x30 Uni Grey R9	17,80		8	11	1,00	16,14	60	60,00	993,40
K83583600001VTE0	30x30 Uni Silver R9	19,60		8	11	1,00	16,14	60	60,00	993,40
K83584000001VTE0	30x30 Uni Black R9	20,50		8	11	1,00	16,14	60	60,00	993,40
K83591000001VTE0	30x30 Uni Super White R9	22,20		8	11	1,00	16,14	60	60,00	993,40
K85485300001VTE0	30x30 Uni Cement Grey R9	17,80		8	11	1,00	16,14	60	60,00	993,40
K89245500001VTE0	30x30 Uni Dark Mink R9	20,50		8	11	1,00	16,14	60	60,00	993,40
K83135600001VTE0	30x30 Uni Ivory Matt R10B	16,50		8	11	1,00	16,63	60	60,00	1.022,80
K82516400001VTE0	30x30 Uni Ivory 12mm R10A	24,40		12	11	1,00	25,33	38	38,00	987,54
K77645100001VTE0	30x30 Uni Super White R10A	21,00		8	11	1,00	16,09	60	60,00	990,40
K80516300001VTE0	30x30 Uni Silver R10A	20,60		8	11	1,00	16,14	60	60,00	993,40
K94993700001VTE0	30x30 Uni Cement Grey R10A	20,60		8	11	1,00	16,14	60	60,00	993,40
K75168200001VTE0	30x30 Uni Grey R10A	18,70		8	11	1,00	16,14	60	60,00	993,40
K94993800001VTE0	30x30 Uni Dark Mink R10A	18,70		8	11	1,00	16,14	60	60,00	993,40

Function

Product Code Ürün kodu	Product Name Ürün adı	Euro		Thickness (mm) Kalınlık (mm)	Box Kutu		Pallet Palet			
		m ²	Pcs Ad.		Pcs Ad.	m ²	kg	Box Kutu	m ²	kg
K75170400001VTE0	30x30 Uni Black R10A	21,50		8	11	1,00	16,14	60	60,00	993,40
K75164500001VTE0	30x30 Uni Ivory R10A	18,70		8	11	1,00	16,14	60	60,00	993,40
30x30 Uni - Mercato										
K79122400001VTE0	30x30 Uni Mercato Ivory R11B	20,60		8	11	1,00	16,14	60	60,00	993,40
K94943000001VTE0	30x30 Uni Mercato Ivory R11B 12mm	23,80		12	11	1,00	25,33	38	38,00	987,54
30x30 Uni - Corund										
K79118000001VTE0	30x30 Uni Corund Ivory R11B	20,50		8	11	1,00	16,63	60	60,00	1.022,80
30x30 Dotti										
K83559300001VTE0	30x30 Dotti Light Grey R9	17,00		8	11	1,00	16,15	60	60,00	994,00
K82383400001VTE0	30x30 Dotti Light Grey R10B	17,00		8	11	1,00	16,15	60	60,00	994,00
K82384500001VTE0	30x30 Dotti Dark Grey R10B	17,00		8	11	1,00	16,15	60	60,00	994,00
K82382300001VTE0	30x30 Dotti Ivory Matt R10B	17,00		8	11	1,00	16,15	60	60,00	994,00
K82515300001VTE0	30x30 Dotti Dark Grey 12mm R10A	23,00		12	11	1,00	25,33	38	38,00	987,54
K82513100001VTE0	30x30 Dotti Ivory R10A 12mm	23,00		12	11	1,00	25,35	38	38,00	988,30
K82514200001VTE0	30x30 Dotti Light Grey R10A 12mm	23,00		12	11	1,00	25,35	38	38,00	988,30
K83558200001VTE0	30x30 Dotti Ivory R9	17,00		8	11	1,00	16,15	60	60,00	994,00
K83560400001VTE0	30x30 Dotti Dark Grey R9	17,00		8	11	1,00	16,15	60	60,00	994,00
K83562600001VTE0	30x30 Dotti Light Beige R9	17,00		8	11	1,00	16,15	60	60,00	994,00
K75162300001VTE0	30x30 Dotti Ivory R10A	17,00		8	11	1,00	16,15	60	60,00	994,00
K75158600001VTE0	30x30 Dotti Light Grey R10A	17,00		8	11	1,00	16,15	60	60,00	994,00
K75160100001VTE0	30x30 Dotti Dark Grey R10A	17,00		8	11	1,00	16,15	60	60,00	994,00
K76566000001VTE0	30x30 Dotti Light Beige R10A	17,00		8	11	1,00	16,15	60	60,00	994,00
30x30 Dotti - Mercato										
K78144300001VTE0	30x30 Dotti Mercato Light Grey R11B	19,00		8	11	1,00	16,15	60	60,00	994,00
K78145400001VTE0	30x30 Dotti Mercato Dark Grey R11B	19,00		8	11	1,00	16,15	60	60,00	994,00
K78146600001VTE0	30x30 Dotti Mercato Ivory R11B	19,00		8	11	1,00	16,15	60	60,00	994,00
K94943200001VTE0	30x30 Dotti Mercato Ivory R11B 12mm	22,00		12	11	1,00	25,33	38	38,00	987,54
K84468200001VTE0	30x30 Dotti Mercato Dark Grey R11B 12mm	22,00		12	11	1,00	25,33	38	38,00	987,54
K89711200001VTE0	30x30 Dotti Mercato Light Grey R11B 12mm	22,00		12	11	1,00	25,35	38	38,00	988,30
30x30 Dotti - Corund										
K79110600001VTE0	30x30 Dotti Corund Light Grey R11B	19,00		8	11	1,00	16,15	60	60,00	994,00
K79111000001VTE0	30x30 Dotti Corund Dark Grey R11B	19,00		8	11	1,00	16,15	60	60,00	994,00
K79112100001VTE0	30x30 Dotti Corund Ivory R11B	19,00		8	11	1,00	16,15	60	60,00	994,00
30x30 Color Dot										
K83570000001VTE0	30x30 Color Dot Grey R9	19,80		8	11	1,00	16,15	60	60,00	994,00
K83571100001VTE0	30x30 Color Dot Anthracite R9	20,80		8	11	1,00	16,15	60	60,00	994,00
K85499300001VTE0	30x30 Color Dot Dark Mink R9	20,80		8	11	1,00	16,15	60	60,00	994,00
K83572200001VTE0	30x30 Color Dot Super White R9	24,70		8	11	1,00	16,15	60	60,00	994,00
K80263600001VTE0	30x30 Color Dot Grey R10A	20,80		8	11	1,00	16,15	60	60,00	994,00
K86128200001VTE0	30x30 Color Dot Dark Mink R10A	21,80		8	11	1,00	16,15	60	60,00	994,00
K75799600001VTE0	30x30 Color Dot Anthracite R10A	21,80		8	11	1,00	16,15	60	60,00	994,00
K75862600001VTE0	30x30 Color Dot Anthracite Tread		4,00	8	11	1,00	16,17			
30x60 Uni										
K76698600001VTE0	30x60 Uni Ivory R9	26,30		9	6	1,08	20,30	40	43,20	837,16

Product Code Ürün kodu	Product Name Ürün adı	Euro		Thickness (mm) Kalınlık (mm)	Box Kutu			Pallet Palet		
		m ²	Pcs Ad.		Pcs Ad.	m ²	kg	Box Kutu	m ²	kg

30x60 Dotti

K76612400001VTE0	30x60 Dotti Light Grey R9	25,50		9	6	1,08	20,30	40	43,20	837,16
K76614600001VTE0	30x60 Dotti Ivory R9	25,50		9	6	1,08	20,30	40	43,20	837,16
K76825200001VTE0	30x60 Dotti Dark Grey R9	25,50		9	6	1,08	20,30	40	43,20	837,16
K94705400001VTE0	30x60 Dotti Açık Gri R10B	28,50		9	6	1,08	20,30	40	43,20	837,16
K94705300001VTE0	30x60 Dotti Koyu Gri R10B	28,50		9	6	1,08	20,30	40	43,20	837,16

30x60 Color Dot

K95007900001VTE0	30x60 Color Dot Antrasit R10B	28,50		9	6	1,08	20,30	40	43,20	837,16
------------------	-------------------------------	-------	--	---	---	------	-------	----	-------	--------

60x60 Uni

K768704R0001VTE0*	60x60 Uni Ivory R9 7Rec	32,50		9	4	1,44	26,90	30	43,20	831,98
K949437R0001VTE0*	60x60 Uni Ivory 14mm R10A 7Rec	57,60		14	2	0,72	21,46	40	28,80	883,24

60x60 Dotti

K768542R0001VTE0*	60x60 Dotti Ivory R9 7Rec	32,00		9	4	1,44	26,90	30	43,20	831,98
K768505R0001VTE0*	60x60 Dotti Light Grey Matt R9 7Rec	32,00		9	4	1,44	26,29	30	43,20	813,83
K949436R0001VTE0*	60x60 Dotti Dark Grey Matt R9 7Rec	32,00		9	4	1,44	27,94	30	43,20	863,08
K949438R0001VTE0*	60x60 Dotti Ivory 14mm R10A 7Rec	57,60		14	2	0,72	21,46	40	28,80	883,24
K949439R0001VTE0*	60x60 Dotti Light Grey 14mm R10A 7Rec	58,50		14	2	0,72	21,46	40	28,80	883,24
K949440R0001VTE0*	60x60 Dotti Dark Grey 14mm R10A 7Rec	58,50		14	2	0,72	21,46	40	28,80	883,24

*1987 m² MOQ is applied to 60x60 Uni and Dotti 9 mm and 14 mm products.

*60x60 Uni ve Dotti 9 mm ve 14 mm ürünlerine 1987 m² MOQ uygulanmaktadır.

Function

Product Code Ürün kodu	Product Name Ürün adı	Euro		Thickness (mm) Kalınlık (mm)	Box Kutu		Pallet Palet		
		m ²	Pcs Ad.		Pcs Ad.	m ²	kg	Box Kutu	m ²

Right Angled Sit-In

3x10 Covebase External Corner Sit-In

K76931100001VTE0	3x10 Dotti Light Beige Covebase External Corner Sit-in 8mm		3,00	8	12	0,04	1,40			
K76297400001VTE0	3x10 Dotti Dark Grey Covebase External Corner Sit-in 8mm		3,50	8	12	0,04	1,40			
K76296300001VTE0	3x10 Dotti Light Grey Covebase External Corner Sit-in 8mm		3,50	8	12	0,04	1,40			
K76295200001VTE0	3x10 Dotti Ivory Covebase External Corner Sit-in 8mm		3,50	8	12	0,04	1,40			
K76299600001VTE0	3x10 Uni Ivory Covebase External Corner Sit-in 8mm		3,50	8	12	0,04	1,40			
K76939200001VTE0	3x10 Color Dot Anthracite Covebase External Corner Sit-in 8mm		3,50	8	12	0,04	1,40			
K82045100001VTE0	3x10 Uni Ivory Covebase External Corner Sit-In 6mm DK1310		6,00	6	12	0,04	1,37			
K82047300001VTE0	3x10 Dotti Ivory Covebase External Corner Sit-In 6mm DK1310		6,00	6	12	0,04	1,37			
K82053200001VTE0	3x10 Dotti Light Grey Covebase External Corner Sit-In 6mm DK1310		6,00	6	12	0,04	1,37			
K82054300001VTE0	3x10 Dotti Dark Grey Covebase External Corner Sit-In 6mm DK1310		6,00	6	12	0,04	1,37			
K83511400001VTE0	3x10 Uni Grey Covebase External Corner Sit-In 6mm DK1310		6,00	6	12	0,04	1,37			
K87657500001VTE0	3x10 Uni Black Covebase External Corner Sit-In 6mm DK1310		6,00	6	12	0,04	1,37			

2x10 Covebase Internal Corner Sit-In

K82022600001VTE0	2x10 Uni Ivory Covebase Internal Corner Sit-In 6mm IK210		4,00	6	20	0,04	1,04			
K82024100001VTE0	2x10 Dotti Ivory Covebase Internal Corner Sit-In 6mm IK210		4,00	6	20	0,04	1,04			
K82030000001VTE0	2x10 Dotti Light Grey Covebase Internal Corner Sit-In 6mm IK210		4,00	6	20	0,04	1,04			
K82031100001VTE0	2x10 Dotti Dark Grey Covebase Internal Corner Sit-In 6mm IK210		4,00	6	20	0,04	1,04			
K83512500001VTE0	2x10 Uni Grey Covebase Internal Corner Sit-In 6mm IK210		4,00	6	20	0,04	1,04			
K87656400001VTE0	2x10 Uni Black Covebase Internal Corner Sit-In 6mm IK210		4,00	6	20	0,04	1,04			
K76298500001VTE0	2x10 Uni Ivory Covebase Internal Corner Sit-In 8mm		4,30	8	20	0,04	1,04			
K76292600001VTE0	2x10 Dotti Ivory Covebase Internal Corner Sit-In 8mm		4,30	8	20	0,04	1,04			
K76936600001VTE0	2x10 Dotti Light Beige Covebase Internal Corner Sit-In 8mm		4,30	8	20	0,04	1,04			
K76293000001VTE0	2x10 Dotti Light Grey Covebase Internal Corner Sit-In 8mm		4,30	8	20	0,04	1,04			
K76294100001VTE0	2x10 Dotti Dark Grey Covebase Internal Corner Sit-In 8mm		4,30	8	20	0,04	1,04			
K76941400001VTE0	2x10 Color Dot Anthracite Covebase Internal Corner Sit-In 8mm		4,30	8	20	0,04	1,04			

10x10 Covebase Sit-In

K79141200001VTE0	10x10 Uni Ivory Covebase Sit-In 6mm KDI1010		2,40	6	15	0,15	2,10			
K79131600001VTE0	10x10 Dotti Ivory Covebase Sit-In 6mm KDI1010		2,40	6	15	0,15	2,10			
K78997500001VTE0	10x10 Dotti Light Grey Covebase Sit-In 6mm KDI1010		2,40	6	15	0,15	2,10			
K79138600001VTE0	10x10 Dotti Dark Grey Covebase Sit-In 6mm KDI1010		2,40	6	15	0,15	2,10			
K94948500001VTE0	10x10 Uni Grey Covebase Sit-In 6mm KDI1010		2,40	6	15	0,15	2,10			
K94948600001VTE0	10x10 Uni Black Covebase Sit-In 6mm KDI1010		2,40	6	15	0,15	2,10			

10x15 Covebase Sit-In

K76289300001VTE0	10x15 Dotti Ivory Covebase Sit-In 8mm		3,00	8	18	0,27	5,00			
K76290400001VTE0	10x15 Dotti Light Grey Covebase Sit-In 8mm		3,00	8	18	0,27	5,00			
K79362600001VTE0	10x15 Dotti Dark Grey Covebase Sit-In 8mm		3,00	8	18	0,27	5,00			

10x20 Covebase Sit-In

K76287100001VTE0	10x20 Dotti Dark Grey Covebase Sit-In 8mm		3,00	8	18	0,36	6,70			
K76285600001VTE0	10x20 Dotti Ivory Covebase Sit-In 8mm		3,00	8	18	0,36	6,70			
K78713000001VTE0	10x20 Dotti Light Beige Covebase Sit-In 8mm		3,00	8	18	0,36	6,70			

Product Code Ürün kodu	Product Name Ürün adı	Euro		Thickness (mm) Kalınlık (mm)	Box Kutu		Pallet Palet			
		m ²	Pcs Ad.		Pcs Ad.	m ²	kg	Box Kutu	m ²	kg
K7628600001VTE0	10x20 Dotti Light Grey Covebase Sit-In 8mm		3,00	8	18	0,36	6,70			
K76288200001VTE0	10x20 Uni Ivory Covebase Sit-In 8mm		3,00	8	18	0,36	6,70			
K78477200001VTE0	10x20 Color Dot Anthracite Covebase Sit-In 8mm		3,00	8	18	0,36	6,70			
K94948700001VTE0	10x20 Uni Ivory Covebase Sit-In 6mm KDI1020		3,00	6	18	0,36	6,30			
K94948800001VTE0	10x20 Dotti Ivory Covebase Sit-In 6mm KDI1020		3,00	6	18	0,36	6,30			
K94948900001VTE0	10x20 Dotti Light Grey Covebase Sit-In 6mm KDI1020		3,00	6	18	0,36	6,30			
K94949000001VTE0	10x20 Dotti Dark Grey Covebase Sit-In 6mm KDI1020		3,00	6	18	0,36	6,30			
K94949100001VTE0	10x20 Uni Grey Covebase Sit-In 6mm KDI1020		3,00	6	18	0,36	6,30			
K94949200001VTE0	10x20 Uni Black Covebase Sit-In 6mm KDI1020		3,00	6	18	0,36	6,30			
2x20 Internal - External Beading Sit-In										
K94949300001VTE0	2x20 Uni Ivory Internal External Beading Sit-In 6mm IDP220		6,00	6	20	0,06	1,00			
K94949400001VTE0	2x20 Dotti Ivory Internal External Beading Sit-In 6mm IDP220		6,00	6	20	0,06	1,00			
K94949500001VTE0	2x20 Dotti Light Grey Internal External Beading Sit-In 6mm IDP220		6,00	6	20	0,06	1,00			
K94949600001VTE0	2x20 Dotti Dark Grey Internal External Beading Sit-In 6mm IDP220		6,00	6	20	0,06	1,00			
K94949700001VTE0	2x20 Uni Grey Internal External Beading Sit-In 6mm IDP220		6,00	6	20	0,06	1,00			
K94949800001VTE0	2x20 Uni Black Internal External Beading Sit-In 6mm IDP220		6,00	6	20	0,06	1,00			
Round Angled Sit-On										
3x10 Covebase Internal Corner Sit-On										
K77041600001VTE0	3x10 Uni Ivory Covebase Internal Corner Sit-On 8mm IK310		4,20	8	20	0,06	1,20			
K77040500001VTE0	3x10 Dotti Ivory Covebase Internal Corner Sit-On 8mm IK310		4,20	8	20	0,06	1,20			
K77042000001VTE0	3x10 Dotti Light Grey Covebase Internal Corner Sit-On 8mm IK310		4,20	8	20	0,06	1,20			
K77043100001VTE0	3x10 Dotti Dark Grey Covebase Internal Corner Sit-On 8mm IK310		4,20	8	20	0,06	1,20			
K94947100001VTE0	3x10 Uni Grey Covebase Internal Corner Sit-On 8mm IK310		4,20	8	20	0,06	1,20			
K94947200001VTE0	3x10 Uni Black Covebase Internal Corner Sit-On 8mm IK310		4,20	8	20	0,06	1,20			
3x10 Covebase External Corner Sit-On										
K77045300001VTE0	3x10 Uni Ivory Covebase External Corner Sit-On 8mm DKO310		4,20	8	12	0,04	1,68			
K77044200001VTE0	3x10 Dotti Ivory Covebase External Corner Sit-On 8mm DKO310		4,20	8	12	0,04	1,68			
K77046400001VTE0	3x10 Dotti Light Grey Covebase External Corner Sit-On 8mm DKO310		4,20	8	12	0,04	1,68			
K77047500001VTE0	3x10 Dotti Dark Grey Covebase External Corner Sit-On 8mm DKO310		4,20	8	12	0,04	1,68			
K94947300001VTE0	3x10 Uni Grey Covebase External Corner Sit-On 8mm DKO310		4,20	8	12	0,04	1,68			
K84712100001VTE0	3x10 Uni Black Covebase External Corner Sit-On 8mm DKO310		4,20	8	12	0,04	1,68			
10x20 Covebase Sit-On										
K77037200001VTE0	10x20 Uni Ivory Covebase Sit-On 8mm KDO1020		3,00	8	18	0,36	6,30			
K77036100001VTE0	10x20 Dotti Ivory Covebase Sit-On 8mm KDO1020		3,00	8	18	0,36	6,30			
K77038300001VTE0	10x20 Dotti Light Grey Covebase Sit-On 8mm KDO1020		3,00	8	18	0,36	6,30			
K77039400001VTE0	10x20 Dotti Dark Grey Covebase Sit-On 8mm KDO1020		3,00	8	18	0,36	6,30			
K86083600001VTE0	10x20 Uni Grey Covebase Sit-On 8mm KDO1020		3,00	8	18	0,36	6,30			
K91237000001VTE0	10x20 Uni Black Covebase Sit-On 8mm KDO1020		3,00	8	18	0,36	5,90			
3x20 Internal-External Beading Sit-On										
K86801300001VTE0	3x20 Uni Ivory Internal External Beading Sit-On 8mm IDP320		6,00	8	20	0,06	1,50			
K94949900001VTE0	3x20 Dotti Ivory Internal External Beading Sit-On 8mm IDP320		6,00	8	20	0,06	1,50			
K94950000001VTE0	3x20 Dotti Light Grey Internal External Beading Sit-On 8mm IDP320		6,00	8	20	0,06	1,50			

Function

Product Code Ürün kodu	Product Name Ürün adı	Euro		Thickness (mm) Kalınlık (mm)	Box Kutu		Pallet Palet			
		m ²	Pcs Ad.		Pcs Ad.	m ²	kg	Box Kutu	m ²	kg
K94950100001VTE0	3x20 Dotti Dark Grey Internal External Beading Sit-On 8mm IDP320		6,00	8	20	0,06	1,50			
K86909600001VTE0	3x20 Uni Grey Internal External Beading Sit-On 8mm IDP320		6,00	8	20	0,06	1,50			
K94950200001VTE0	3x20 Uni Black Internal External Beading Sit-On 8mm IDP320		6,00	8	20	0,06	1,50			
Covebase Bullnose										
5X5 Bullnose										
K80343270001VTE0	5x5 Uni Ivory Bullnose 6mm S886		15,00	6	198	0,50	11,48			
K51299070001VTE0	5x5 Dotti Ivory Bullnose 6mm S886		15,00	6	198	0,50	11,48			
K80408470001VTE0	5x5 Dotti Light Grey Bullnose 6mm S886		15,00	6	198	0,50	11,48			
K51300170001VTE0	5x5 Dotti Dark Grey Bullnose 6mm S886		15,00	6	198	0,50	11,48			
K80362070001VTE0	5x5 Uni Grey Bullnose 6mm S886		15,00	6	198	0,50	11,48			
K80352470001VTE0	5x5 Uni Black Bullnose 6mm S886		15,00	6	198	0,50	11,48			
5X5 Bullnose Corner										
K80345400001VTE0	5x5 Uni Ivory Bullnose Corner 6mm SC886		2,30	6	28	0,07	0,84			
K51314100001VTE0	5x5 Dotti Ivory Bullnose Corner 6mm SC886		2,30	6	28	0,07	0,84			
K51316300001VTE0	5x5 Dotti Light Grey Bullnose Corner 6mm SC886		2,30	6	28	0,07	0,84			
K51315200001VTE0	5x5 Dotti Dark Grey Bullnose Corner 6mm SC886		2,30	6	28	0,07	0,84			
K80364200001VTE0	5x5 Uni Grey Bullnose Corner 6mm SC886		2,30	6	28	0,07	0,84			
K80354600001VTE0	5x5 Uni Black Bullnose Corner 6mm SC886		2,30	6	28	0,07	0,84			
5x5 Covebase Internal Corner										
K86199300001VTE0	5x5 Uni Ivory Covebase Internal Corner 6mm CKD55		3,00	6	12	0,03	0,18			
K86200400001VTE0	5x5 Dotti Ivory Covebase Internal Corner 6mm CKD55		3,00	6	12	0,03	0,18			
K94950300001VTE0	5x5 Dotti Light Grey Covebase Internal Corner 6mm CKD55		3,00	6	12	0,03	0,18			
K94950400001VTE0	5x5 Dotti Dark Grey Covebase Internal Corner 6mm CKD55		3,00	6	12	0,03	0,18			
K94950500001VTE0	5x5 Uni Grey Covebase Internal Corner 6mm CKD55		3,00	6	12	0,03	0,18			
K94950600001VTE0	5x5 Uni Black Covebase Internal Corner 6mm CKD55		3,00	6	12	0,03	0,18			
5X5 Covebase										
K86191230001VTE0	5x5 Uni Ivory Covebase 6mm KDY55		20,00	6	132	0,33	11,88			
K86192330001VTE0	5x5 Dotti Ivory Covebase 6mm KDY55		20,00	6	132	0,33	11,88			
K94950730001VTE0	5x5 Dotti Light Grey Covebase 6mm KDY55		20,00	6	132	0,33	11,88			
K94950830001VTE0	5x5 Dotti Dark Grey Covebase 6mm KDY55		20,00	6	132	0,33	11,88			
K86624130001VTE0	5x5 Uni Grey Covebase 6mm KDY55		20,00	6	132	0,33	11,88			
K94950930001VTE0	5x5 Uni Black Covebase 6mm KDY55		20,00	6	132	0,33	11,88			
Shower Inclined Edge										
10x10 Shower Inclined End Edge										
K78607600001VTE0	10x10 Uni Ivory Shower Inclined Edge SIE		5,00	6	24	0,24	3,36			
K86096500001VTE0	10x10 Dotti Ivory Shower Inclined Edge SIE		5,00	6	24	0,24	3,36			
K86099100001VTE0	10x10 Dotti Light Grey Shower Inclined Edge SIE		5,00	6	24	0,24	3,36			
K86102400001VTE0	10x10 Dotti Dark Grey Shower Inclined Edge SIE		5,00	6	24	0,24	3,36			
K80457300001VTE0	10x10 Uni Grey Shower Inclined Edge SIE		5,00	6	24	0,24	3,36			
K88672600001VTE0	10x10 Uni Black Shower Inclined Edge SIE		5,00	6	24	0,24	3,36			
K86114200001VTE0	10x10 Color Dot Anthracite Shower Inclined Edge SIE		5,00	6	24	0,24	3,36			

Product Code Ürün kodu	Product Name Ürün adı	Euro		Thickness (mm) Kalınlık (mm)	Box Kutu		Pallet Palet		
		m ²	Pcs Ad.		Pcs Ad.	m ²	kg	Box Kutu	m ²

10x10 Shower Inclined End Edge (Internal)

K7860800001VTE0	10x10 Uni Ivory Shower Inclined Edge Internal SIEEI		5,00	6	24	0,24	3,36			
K86097600001VTE0	10x10 Dotti Ivory Shower Inclined Edge Internal SIEEI		5,00	6	24	0,24	3,36			
K86100200001VTE0	10x10 Dotti Light Grey Shower Inclined Edge Internal SIEEI		5,00	6	24	0,24	3,36			
K86103500001VTE0	10x10 Dotti Dark Grey Shower Inclined Edge Internal SIEEI		5,00	6	24	0,24	3,36			
K88203500001VTE0	10x10 Uni Grey Shower Inclined Edge Internal SIEEI		5,00	6	24	0,24	3,36			
K88673000001VTE0	10x10 Uni Black Shower Inclined Edge Internal SIEEI		5,00	6	24	0,24	3,36			
K86115300001VTE0	10x10 Color Dot Anthracite Shower Inclined Edge Internal SIEEI		5,00	6	24	0,24	3,36			

10x10 Shower Inclined End Edge (External)

K83701500001VTE0	10x10 Uni Ivory Shower Inclined Edge External SIEEE		5,00	6	24	0,24	3,36			
K86098000001VTE0	10x10 Dotti Ivory Shower Inclined Edge External SIEEE		5,00	6	24	0,24	3,36			
K86101300001VTE0	10x10 Dotti Light Grey Shower Inclined Edge External SIEEE		5,00	6	24	0,24	3,36			
K86104600001VTE0	10x10 Dotti Dark Grey Shower Inclined Edge External SIEEE		5,00	6	24	0,24	3,36			
K84162400001VTE0	10x10 Uni Grey Shower Inclined Edge External SIEEE		5,00	6	24	0,24	3,36			
K94951100001VTE0	10x10 Uni Black Shower Inclined Edge External SIEEE		5,00	6	24	0,24	3,36			
K86116400001VTE0	10x10 Color Dot Anthracite Shower Inclined Edge External SIEEE		5,00	6	24	0,24	3,36			

Plinth

7x30 Plinth

K75230100001VTE0	7x30 Uni Ivory Plinth		3,00	8	30	0,63	11,01			
K75233400001VTE0	7x30 Dotti Ivory Plinth		3,00	8	30	0,63	11,01			
K75234500001VTE0	7x30 Dotti Light Grey Plinth		3,00	8	30	0,63	11,01			
K75235600001VTE0	7x30 Dotti Dark Grey Plinth		3,00	8	30	0,63	11,01			
K75231200001VTE0	7x30 Uni Grey Plinth		3,00	8	30	0,63	11,01			
K75232300001VTE0	7x30 Uni Black Plinth		3,00	8	30	0,63	11,01			
K75864100001VTE0	7x30 Color Dot Anthracite Plinth		3,00	8	30	0,63	11,01			

Step Tread

30x30 Step Tread

K75468100001VTE0	30x30 Uni Ivory Tread		4,00	8	11	1,00	15,95			
K75462200001VTE0	30x30 Dotti Ivory Tread		4,00	8	11	1,00	15,95			
K75463300001VTE0	30x30 Dotti Light Grey Tread		4,00	8	11	1,00	15,95			
K75464400001VTE0	30x30 Dotti Dark Grey Tread		4,00	8	11	1,00	15,95			
K75469200001VTE0	30x30 Uni Grey Tread		4,00	8	11	1,00	15,95			
K75470300001VTE0	30x30 Uni Black Tread		4,00	8	11	1,00	15,95			
K75862600001VTE0	30x30 Color Dot Anthracite Tread		4,00	8	11	1,00	16,17			

Matrix

Product Code Ürün kodu	Product Name Ürün adı	Euro		Thickness (mm) Kalınlık (mm)	Box Kutu		Pallet Palet	
		m ²	Pcs Ad.		Pcs Ad.	m ²	kg	Box Kutu

60x60 Matrix R10A

K944663R0001VTE0	60x60 Matrix Super White Plain R10A 7Rec	38,80		9	4	1,44	26,90	30	43,20	831,98
K944650R0001VTE0	60x60 Matrix Nude Plain R10A 7Rec	38,80		9	4	1,44	26,90	30	43,20	831,98
K944656R0001VTE0	60x60 Matrix Green Plain R10A 7Rec	38,80		9	4	1,44	26,90	30	43,20	831,98
K944647R0001VTE0	60x60 Matrix Tobacco Plain R10A 7Rec	38,80		9	4	1,44	26,90	30	43,20	831,98
K946337R0001VTE0	60x60 Matrix Grey Plain R10A 7Rec	38,80		9	4	1,44	26,90	30	43,20	831,98
K944668R0001VTE0	60x60 Matrix Super Black Plain R10A 7Rec	38,80		9	4	1,44	26,90	30	43,20	831,98
K946937R0001VTE0	60x60 Matrix Silver Plain R10A 7Rec	38,80		9	4	1,44	26,90	30	43,20	831,98

60x60 Matrix Decor

K944660R0001VTE0	60x60 Matrix Super White Geometric 1 R11B 7Rec	42,70		9	4	1,44	26,90	30	43,20	831,98
K944661R0001VTE0	60x60 Matrix Super White Geometric 2 R10B 7Rec	38,80		9	4	1,44	26,90	30	43,20	831,98
K944664R0001VTE0	60x60 Matrix Super White Random 1 R11C 7Rec	42,70		9	4	1,44	26,90	30	43,20	831,98
K944665R0001VTE0	60x60 Matrix Super White Random 2 R11B 7Rec	42,70		9	4	1,44	26,90	30	43,20	831,98
K944639R0001VTE0	60x60 Matrix Nude Geometric 1 R11B 7Rec	42,70		9	4	1,44	26,90	30	43,20	831,98
K944649R0001VTE0	60x60 Matrix Nude Geometric 2 R10B 7Rec	38,80		9	4	1,44	26,90	30	43,20	831,98
K944652R0001VTE0	60x60 Matrix Nude Random 1 R11C 7Rec	42,70		9	4	1,44	26,90	30	43,20	831,98
K944653R0001VTE0	60x60 Matrix Nude Random 2 R11B 7Rec	42,70		9	4	1,44	26,90	30	43,20	831,98
K944654R0001VTE0	60x60 Matrix Green Geometric 1 R11B 7Rec	42,70		9	4	1,44	26,90	30	43,20	831,98
K944655R0001VTE0	60x60 Matrix Green Geometric 2 R10B 7Rec	38,80		9	4	1,44	26,90	30	43,20	831,98
K945035R0001VTE0	60x60 Matrix Green Random 1 R11C 7Rec	42,70		9	4	1,44	26,90	30	43,20	831,98
K944659R0001VTE0	60x60 Matrix Green Random 2 R11B 7Rec	42,70		9	4	1,44	26,90	30	43,20	831,98
K944645R0001VTE0	60x60 Matrix Tobacco Geometric 1 R11B 7Rec	44,00		9	4	1,44	26,90	30	43,20	831,98
K944646R0001VTE0	60x60 Matrix Tobacco Geometric 2 R10B 7Rec	39,00		9	4	1,44	26,90	30	43,20	831,98
K944648R0001VTE0	60x60 Matrix Tobacco Random 1 R11C 7Rec	44,00		9	4	1,44	26,90	30	43,20	831,98
K944658R0001VTE0	60x60 Matrix Tobacco Random 2 R11B 7Rec	44,00		9	4	1,44	26,90	30	43,20	831,98
K946335R0001VTE0	60x60 Matrix Grey Geometric 1 R11B 7Rec	44,00		9	4	1,44	26,90	30	43,20	831,98
K946336R0001VTE0	60x60 Matrix Grey Geometric 2 R10B 7Rec	39,00		9	4	1,44	26,90	30	43,20	831,98
K946338R0001VTE0	60x60 Matrix Grey Random 1 R11C 7Rec	44,00		9	4	1,44	26,90	30	43,20	831,98
K946339R0001VTE0	60x60 Matrix Grey Random 2 R11B 7Rec	44,00		9	4	1,44	26,90	30	43,20	831,98
K944666R0001VTE0	60x60 Matrix Super Black Geometric 1 R11B 7Rec	44,00		9	4	1,44	26,90	30	43,20	831,98
K944667R0001VTE0	60x60 Matrix Super Black Geometric 2 R10B 7Rec	39,00		9	4	1,44	26,90	30	43,20	831,98
K944669R0001VTE0	60x60 Matrix Super Black Random 1 R11C 7Rec	44,00		9	4	1,44	26,90	30	43,20	831,98
K944670R0001VTE0	60x60 Matrix Super Black Random 2 R11B 7Rec	44,00		9	4	1,44	26,90	30	43,20	831,98
K946935R0001VTE0	60x60 Matrix Silver Geometric 1 R11B 7Rec	44,00		9	4	1,44	26,90	30	43,20	831,98
K946936R0001VTE0	60x60 Matrix Silver Geometric 2 R10B 7Rec	39,00		9	4	1,44	26,90	30	43,20	831,98
K946939R0001VTE0	60x60 Matrix Silver Random 2 R11B 7Rec	44,00		9	4	1,44	26,90	30	43,20	831,98
K946938R0001VTE0	60x60 Matrix Silver Random 1 R11C 7Rec	44,00		9	4	1,44	26,90	30	43,20	831,98

30x60 Matrix R10A

K945221R0001VTE0	30x60 Matrix Super White Plain R10A 7Rec	32,40		9	6	1,08	20,10	40	43,20	828,95
K945211R0001VTE0	30x60 Matrix Nude Plain R10A 7Rec	32,40		9	6	1,08	20,10	40	43,20	828,95
K945216R0001VTE0	30x60 Matrix Green Plain R10A 7Rec	32,40		9	6	1,08	20,10	40	43,20	828,95
K945208R0001VTE0	30x60 Matrix Tobacco Plain R10A 7Rec	32,40		9	6	1,08	20,10	40	43,20	828,95
K946342R0001VTE0	30x60 Matrix Grey Plain R10A 7Rec	32,40		9	6	1,08	20,10	40	43,20	828,95
K945226R0001VTE0	30x60 Matrix Super Black Plain R10A 7Rec	32,40		9	6	1,08	20,10	40	43,20	828,95
K946942R0001VTE0	30x60 Matrix Silver Plain R10A 7Rec	32,40		9	6	1,08	20,10	40	43,20	828,95

30x60 Matrix Decor

K945219R0001VTE0	30x60 Matrix Super White Geometric 1 R11B 7Rec	35,70		9	6	1,08	20,10	40	43,20	828,95
K945220R0001VTE0	30x60 Matrix Super White Geometric 2 R10B 7Rec	32,40		9	6	1,08	20,10	40	43,20	828,95
K945222R0001VTE0	30x60 Matrix Super White Random 1 R11C 7Rec	35,70		9	6	1,08	20,10	40	43,20	828,95
K945223R0001VTE0	30x60 Matrix Super White Random 2 R11B 7Rec	35,70		9	6	1,08	20,10	40	43,20	828,95

Product Code Ürün kodu	Product Name Ürün adı	Euro		Thickness (mm) Kalınlık (mm)	Box Kutu		Pallet Palet			
		m ²	Pcs Ad.		Pcs Ad.	m ²	kg	Box Kutu	m ²	kg
K945201R0001VTE0	30x60 Matrix Nude Geometric 1 R11B 7Rec	35,70		9	6	1,08	20,10	40	43,20	828,95
K945210R0001VTE0	30x60 Matrix Nude Geometric 2 R10B 7Rec	32,40		9	6	1,08	20,10	40	43,20	828,95
K945212R0001VTE0	30x60 Matrix Nude Random 1 R11C 7Rec	35,70		9	6	1,08	20,10	40	43,20	828,95
K945213R0001VTE0	30x60 Matrix Nude Random 2 R11B 7Rec	35,70		9	6	1,08	20,10	40	43,20	828,95
K945214R0001VTE0	30x60 Matrix Green Geometric 1 R11B 7Rec	35,70		9	6	1,08	20,10	40	43,20	828,95
K945215R0001VTE0	30x60 Matrix Green Geometric 2 R10B 7Rec	32,40		9	6	1,08	20,10	40	43,20	828,95
K945199R0001VTE0	30x60 Matrix Green Random 1 R11C 7Rec	35,70		9	6	1,08	20,10	40	43,20	828,95
K945218R0001VTE0	30x60 Matrix Green Random 2 R11B 7Rec	35,70		9	6	1,08	20,10	40	43,20	828,95
K945206R0001VTE0	30x60 Matrix Tobacco Geometric 1 R11B 7Rec	35,70		9	6	1,08	20,10	40	43,20	828,95
K945207R0001VTE0	30x60 Matrix Tobacco Geometric 2 R10B 7Rec	32,40		9	6	1,08	20,10	40	43,20	828,95
K945209R0001VTE0	30x60 Matrix Tobacco Random 1 R11C 7Rec	35,70		9	6	1,08	20,10	40	43,20	828,95
K945217R0001VTE0	30x60 Matrix Tobacco Random 2 R11B 7Rec	35,70		9	6	1,08	20,10	40	43,20	828,95
K946340R0001VTE0	30x60 Matrix Grey Geometric 1 R11B 7Rec	35,70		9	6	1,08	20,10	40	43,20	828,95
K946341R0001VTE0	30x60 Matrix Grey Geometric 2 R10B 7Rec	32,40		9	6	1,08	20,10	40	43,20	828,95
K946343R0001VTE0	30x60 Matrix Grey Random 1 R11C 7Rec	35,70		9	6	1,08	20,10	40	43,20	828,95
K946344R0001VTE0	30x60 Matrix Grey Random 2 R11B 7Rec	35,70		9	6	1,08	20,10	40	43,20	828,95
K945224R0001VTE0	30x60 Matrix Super Black Geometric 1 R11B 7Rec	35,70		9	6	1,08	20,10	40	43,20	828,95
K945225R0001VTE0	30x60 Matrix Super Black Geometric 2 R10B 7Rec	32,40		9	6	1,08	20,10	40	43,20	828,95
K945197R0001VTE0	30x60 Matrix Super Black Random 1 R11C 7Rec	35,70		9	6	1,08	20,10	40	43,20	828,95
K945198R0001VTE0	30x60 Matrix Super Black Random 2 R11B 7Rec	35,70		9	6	1,08	20,10	40	43,20	828,95
K946940R0001VTE0	30x60 Matrix Silver Geometric 1 R11B 7Rec	35,70		9	6	1,08	20,10	40	43,20	828,95
K946941R0001VTE0	30x60 Matrix Silver Geometric 2 R10B 7Rec	32,40		9	6	1,08	20,10	40	43,20	828,95
K946943R0001VTE0	30x60 Matrix Silver Random 1 R11C 7Rec	35,70		9	6	1,08	20,10	40	43,20	828,95
K946944R0001VTE0	30x60 Matrix Silver Random 2 R11B 7Rec	35,70		9	6	1,08	20,10	40	43,20	828,95
60x60 Matrix Flake										
K947056R0001VTE0	60X60 Matrix Flake Grey Matt 7Rec	32,00		9	4	1,44	26,93	30	43,20	832,84
K947057R0001VTE0	60X60 Matrix Flake Black Matt 7Rec	32,00		9	4	1,44	26,93	30	43,20	832,84
K947055R0001VTE0	60X60 Matrix Flake White Matt 7Rec	35,00		9	4	1,44	26,93	30	43,20	832,84
K947059R0001VTE0	60X60 Matrix Color Flake Grey (Nude-Tobacco) R10 7Rec	33,00		9	4	1,44	26,93	30	43,20	832,84
K947060R0001VTE0	60X60 Matrix Color Flake Black (White-Green) R10 7Rec	33,00		9	4	1,44	26,93	30	43,20	832,84
K947058R0001VTE0	60X60 Matrix Color Flake White (Nude-Tobacco) R10 7Rec	36,00		9	4	1,44	26,93	30	43,20	832,84
30x60 Matrix Flake										
K947124R0001VTE0	30x60 Matrix Flake Grey Matt 7Rec	31,00		9	6	1,08	20,10	40	43,20	828,95
K947125R0001VTE0	30x60 Matrix Flake Black Matt 7Rec	31,00		9	6	1,08	20,10	40	43,20	828,95
K947123R0001VTE0	30x60 Matrix Flake White Matt 7Rec	34,00		9	6	1,08	20,10	40	43,20	828,95
K947127R0001VTE0	30x60 Matrix Color Flake Grey (Nude-Tobacco) R10 7Rec	32,00		9	6	1,08	20,10	40	43,20	828,95
K947128R0001VTE0	30x60 Matrix Color Flake Black (White-Green) R10 7Rec	32,00		9	6	1,08	20,10	40	43,20	828,95
K947126R0001VTE0	30x60 Matrix Color Flake White (Nude-Tobacco) R10 7Rec	35,00		9	6	1,08	20,10	40	43,20	828,95
30x30 Matrix Flake										
K94418700001VTE0	30x30 Matrix Flake Grey R9	21,80		8	11	1,00	16,14	60	60,00	993,40
K94418800001VTE0	30x30 Matrix Flake Black R9	21,80		8	11	1,00	16,14	60	60,00	993,40
K94379200001VTE0	30x30 Matrix Flake White R9	24,00		8	11	1,00	16,14	60	60,00	993,40
K94419200001VTE0	30x30 Matrix Flake Grey R9 12mm	28,40		12	11	1,00	25,35	38	38,00	988,30
K94379300001VTE0	30x30 Matrix Flake White R9 12mm	31,20		12	11	1,00	25,35	38	38,00	988,30
K94419000001VTE0	30x30 Matrix Flake Grey R10	22,90		8	11	1,00	16,14	60	60,00	993,40
K94419100001VTE0	30x30 Matrix Flake Black R10	22,90		8	11	1,00	16,14	60	60,00	993,40
K94418900001VTE0	30x30 Matrix Flake White R10	25,20		8	11	1,00	16,14	60	60,00	993,40
K94639800001VTE0	30x30 Matrix Color Flake Grey (Nude-Tobacco) R10	29,30		8	11	1,00	16,14	60	60,00	993,40
K94639900001VTE0	30x30 Matrix Color Flake Black (White-Green) R10	29,30		8	11	1,00	16,14	60	60,00	993,40
K94639700001VTE0	30x30 Matrix Color Flake White (Nude-Tobacco) R10	32,20		8	11	1,00	16,14	60	60,00	993,40

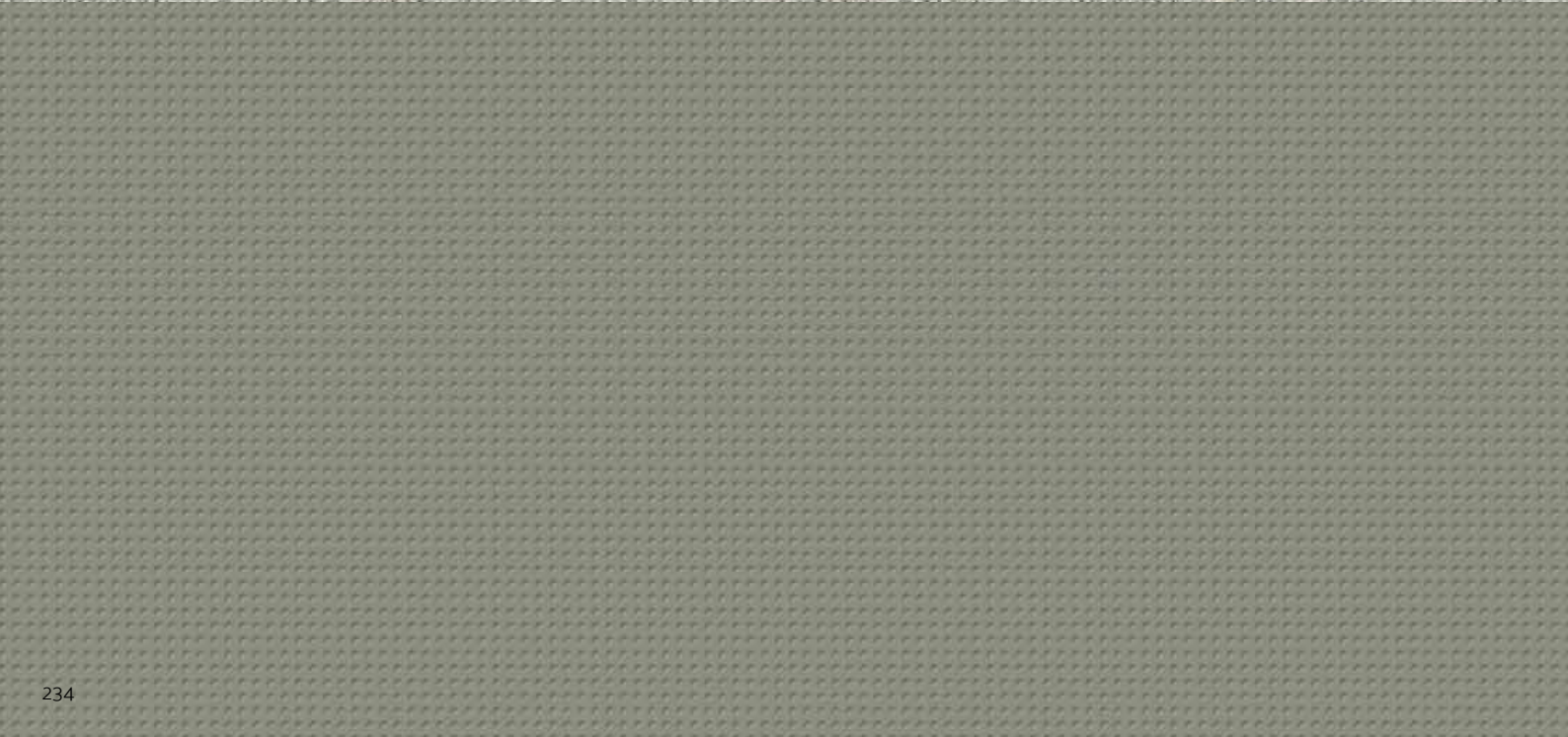
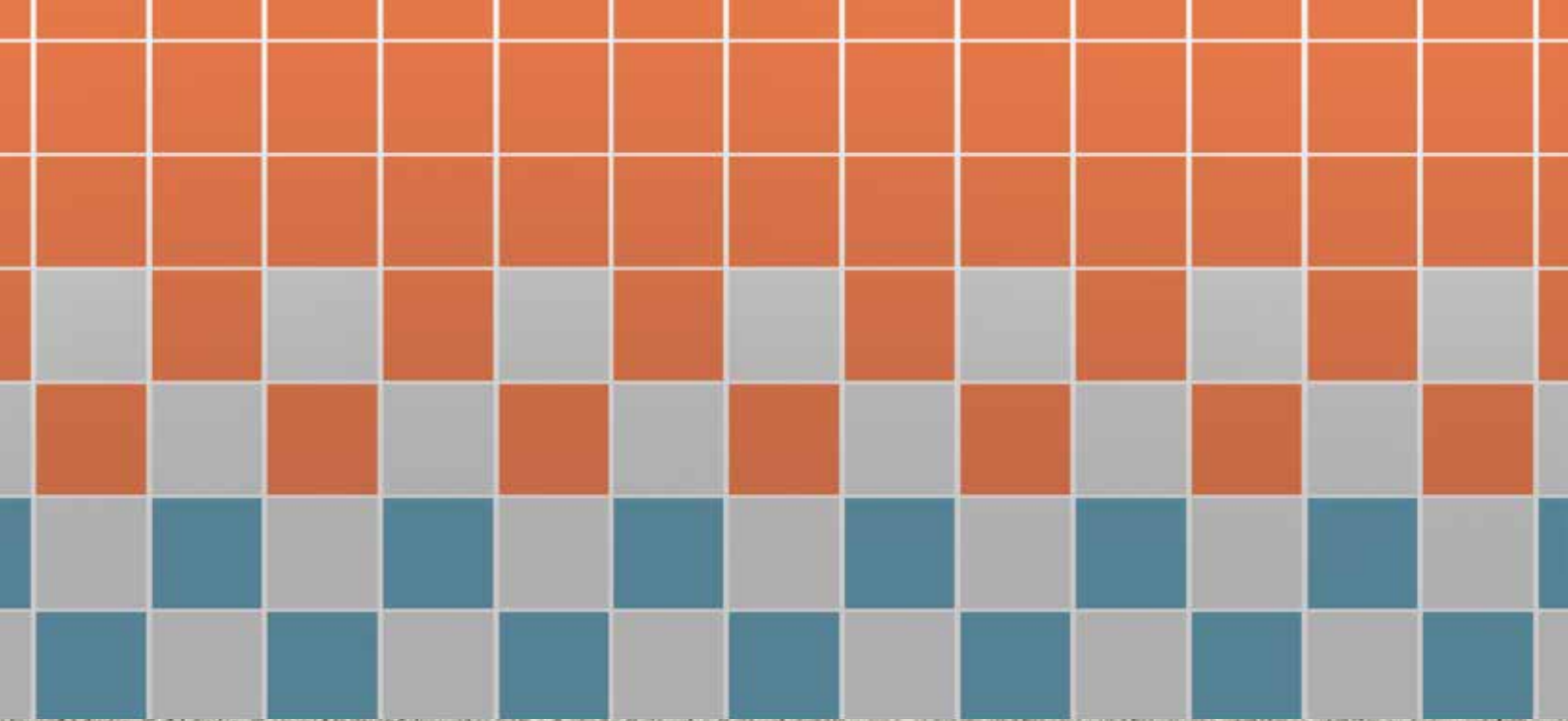

Technical information

Teknik bilgiler

Mesh mountings / Fileleme

For simpler and faster laying, easier mosaic creation, colour combinations and the special requirements of wet areas, tiles can be pre-glued at the factory to make easy-to-lay laid 297 x 297 mm tile mats of small format tiles. In addition to traditional plastic mesh mounting, VitrA's innovative new dot mounting method fixes tiles together at the sides with dots of adhesive. Dot mounted tiling is unaffected by water and remains firm even in the most demanding environments - its advantages are superior water resistance, improved bonding with underlying surfaces, and precise joints.

Benefits of dot mounting and plastic mesh mounting:

- Simpler and faster to lay
- Easier to create mosaics
- Colour combinations

Advantages of dot mounting compared to plastic mesh method:

- Water resistant
- Improved bonding with the underlying surface
- Precise joints

Top net or dot mount net application is recommended for wet spaces

***All products varying from 2.5 x 2.5 to 10 x 10 have plastic mesh mounting as a standard and all codes in the catalog refer to plastic mesh codes. If a different mesh type is requested, the following changes should be made in the codes, on the digit before "0"; for dot mounting "7" instead of 8.

Özellikle ıslak mekânlar için küçük ebatlı karolar 297 x 297 mm ebadında levhalar oluşturacak şekilde filelenir. Geleneksel naylon filenin yanı sıra yeni bir teknoloji ile üretilen "dot mounting" fileleme yöntemi ayrıca isteğe bağlı olarak önden naylon fileleme de uygulanabilir. "Dot Mounting" seçeneğinde karolar polyester katkılı bir malzeme ile noktalar halinde birleştirilir; bu sayede fileli karolar hem dış mekânda, hem de ıslak ortamlarda rahatlıkla kullanılabilir.

Dot Mounting ve naylon filenin avantajları:

- Basit, hızlı döşeme
- Mozaiklerin daha kolay tasarlanması
- Renk kombinasyonları

Dot Mounting'in naylon fileye göre avantajları:

- Sudan etkilenmez
- Yüksek yapışma mukavemeti
- Tam ölçüsünde derz kesimi

Islak alanlar için üstten file ve dot mount file uygulaması önerilir.

***2.5x2.5'dan 10x10'a kadar tüm ürünlerimiz standart olarak naylon filelidir. Katalog içerisindeki tüm kodlar naylon file kodlarıdır. Farklı file tiplerinin talep edilmesi durumunda kodların "0'dan" önceki hanesine; dot mount file için 8 yerine 7 koyarak kod değişimi ile sipariş girişi yapılmalıdır.



VitrA Clean

VitrA Clean is a surface finish that makes VitrA tiles and sanitaryware products incredibly easy to care for. This special glazing process increases surface tension, meaning water and soil flows easily from the surface. All that's needed to keep surfaces clean is a wipe with a damp cloth and the use of a mild cleanser, providing long-term time savings, both in residential and commercial environments. (VitrA Clean is available as an option on Color series from PRO TECHNIC range wall tiles.)

* Can be applied to all PRO Color wall tiles.

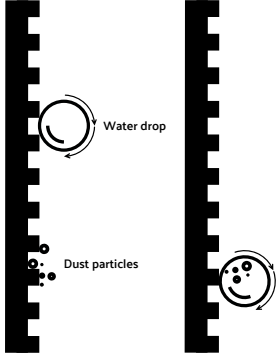

VitrA Clean, VitrA'nın karo ve ıslak mekân ürünlerini daha kolay temizlenebilir kılan modern bir yüzey zenginleştirme yöntemidir. Özel sırlama yöntemi yüzey gerilimini artırır. Böylece su, yüzey üzerinde cıva gibi hareket ederek kirin kolaylıkla yüzeyden ayrılmasını sağlar. Ürün yüzeyleri sadece suyla, nemli bir bezle veya gerektiği takdirde yumuşak temizleme maddeleriyle temizlenebilir. Bu kalıcı özellik hem profesyonel, hem de özel kullanım alanlarının temizliğinde kullanıcılara büyük kolaylıklar sağlamaktadır. VitrA Clean, istek üzerine PRO TECHNIC koleksiyonu içindeki Color serisi duvar karolarına da uygulanabilir.

* Duvarda kullanılacak tüm PRO Color ürünlerine uygulanabilir.

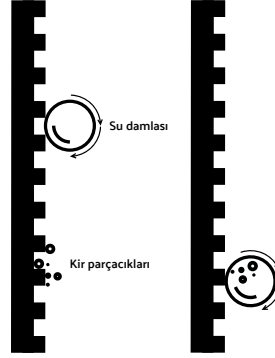

VitrA Shield

VitrA Shield is an application of nano titanium dioxide (TiO₂) coating on tiles. VitrA Shield can be applied on all kinds of tiles for indoor and outdoor use.

VitrA Shield tiles are self-cleaning thanks to the photocatalytic features activated by light and humidity in the air, while ensuring biocidal protection with their hygienic properties. The advanced technology of VitrA Shield eliminates unpleasant smells and airborne pollutants in spaces where the tiles are used.



VitrA Shield uygulaması ile karolar nano titanyum dioksit (TiO₂) ile kaplanır. VitrA Shield iç ve dış mekân kullanımına uygun tüm karolara uygulanabilir.

VitrA Shield karolar, ışık ve havadaki nem ile aktive olan fotokatalitik özellikleri sayesinde kendi yüzeylerini temizlerken hijyen özellikleriyle de biyosidal koruma sağlar. VitrA Shield kullanıldığı mekânlarda ileri teknoloji sayesinde kötü kokuların ve havadaki zararlı bileşenlerin etkisini azaltır.



VitrA Block

Watermark is a general problem occurring on white wall tiles due to water absorption. Wall tiles with VitrA Block Watermark-Free Technology have very low water absorption and therefore show no sign of watermark on the surface.

VitrA Block Watermark-Free Technology improves the performance of tile for the watermark problem and ensures customers satisfaction. A new engobe recipe has been developed with 0% water absorption without making any change on body recipe, firing cycle and tiling. Material science, chemical disciplines and microstructure characterization techniques were used to develop the innovative VitrA Block Watermark-Free Technology.



Su lekeleri, su emilimine bağlı olarak beyaz duvar karolarında karşılaşılan genel bir sorundur. VitrA Block Su Lekesi Göstermeyen Teknoloji ile üretilen duvar karoları, su emicilikleri son derece düşük olduğundan yüzeylerde su lekesi izi bırakmaz.

VitrA Block Su Lekesi Göstermeyen Teknoloji, karolarda yaşanan su lekesi sorununu ortadan kaldırarak müşteri memnuniyetini artırır. Karoların hazırlama, fırınlama ve döşeme süreçlerinde herhangi bir değişikliğe gidilmeden %0 su emiciliği sağlayan yeni bir astar formülü keşfedilmiştir. Yenilikçiliği ile çığır açan VitrA Block Su Lekesi Göstermeyen Teknoloji; malzeme mühendisliği, kimya bilimi ve mikroyapı karakterizasyon teknikleri kullanılarak geliştirilmiştir.



Color wear resistance (PEI) and light reflection values
 Color aşınma dirençleri (PEI) ve kontrastlık değerleri (LRV)









PRO Color	PEI		LRV	
	Matt Mat	Glossy Parlak	Matt Mat	Glossy Parlak
RAL 9016	4	3	77,8	79,5
RAL 0001500	2	2	5,5	4,8
RAL 1105050	3	2	23,4	22,9
RAL 1008080	3	2	52,4	52,8
RAL 0808060	3		56,4	55,9
RAL 1018		3	60,9	59,2
RAL 0757070	3	2	44,9	45,1
RAL 2003	2		30,8	
RAL 2010		2	25,7	25,3
RAL 0304050	2		13,4	
RAL 3000		2		14
RAL 2008020	3	2	50,8	50,5
RAL 2006020	3	2	29	29,1
RAL 2004030	2	2	14,9	15,2
RAL 2307015	4	3	48,2	48
RAL 2306020	3		30,4	
RAL 2404020	2	2	13,6	13,8
RAL 2606030	3	2	28	27,9
RAL 2603035	2	2	13,4	13,9
RAL 5002	2	2	8	5,5
RAL 1009005	4	3	70,9	73,1
RAL 0809005	4	3	74,1	72,8
RAL 0809010	4	3	66	66,8
RAL 0808010	4		54,1	
RAL 0958010	4	3	57,2	57,9
RAL 0007500	3	2	43,8	42
RAL 0806005	3	2	29,3	
RAL 0505010	3	2	18	17,2
RAL 7047	4	3	61,9	59,9
RAL 8000	3		48,8	
RAL 0005500	3	2	28,3	28,7
RAL 0004000	2	2	11	10,9
RAL 3004	2		8,2	8,4
RAL 0504040	2	2	17,4	17,6
RAL 0706040	3	2	25,8	
RAL 2904015	2	2	10,9	10,9
RAL 0404005	2	2	14,5	
RAL 0606020	2	2	34,3	
RAL 0206005	3	2	28,5	28
RAL 1007010	4	2	36,9	37,9
RAL 2205005	2	2	17,2	17,6

The closest ral equivalents of Uni colors

Uni renkler için en yakın RAL karşılıkları

Super white / Süper beyaz	RAL 090 90 10
Ivory / Fildişi	RAL 070 80 10
Dark mink / Koyu vizon	RAL 060 50 05
Cement grey / Çimento gri	RAL 100 70 05
Grey / Gri	RAL 000 55 00
Black / Siyah	RAL 000 40 00
Silver / Gümüş	RAL 140 80 05

Symbols / Semboller

 Floor tile Yer karosu	 Frost resistant Dona dayanım	 Colour fast Rengi solmaz	 Glass Cam	 Matt Mat	 V ₀ Shade variation Desen farklılaşması	 Porcelain Porselen	 PEI 1 Abrasion Aşınma	 Facade Dış cephe	 Outdoors Dış mekânlar
 Wall tiles Duvar karosu	 Flame resistance Ateşe dayanıklı	 Salt resistance Tuzlu suya dayanıklı	 Rectified Rektifiyeli	 Glossy Parlak	 V ₁ Shade variation Desen farklılaşması	 Full lappato	 PEI 2 Abrasion Aşınma	 Residential Konut	 Park & garden Bahçe ve parklar
 Novelties Yeni	 Thermal resistance Isı farkına dayanıklı	 Break resistance Yüke dayanıklı	 Rectified Rektifiyeli	 Satine Saten	 V ₂ Shade variation Desen farklılaşması	 Lappato	 PEI 3 Abrasion Aşınma	 Industrial area Endüstriyel alan	 Laying on sand Plaj ve kum zeminler
 Award winning Ödüllü	 Accessible and reusable Serbest döşeme ile söküp taşınabilir	 Easy to clean Kolay temizlenir	 Reactive ink Reaktif ink	 Soft r10	 V ₃ Shade variation Desen farklılaşması	 R9 lappato	 PEI 4 Abrasion Aşınma	 Pool and spa Havuz çevresi ve spa	
 Huge dimension Büyük ebat	 Easy tiling Kolay döşenir	 Resistant to domestic chemicals Evsel kimyasallara dayanıklı	 Metalic glaze Metalik sır	 Metro	 V ₄ Shade variation Desen farklılaşması		 PEI 5 Abrasion Aşınma	 Commercial Ticari alanlar	
 Thickness Kalınlık	 The raised paving system Yükseltilmiş döşemeye uygun	 Moss and rust resistance Yosun ve pas oluşturmaz	 Decor printing Dekor baskı	 Bumpy				 Parking areas Garajlar ve otomobil galerileri	
 Mini size Küçük ebat	 Modularity Modülerlik	 Vitra SHIELD Vitra Shield	 Self-cleaning Kendi kendine temizleme	 Hygienic effect Hiyjenik etki					
 Vitra SLIM Vitra Slim		 Vitra BLOCK Vitra Block	 Photoactive Fotokatalitik etki	 Protection from airborne pollutants Havadaki kirlere karşı koruma kalkanı					

reaLook TECHNOLOGY

World's most advanced printing facilities are combined with Vitra's exquisite design competence. With Vitra's exclusive reaLook Printing technology, images can be reflected on the tiles in such a way that they are indistinguishable from natural.

(1) Dünyanın en ileri baskı olanakları Vitra'nın üstün tasarım yetkinliği ile birleşiyor. Vitra'ya özgü reaLook Baskı teknolojisi ile görüntüler, karo üzerinde, doğala en yakın dokularla ve görsellikle yansıtılıyor.

(1) Only if required by corresponding national statutory regulations / Sadece ilgili ülke mevzuatında gereklirse

Shade variation

Tiles may vary in colour, texture or appearance according to product design for particular tile collections. Especially Shade variation V3, V4 type products may vary significantly within boxes, samples, merchandising and display. It is strongly recommended to pay attention to Shade variation during product selection. VitrA has five groups with different variation intensity that are indicated on the catalogues for specific products.

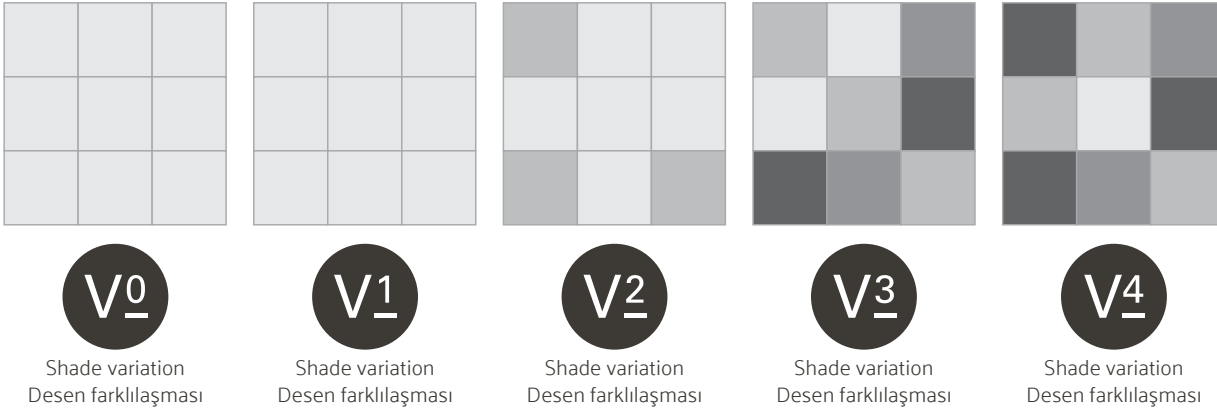

V0- very uniform appearance

Pieces of the same shade value are very uniform and smooth in texture.

V1- uniform appearance

Minor variations in colour and structure for a restful, natural effect.

V2- slight variation

Clearly, distinguishable differences in texture and/or pattern within similar colours.

V3- moderate variation

While the colour and/or texture on a single piece of tile could be indicative of the colour and/or texture on the other tiles, the amount of colour and/or texture variation on each piece may be significant.

V4- substantial variation

Random colour and/or texture differences from tile to tile, so that one tile may have totally different colour and/or texture from that on other tiles. Thus, the final installation will be unique.

Desen farklılaşması

Karolar, belirli koleksiyonlar özelinde kendi içerisinde ürün tasarımına göre renk, doku veya görünüm olarak değişiklik gösterir. Özellikle Desen farklılaşması V3, V4 tipi ürünler; kutular, numuneler, ticari ürünler ve gösterimler arasında önemli ölçüde değişiklik gösterebilir. Ürün seçimi sırasında Desen farklılaşmasına dikkat etmeniz önerilir. Vitra karolarda, belirli ürünler için kataloglarda belirtilen beş desen farklılaşma sınıflandırması bulunmaktadır.

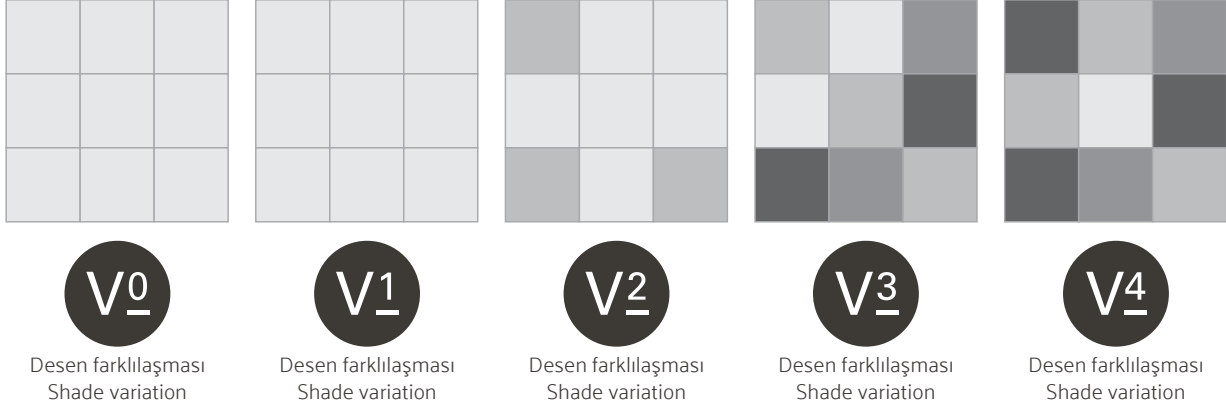

V0- tekdüze görünüm

Karolar arasında önemsiz farklılıklarla her bir karo aynı renge, tona sahiptir.

V1- hafif farklı görünüm

Doğal bir etki için karonun kendi içinde ve karolar arasında küçük renk farklılıkları mevcuttur.

V2- farklı Görünüm

Benzer renklerde doku ve / veya desende gözle fark edilebilir farklılıklar mevcuttur.

V3- çok Farklı Görünüm

Karolar arasında ve/veya tek bir karo üzerindeki renk ve/veya doku farklılaşması önemli miktardadır.

V4- rastgele Farklı Görünüm

Karodan karoya renk ve/veya dokuda rastgele dağılım mevcuttur. Bu sebeple bir karo diğerinden tamamen farklı renk ve/veya dokuda olabilir. Sonuçta ürünlerin döşenmesi sonucu çıkan görünüm benzersiz olacaktır.

VitrA product code system

VitrA product codes have been renewed in January 2019 in order to achieve a better and more systematic product management structure. The new 16-digits code system helps us to achieve a much better inventory management, error-free planning and easier packaging. The new system also enables more flexible market specific solutions and helps us to eliminate potential customer complaints.

The new product code structure:

Digits	1	2-7	8-11	12	13-14	15	16
Code	K	947186	R000	1	VT	E	0
Description	Standard	Root code	Operation (R, FLPR,...)	Quality	Brand, box	Pallet type	Packaging revisions
Sample	K947186R0001VTE0						

- Digits 1 through 7 represent the root code of the product (In the old code structure format).
- Digits 8 through 11 represent post firing operations. (surface treatments, edge treatments, mesh type and production type, etc.) (FLP: Full lappato, H: Honed touch, FA: Photoactive, S: Shield, etc.)
- 12th digit represents product quality. (1st quality, 2nd quality and end of series product)
- Digits between 13 and 14 represent the boxing or branding of the product. (VT: VitrA KE: Kermos, etc.)
- The 15th digit represents the pallet used during the shipment of the product. (E: Euro pallet, S: Special pallet, etc.)
- The 16th digit represents any revision made in the packaging of the product. (0-9)

Post firing operation codes:

Feature	Explanation	Abbreviation
Production type	Extruder	E
Mesh type	No mesh	O
Mesh type	Paper mesh	4
Mesh type	Top mesh	5
Mesh type	Dot Mount	7
Mesh type	Nylon mesh	8
Mesh type	Polyurethane mesh	9
Glazed edge	Glazed short edge	JJ
Glazed edge	Glazed long edge	JL
Glazed edge	Glazed both edges	JD
Surface treatment	Polish / Protect	P
Surface treatment	Lappato	LP
Surface treatment	Fulllappato	FLP
Surface treatment	Honedtouch	H
Surface technology	Polished after firing	R
Surface technology	Block	B
Surface technology	Hygiene	A
Surface technology	Clean	C
Surface technology	Photoactive	FA
Surface technology	Shield	S
Surface technology	New glow in the dark technology	G
Edge treatment	Rectified	R

VitrA ürün kod sistemi

Daha iyi ve daha sistematik bir ürün yönetimi yapısına ulaşmak için VitrA ürün kodları Ocak 2019'da yenilenmiştir. Yeni 16 basamaklı kod sistemi, çok daha iyi bir envanter yönetimi, hatasız planlama ve daha kolay bir paketleme yönetimi yürütmemize yardımcı oluyor. Yeni sistem ayrıca pazara özel daha esnek çözümler sunabilmemizi ve olası müşteri şikayetlerini ortadan kaldırmamızı sağlıyor.

Yeni ürün kodu yapısı:

Basamaklar	1	2-7	8-11	12	13-14	15	16
Kod	K	947186	R000	1	VT	E	0
Açıklama	Standart	Kök kod	İşlem (R, FLPR,...)	Kalite	Marka, kutu	Palet tipi	Paketleme değişiklikleri
Örnek	K947186R0001VTE0						

- 1 ile 7 arasındaki haneler ürünün kök kodunu (eski kod yapısı formatında) temsil etmektedir.
- 8 ile 11 arasındaki haneler fırın çıkışı uygulamaları temsil etmektedir. (Yüzey işlemleri, kenar işlemleri, file tipi ve üretim tipi vb.) (FLP: Full lappato, H: Honed touch, FA: Photoactive, S: Shield, vb.)
- 12. hane ürün kalitesini temsil etmektedir. (1. kalite, 2. kalite ve seri sonu ürün)
- 13 ile 14 arasındaki haneler ürünün kutu markasını temsil etmektedir. (VT: VitrA KE: Kermos, vb.)
- 15. hane ürünün sevki esnasında kullanılan paleti temsil etmektedir. (E: Europalet, S: Özel palet, vb.)
- 16. hane ürünün paketlemesinde bir değişiklik yapılmak istendiğinde yapılan değişikliği temsil etmektedir. (0-9)

Fırın çıkışı uygulama kodları:

Özellik	Açıklama	Kısaltma
Üretim tipi	Extruder	E
File tipi	Filesiz	O
File tipi	Kağıt File	4
File tipi	Üstten File	5
File tipi	Dot Mount	7
File tipi	Naylon File	8
File tipi	Poliüretan File	9
Kenar sırlı	Kısa veya (kare için) tek kenarı sırlı	JJ
Kenar sırlı	Uzun kenarı sırlı	JL
Kenar sırlı	İki kenarı sırlı	JD
Yüzey işlem	Parlatma / Protect	P
Yüzey işlem	Lappato	LP
Yüzey işlem	Fulllappato	FLP
Yüzey işlem	Honedtouch	H
Yüzey teknoloji	Fırın çıkışı parlak	R
Yüzey teknoloji	Block	B
Yüzey teknoloji	Hijyen	A
Yüzey teknoloji	Clean	C
Yüzey teknoloji	Fotoactive	FA
Yüzey teknoloji	Shield	S
Yüzey teknoloji	Yeni glow in the dark teknolojsi	G
Kenar işlem	Rektifiye	R

Technical characteristics / Teknik özellikler

Technical characteristics Teknik özellikler Technische eigenschaften Caractéristiques techniques	Test standard Test metodu Prüfung nach Méthode du test	Porcelain body Unglazed / Sırsız / Unglasierte / Non émaillés		Porcelain body Glazed / Sırlı / Glasierte / Émaillés		Floor tile body Glazed / Sırlı / Glasierte / Émaillés		Floor tile body Glazed / Sırlı / Glasierte / Émaillés		Wall tile body Glazed / Sırlı / Glasierte / Émaillés	
		EN 14411 Group Bla Annex G		EN 14411 Group Bla Annex G		EN 14411 Group Blb Annex H		EN 14411 Group Blla Annex J		EN 14411 Group Bill Annex L	
		Nominal size ≥ 15cm		Nominal size ≥ 15cm		Nominal size ≥ 15cm		Nominal size ≥ 15cm		Nominal size ≥ 15cm	
Dimension and surface quality / / Ebat ve yüzey kalitesi											
Length and width / Uzunluk ve genişlik / Länge und breite / Longueur et largeur	EN ISO 10545-2	± 0,6%	± 2mm	± 0,6%	± 2mm	± 0,6%	± 2mm	± 0,6%	± 2mm	± 0,5 %	± 2mm
Thickness / Kalınlık / Dicke / Epaisseur	EN ISO 10545-2	± 5%	± 0,5mm	± 5%	± 0,5mm	± 5%	± 0,5mm	± 5%	± 0,5mm	+ 10%	± 0,5mm
Thickness / Kalınlık / Dicke / Epaisseur	EN ISO 10545-2	± 0,5%	± 1,5mm	± 0,5%	± 1,5mm	± 0,5%	± 1,5mm	± 0,5%	± 1,5mm	+ 0,3%	± 1,5mm
Thickness / Kalınlık / Dicke / Epaisseur	EN ISO 10545-2	± 0,5%	± 2mm	± 0,5%	± 2mm	± 0,5%	± 2mm	± 0,5%	± 2mm	± 0,5%	± 2mm
Thickness / Kalınlık / Dicke / Epaisseur	EN ISO 10545-2	± 0,5%	± 2mm	± 0,5%	± 2mm	± 0,5%	± 2mm	± 0,5%	± 2mm	± 0,5% - 0,3 %	± 2mm -1,5mm
Surface quality / Yüzey kalitesi / Oberflächenbeschaffenheit / Qualité de surface	EN ISO 10545-2	Min. 95%		Min. 95%		Min. 95%		Min. 95%		Min. 95%	
Physical properties / Fiziksel özellikler											
Water absorption / Su emme / Wasseraufnahme / Absorption d'eau	EN ISO 10545-3	± 0,5%		± 0,5%		0,5% < E ≤ 3,0%		3,0% < E ≤ 6,0%		E > 10%	
Modulus of rupture / Eğilme dayanımı / Biegefestigkeit / Résistance à la flexion	EN ISO 10545-4	Min. 35 N/mm ²		Min. 35 N/mm ²		Min. 30 N/mm ²		Min. 22 N/mm ²		Min. 15 N/mm ²	
Breaking strength / Kırılma dayanımı / Bruchlast / Force de rupture	EN ISO 10545-4	Min.1300 N (≥7,5mm) Min. 700 N (<7,5mm)		Min.1300 N (≥7,5mm) Min. 700 N (<7,5mm)		Min. 1100 N (≥7,5mm) Min. 700 N (<7,5mm)		Min. 1000 N (≥7,5mm) Min. 600 N (<7,5mm)		Min.600N (≥7,5mm) Min.200N (<7,5mm)	
Surface abrasion / Yüzey aşınma / Widerstand gegen oberflächenverschleiß / Résistance à l'abrasion pei	EN ISO 10545-7	N.A.		As specified in the catalogue / Katalogdaki gibi		As specified in the catalogue / Katalogdaki gibi		As specified in the catalogue / Katalogdaki gibi		Not intended to be used on the floor / Zeminde kullanılmamalıdır	
Deep abrasion / Derin aşınma / Widerstand gegen tiefenverschleiß / Résistance à l'abrasion profonde	EN ISO 10545-6	Max. 175 mm ³		N.A.		N.A.		N.A.		N.A.	
Linear thermal expansion / Lineer ısı genleşme / Linearer wärmeausdehnungs koeffizient / Coeff. de dilatation therm. maxi	EN ISO 10545-8	Max 9 x 10 ⁻⁶ K ⁻¹		Max 9 x 10 ⁻⁶ K ⁻¹		Max 9 x 10 ⁻⁶ K ⁻¹		Max 9 x 10 ⁻⁶ K ⁻¹		Max 9 x 10 ⁻⁶ K ⁻¹	
Thermal shock resistance / Isı şokuna dayanım / Temperaturwechselbeständigkeit / résistance aux écarts de température	EN ISO 10545-9	Pass / Başarılı Erreicht / Conforme		Pass / Başarılı Erreicht / Conforme		Pass / Başarılı Erreicht / Conforme		Pass / Başarılı Erreicht / Conforme		Pass / Başarılı Erreicht / Conforme	
Frost resistance / Don dayanımı / Frostbeständigkeit / Résistance au gel	EN ISO 10545-12	Pass / Başarılı Erreicht / Conforme		Pass / Başarılı Erreicht / Conforme		Pass / Başarılı Erreicht / Conforme		NPD		----	
Coefficient of friction / Sürtünme katsayısı / Reibungskoeffizient / Résistance à la glissance	Declared test method Beyan edilen metod Angabe prüfverfahren	As specified in the catalogue		As specified in the catalogue / Katalogdaki gibi		As specified in the catalogue / Katalogdaki gibi		As specified in the catalogue / Katalogdaki gibi		Not intended to be used on the floor / Zeminde kullanılmamalıdır	
Crazing resistance / Sırlı karolarda çatlamaya dayanım / Widerstand gegen glassurrisse Résistance au tressailage	EN ISO 10545-11	-----		Pass / Başarılı Erreicht / Conforme		Pass / Başarılı Erreicht / Conforme		Pass / Başarılı Erreicht / Conforme		Pass / Başarılı Erreicht / Conforme	
Reaction to fire / Ateşe dayanıklılık / Reaktion gegenüber feuer / Réaction au feu	-----	Class A1 or A1 _{FL}		Class A1 or A1 _{FL}		Class A1 or A1 _{FL}		Class A1 or A1 _{FL}		Class A1 or A1 _{FL}	
Small colour differences for plain coloured tiles / Tek renkli karolarda küçük renk farklılıkları / Farbabweichungen zwischen einfarbig glasierten keramischen fliesen und platten / De faibles différences de couleur entre carreaux céramiques de couleur unie	EN ISO 10545-16	ΔE < 1,0		ΔE < 0,75		ΔE < 0,75		ΔE < 0,75		ΔE < 0,75	
Chemical resistance / Kimyasal dayanım											
Staining resistance / Lekelenmeye dayanım / Fleckbeständigkeit / Résistance aux taches	EN ISO 10545-14	Test method Avaliable Test metodu bulunur Prüfverfahren Vorhanden Méthode d'essai Applicable		Min. Class / Sınıf 3 Klasse / Classe 3		Min. Class / Sınıf 3 Klasse / Classe 3		Min. Class / Sınıf 3 Klasse / Classe 3		Min. Class / Sınıf 3 Klasse / Classe 3	
Resistance to household chemicals and swimming pool water cleaners / Ev kimyasalları ve yüzme havuzu temizleyicilerine dayanım / Beständigkeit gegen haushaltschemikalien und badewasserzusätze / Résistance aux Produits ménagers	EN ISO 10545-13	Class / Sınıf Klasse / Classe Min. B		Class / Sınıf Klasse / Classe Min. B		Class / Sınıf Klasse / Classe Min. B		Class / Sınıf Klasse / Classe Min. B		Class / Sınıf Klasse / Classe Min. B	
Resistance to low concentrations acids&alkalis / Düşük konsantrasyonlu asit ve alkali dayanımı / Beständigkeit gegen säuren und laugen mit niedriger konzentration / Résistance aux produits bas concentration acides et bases	EN ISO 10545-13	Class / Sınıf Klasse / Classe LA-LC		Class / Sınıf Klasse / Classe LA-LC		Class / Sınıf Klasse / Classe LA-LC		Class / Sınıf Klasse / Classe LA-LC		Class / Sınıf Klasse / Classe LA-LC	
Resistance to high concentrations acids&alkalis / Yüksek konsantrasyonlu asit ve alkali dayanımı / Beständigkeit gegen säuren und laugen mit hoher konzentration / Résistance Aux produits haut concentration ücides et bases	EN ISO 10545-13	Class / Sınıf Klasse / Classe HA-HC		Class / Sınıf Klasse / Classe HA-HC		Class / Sınıf Klasse / Classe HA-HC		Class / Sınıf Klasse / Classe HA-HC		Class / Sınıf Klasse / Classe HA-HC	

VitrA tiles conforms to EN 14411 Standard requirements which are specified in the related product groups with better values. All references to as well as quotations from product and test standards are to be considered as information which is not binding. The latest versions apply. / Garanti koşulları, temizlik ve bakım talimatları, teknik özellikler ile ilgili son bilgileri PRO Nature kataloğundan bulabilirsiniz. / VitrA-Fliesen entsprechen den EN 14411 Standardanforderungen, die in den zugehörigen Produktgruppen mit besseren Werten angegeben sind. / Alle Verweise sowie Zitate aus Produkt- und Prüfnormen sind als unverbindliche Informationen zu betrachten. Die neuesten Versionen gelten. 14.08.2018 Rev: 01

CE marking – declaration of performance and VOC label

The CE marking indicates that a construction product conforms its declared performance and it has been assessed according to a harmonised European standard. The CE mark is the safety product certification required by EU and it is finalized to preserve the people's health and the goods in buildings. The CE marking of the Vitra products is prepared according to the Annex V of the Regulation (EU) No 305/2011 (amended by Delegated Regulation EU No 568/2017)



All the declaration of performances of the Vitra products are prepared according to model provided in Delegated Regulation EU No 574/2014. Ceramic tiles do not require to be tested for reaction to fire (System 1) and are classified without testing (according to Commission Decision 96/603/EC).

Vitra DoPs are available on the catalogues and on the website:

<https://www.vitra.com.tr/performans-banyo-karo/>

Volatile organic compounds (VOCs) are emitted as gases under certain conditions (i.e. excessively high pressure etc.) from certain solids or liquids. The boiling range of VOCs is between 50-100 C and 240-260 C. Ceramic tiles are manufactured at temperatures higher than 1100 C and as a result of this high temperature process condition, the product no longer contains VOC substances. Since 1 September 2012 in France, all building products have to be labelled with an emissions classification on the basis of VOC emissions tests. As emission-neutral products, they are classified as A+. This label can be found on the boxes.

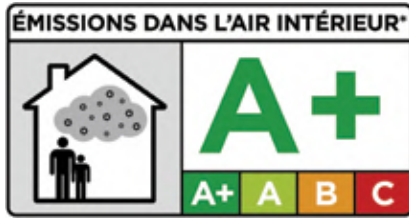

*Information sur le niveau d'émission de substances volatiles dans l'air intérieur, présentant un risque de toxicité par inhalation, sur une échelle de classe allant de A+ (très faibles émissions) à C (fortes émissions).



CE markalaması – performans beyanı ve VOC etiketi

CE markalaması bir ürünün beyan edilen performansına uygun olduğunu ve uyumlandırılan Avrupa standardına göre değerlendirildiğini göstermektedir. CE işareti AB için gerekli olan güvenli ürün sertifikalandırmasıdır ve insanların sağlığını ve binalardaki ürünleri korumak için oluşturulmuştur. Vitra ürünlerinin CE markalaması No 305/2011 no.lu Yönetmeliğin (AB) Ek V kısmına göre hazırlanmıştır. (568/2017 no.lu Delege edilen AB Yönetmeliğine göre değiştirilmiştir.)



Vitra ürünlerinin performanslarının beyanı 574/2014 no.lu delege edilen AB yönetmeliğinde sunulan modele göre hazırlanmıştır. Seramik karoların yangın reaksiyonu (1.Sistem) için test edilmesi gerekli değildir ve bunlar test edilmeden sınıflandırılmaktadır (96/603/EC Komite kararına göre).

Vitra DoP'ları kataloglarda ve aşağıdaki web sitesinde mevcuttur:

<https://www.vitra.com.tr/performans-banyo-karo/>

Uçucu organik bileşenler (VOC'ler) belirli koşullarda belli katı ve sıvılardan gaz olarak atılırlar (Örneğin fazla yüksek basınç altında vb.). VOC'lerin kaynama aralığı 50-100 °C ve 240-260 °C aralıklarındadır. Seramik karolar 1100 °C'nin üzerindeki sıcaklıklarda üretilirler ve bu yüksek ısı sürecinden dolayı, ürün artık VOC maddelerini içermez. 1 Eylül 2012 tarihinden itibaren Fransa'da tüm yapı ürünleri VOC emisyon testlerine göre emisyon sınıflandırması ile etiketlenmelidirler. Emisyon açısından nötr olan ürünler olarak karolar A+ olarak sınıflandırılmaktadırlar. Etiket kutuların üzerinde bulunmaktadır.

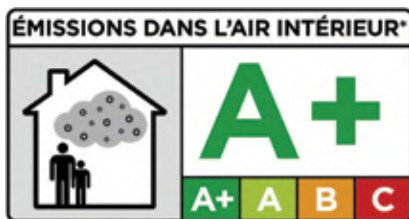

*Information sur le niveau d'émission de substances volatiles dans l'air intérieur, présentant un risque de toxicité par inhalation, sur une échelle de classe allant de A+ (très faibles émissions) à C (fortes émissions).



Terms and classification according to TS EN 14411

Tiles are usually shaped by extruding or dry-pressing at room temperature followed by drying and firing at temperatures sufficient to develop the required properties. They can also be formed by other processes, but these are not covered by this European Standard. Tiles can be glazed (GL) or unglazed (UGL). A tile with an engobed surface is regarded as an unglazed tile.

Table 1. Classification of the ceramic tiles according to their groups of Water absorption (E) and their shaping

Shaping	Group I $E \leq 0.5\%$	Group II _a $3\% < E \leq 6\%$	Group II _b $6\% < E \leq 10\%$	Group III $E > 10\%$
A Extruded tiles	Group AI _a $E \leq 0.5\%$ (see annex M)	Group AI _{a-1} (see annex B)	Group AI _{b-1} (see annex D)	Group AIII (see annex F)
	Group AI _b $0.5\% < E \leq 3\%$ (see annex A)	Group AI _{a-2} (see annex C)	Group AI _{b-2} (see annex E)	
B Dry pressed tiles	Group BI _a $E \leq 0.5\%$ (see annex G)	Group BI _a (see annex J)	Group BI _b (see annex K)	Group BIII (see annex L)
	Group BI _b $0.5\% < E \leq 3\%$ (see annex H)			

Traditionally the following terms are used:

Ceramic tiles

Tile made from clays and/or other inorganic raw materials.

Extruded tiles

Ceramic tile whose body is shaped in the plastic state in an extruder, the coulmn obtained being cut into tiles of pre-determined dimension.

Dry-pressed tiles

Tile formed from a finely milled body mixture and shaped by pressing.

Porcelain tiles

Fully vitrified ceramic tile with Water absorption of 0,5% or less.

Mosaics

Tiles that are small (Porcelain) stoneware tiles stuck onto sheets.

The water absorption E in weight-% is determined in accordance with EN ISO 10545-3.

TS EN 14411 standardına göre sınıflandırmalar ve terimler

Karolar genellikle oda sıcaklığında çekme veya kuru presleme ile şekillendirilir, ardından gerekli özellikleri sağlamak için yeterli sıcaklıklarda kurutulur ve fırınlanır. Başka üretim prosesleri ile de oluşturulabilirler, ancak bunlar Avrupa Standardı kapsamında değildir. Karolar, Sırlı (GL) veya sırsız (UGL) olabilir. Angop uygulanmış karolar, sırsız karo olarak kabul edilir.

Tablo 1. Su emme kapasitesi ve şekillendirme özelliklerine göre seramik karoların sınıflandırılması

Şekillendirme	Grup I $E \leq 0.5\%$	Grup II _a $3\% < E \leq 6\%$	Grup II _b $6\% < E \leq 10\%$	Grup III $E > 10\%$
A Çekme karolar	Grup AI _a $E \leq 0.5\%$ (ek M)	Grup AI _{a-1} (ek B)	Grup AI _{b-1} (ek D)	Grup AIII (ek F)
	Grup AI _b $0.5\% < E \leq 3\%$ (ek A)	Grup AI _{a-2} (ek C)	Grup AI _{b-2} (ek E)	
B Kuru preslenmiş karolar	Grup BI _a $E \leq 0.5\%$ (ek G)	Grup BI _a (ek J)	Grup BI _b (ek K)	Grup BIII (ek L)
	Grup BI _b $0.5\% < E \leq 3\%$ (ek H)			

Geleneksel olarak kullanılan terimler aşağıdaki gibidir:

Seramik karo

Kil ve/veya diğer inorganik ham maddelerden elde edilen karodur.

Çekme seramik karo

Karo hamurunun plastik halde bir ekstruderde şekillendirilmesi ile elde edilen, kütlenin önceden belirlenmiş boyutlarda kesilmesi ile üretilen seramik karolardır.

Kuru preslenmiş karo

Çok ince öğütülmüş ana karışımın preslenerek şekillendirilmesi ile elde edilen karodur.

Porselen seramik karo

Su emme kapasitesi % 0,5 veya daha az olacak şekilde tamamen sırlanmış (vitrifiye edilmiş) seramik karodur.

Mozaik

Küçük Porselen karoların fileye yapıştırılmasıyla oluşan karolardır.

Su emme kapasitesi E, seramik gövde tarafından emilen suyun yüzdesini (kütlece) belirtir, TS EN ISO 10545-3'e göre deney yapılır.

VitrA technical properties

Dimensions and surfaces

1. Dimensions, EN ISO 10545-2

All dimensions are determined in accordance with the standard.

EN 14411	Group Ala		Group Bla / Blb/ Blla	Group Blll
	Nature	Precision		
The permissible deviation of the average size for each tile from the work size (W)	± 2% to a maximum of ±4 mm	± 1.0% to a maximum of ±2 mm	± 0.6% and ±2,0 mm	± 0.5% and ± 2,0 mm

2. Surface quality, EN ISO 10545-2

At least 1 m² of tiles and a minimum of 30 of them shall be examined at 300 lux for visible defects at a distance of 1 m. For quality 1, a minimum of 95% of the tiles shall be free from visible defects that would impair the appearance of a major area of tiles.

3. Size grading (Calibre)

The production sizes vary for technical reasons. The production size is coded and stamped on the box. Only boxes with the same calibre should be laid together.

Physical properties

1. Water absorption, EN ISO 10545-3

A sample of each type of tile under test shall consist of 10 whole tiles. Using the below formula,

$$E = (m_2 - m_1) / m_1 \times 100$$

m₂ is the mass of the wet tile;

m₁ is the mass of the dry tile

The Water absorption (E) gives the weight increase in % as compared to the dry weight of boiled samples saturated with water.

1.1. Apparent density, EN ISO 10545-3

It gives the ratio between mass and external volume.

2. Modulus of rupture, EN ISO 10545-4

Breaking strength, breaking load and modulus of rupture of a tile are determined by applying a force at a definite rate to the centre of a tile. Specimens are selected arbitrarily from the part.

Minimum number of test specimens are;

Dimension of the tile in mm	Minimum number of test specimens
18 < L ≤ 48	10
48 < L ≤ 1000	7
L > 1000	5

Breaking strength is calculated by using the below formula,

Breaking strength; $S = FL/b$

Modulus of rupture; $R = 3FL/(2bh^2)$

where

• F is the breaking load; in Newtons

• L is the bearing span, in millimeters

• B is the width of the test specimen, in millimeters

• h is the minimum thickness of the test specimen, in millimeters

Boyut ve yüzey kalitesi

1. Boyut, TS EN ISO 10545-2

Tüm boyutlar standartlara uygun olarak belirlenir.

EN 14411	Group Ala		Grup Bla / Blb/ Blla	Grup Blll
	Doğal	Hassas		
Her bir karonun ortalama boyutunun çalışma boyutundan (W) sapması	± 2% en çok ±4 mm	± 1.0% en çok ±2 mm	± 0.6% ve ±2,0 mm	± 0.5% ve ± 2,0 mm

2. Yüzey kalitesi, TS EN ISO 10545-2

En az 1 m² ve en az 30 adet karo, üst yüzeyleri 1 m mesafeden dik olarak görülecek şekilde 300 lx ışık altında incelenir. Kalite 1 için, karoların en az %95'i, asıl görünümü bozan yüzey hatalarından arındırılmış olmaktadır.

3. Boyutlandırma (Kalibre)

Üretim boyutları teknik nedenlerden dolayı değişmektedir. Üretim boyutu kutu üzerine yazılır ve işaretlenir. Sadece aynı kalibreye sahip kutular/karolar birlikte döşenmelidir.

Fiziksel özellikler

1. Su emme, TS EN ISO 10545-3

Test edilen her tipteki karo, 10 adet bütün karodan oluşmaktadır. Su emme aşağıdaki formül kullanılarak hesaplanır:

$$E = (m_2 - m_1) / m_1 \times 100$$

m² ıslak karo kütlesi;

m¹ kuru karo kütlesi

Su emme değeri (E), su ile doyurulmuş numunelerin kuru ağırlığına kıyasla ağırlık artışını % olarak verir.

1.1. Görünen gözeneklilik, TS EN ISO 10545-3

Görünen gözeneklilik, deney numunesinin açık gözeneklerin hacminin dış hacmine oranının yüzdesi olarak ifade edilir.

2. Kopma modülü ve kırılma dayanımı, TS EN ISO 10545-4

Bir karonun Kırılma dayanımı, kırılma yükü ve kopma modülü karonun merkezine belirli bir oranda kuvvet uygulayarak belirlenir.

Örnekleme üretim partisinden rassal olarak yapılır.

Gereken test numunesi adetleri;

Karo boyutu mm cinsinden	Gereken test numune adedi (en az)
18 < L ≤ 48	10
48 < L ≤ 1000	7
L > 1000	5

Kırılma dayanımı aşağıdaki formül ile hesaplanır,

Kırılma dayanımı: $S = FL/b$

Kırılma katsayısı: $R = 3FL / (2bh^2)$

formülünde;

• F Kırılma yükü; (Newton)

• L Mesnet çubukları arasındaki açıklık (mm)

• B Deney numunesinin genişliği (mm)

• h Deney numunesinin deneyden sonra kırılmış kenar boyunca ölçülen en küçük kalınlığı (mm)

VitrA technical properties

3. Resistance to shock, EN ISO 10545-5

A minimum of 5 pieces in dimensions 75 mm x 75 mm cut from five tiles used in the test for determination of the coefficient of restitution by dropping a steel ball from a fixed height onto the test specimen and measuring the height of rebound.

4. Resistance to deep abrasion, EN ISO 10545-6

Tests shall be carried out using whole tiles or test specimens of suitable dimensions. Before testing, small specimens shall be fixed with an adhesive on to a larger background, avoiding joints. Purpose is to determine the abrasion resistance of unglazed tiles by measuring the length of the groove produced in the proper surface by means of a rotating steel disc, under given conditions and with the use of abrasive material.

5. Glaze abrasion, EN ISO 10545-7

The abrasion class of glazed tiles is established in the wet test. Artificial abrasion is produced with the help of aluminium oxide grains, steel balls and the addition of water in an eccentrically revolving system. The number of revolutions at which a visible change of the test surface occurs results in the following classification:

Abrasion stage, Failure visible at revolutions	Class
100	0
150	1
600	2
750, 1500	3
2100, 6000, 12000	4
> 12000*	5

* Must pass the stain test according to EN ISO 10545-14

Abrasion class	Usage areas
Class 0	The use of glazed tiles of this class is unsuitable for floor.
Class 1	For using the tiles in areas walked on in soft footwear or barefoot and no abrasive dirt contamination. For example; bathrooms and bedrooms in the houses.
Class 2	This class is suitable for usage of tiles in areas infrequently walked on with soft or normal shoes and exposed to only small amount of abrasive dirt contamination. For example; rooms in living areas of houses, except kitchens, entrances, terraces, stairs and heavily frequented used rooms.
Class 3	For floors in areas subject to frequently walking on with normal shoes and abrasive dirt contamination. For example; all rooms in the house including bathrooms, kitchens, entrances, stairs etc.
Class 4	For floors in areas subject to frequently walking and frequent, intense soiling. For example; commercial kitchens, terraces, offices, hotels, schools, hospitals etc.
Class 5	This class is the highest for the wear resistance is suitable for using the tiles in areas that subject to heavy pedestrian traffic and abrasive dirt contamination. For example; shopping centres, airports, banks, restaurants etc.

6. Linear thermal expansion, EN ISO 10545-8

The test is used to determine linear thermal expansion coefficient for the temperature range from ambient temperature to 100°C and prepared by cutting two test specimens at right angles from the central portion of one tile so that their lengths are suitable for the apparatus. Then ends of the test specimens shall be ground flat and parallel.

The linear thermal expansion coefficient, α , is expressed in 10^{-6} per degree Celsius ($10^{-6}/^{\circ}\text{C}$), to the first decimal place, in accordance with the expression

$$\alpha = \frac{1}{L_0} \times \frac{\Delta L}{\Delta t}$$

where

- L_0 is the length of the test specimen at the ambient temperature;
- ΔL is the increase in length of the test specimen between ambient temperature and 100 °C;
- Δt is the rise in temperature

VitrA teknik özellikler

3. Çarpma dayanımı, TS EN ISO 10545-5

Testte kullanılan beş karodan 75 mm x 75 mm boyutunda en az 5 parça, sabit bir yükseklikten test numunesi üzerine çelik bilyenin düşürülmesi ve sıçrama yüksekliğinin ölçülmesi ile geri gelme katsayısının belirlenmesi için kullanılmaktadır.

4. Derin aşınma dayanımı, TS EN ISO 10545-6

Derin aşınma testi, bütün haldeki karolar veya uygun boyutlardaki test numuneleri kullanılarak gerçekleştirilmektedir. Testten önce, küçük boyuttaki numuneler, derzlerden kaçınarak daha büyük bir arka plan üzerine yapıştırıcı ile sabitlenmektedir. Amaç, belirli koşullar altında ve aşındırıcı malzemenin kullanımıyla, dönen bir çelik disk vasıtasıyla yüzeyde oluşan çukur alanın uzunluğunu ölçerek, sırsız karoların aşınma direncini belirlemektir.

5. Yüzey aşınma, TS EN ISO 10545-7

Islak test ile Sırlı karoların aşınma sınıfları belirlenir. Yapay aşınma; alüminyum oksit tanecikleri, çelik bilyeler ve eksantrik olarak dönen bir sistemde suyun eklenmesiyle sağlanır. Test yüzeyinde gözle görülür bir değişimin meydana geldiği devir sayısı, aşağıdaki sınıflandırma ile sonuçlanır:

Aşınma kademesi, Kusurun görüldüğü devirler	Sınıf
100	0
150	1
600	2
750, 1500	3
2100, 6000, 12000	4
> 12000*	5

* EN ISO 10545-14'te belirtilen lekelenmeye dayanıklılık deneyini başarıyla geçmelidir.

Aşınma sınıfı	Kullanım alanları
Sınıf 0	Bu sınıflandırmaya sahip ürünler Yer karosu olarak kullanıma uygun değildir.
Sınıf 1	Yumuşak tabanlı ayakkabı veya çıplak ayakla yürünen bölgelerde aşındırıcı kire maruz kalmayan alanlarda kullanıma uygundur. Örneğin; evlerde banyo ve yatak odası.
Sınıf 2	Bu sınıf, yumuşak veya normal tabanlı ayakkabılarla sık olarak yürünmeyen ve yalnızca az miktarda aşındırıcı kirlenmeye maruz kalan alanlarda kullanım için uygundur. Örneğin; mutfak, giriş, teras, merdiven ve yoğun olarak kullanılan odalar hariç olmak üzere, evlerdeki yaşam alanları.
Sınıf 3	Normal ayakkabılarla ve aşındırıcı kirlenmeye maruz kalan yerlerdeki zeminlerde kullanıma uygundur. Örneğin; Evdeki tüm odalar banyo, mutfak, giriş, merdiven vb.
Sınıf 4	Sık yürünen ve sık yoğun kirlenmeye maruz kalan bölgelerdeki zeminler için uygundur. Örneğin; ticari mutfaklar, teraslar, ofisler, oteller, okullar, hastaneler vb.
Sınıf 5	Aşınma direnci en yüksek olan bu sınıf, yaya trafiğine ve aşındırıcı yoğun kirliliğe maruz kalan alanlarda kullanmak için uygundur. Örneğin; alışveriş merkezleri, havaalanları, bankalar, restoranlar vb.

6. Doğrusal ısı genleşme, TS EN ISO 10545-8

Bu testin amacı, ortam sıcaklığı ile 100 °C arasındaki sıcaklık aralığı için doğrusal ısı genleşme katsayısını belirlemektir. Test için bir karonun orta kısmından, cihaza uygun boylarda, birbirine dik açı yapacak şekilde, iki adet deney numunesi kesilmektedir. Deney numunelerinin uçları, düzgün ve birbirine paralel olarak taşlanmaktadır.

Lineer ısı genleşme katsayısı, α_L , 10⁻⁶/°C birimiyle ifade edilir. Aşağıdaki formül yardımıyla hesaplanır:

$$\alpha_L = \frac{1}{L_0} \times \frac{\Delta L}{\Delta t}$$

formülünde;

- L_0 Deney numunesinin ortam sıcaklığındaki uzunluğu,
- ΔL Ortam sıcaklığı ile 100 °C arasında deney numunesinin uzunluk artışı,
- Δt Sıcaklık artışı

VitrA technical properties

7. Thermal shock resistance, EN ISO 10545-9

Purpose of the test is to determine the resistance of thermal shock of a whole tile by cycling 10 times between the temperatures of 15 °C and 145 °C.

A minimum of five whole tiles shall be tested.

8. Moisture expansion, EN 10545-10

The test is performed to determine moisture expansion which is proportional accelerated expansion that results from subjecting reheated tiles to extended immersion in boiling water.

A sample consists of five whole tiles.

9. Crazing resistance, EN 10545-11

Crazing refers to the fine hairline cracks to be found in the glaze of nonvitreous tiles and glass plating.

A minimum of five whole tiles shall be tested and exceptionally large tiles may be cut into pieces for enclosure in the autoclave, but all pieces shall be tested. The cut pieces shall be as large as possible.

10. Frost resistance, EN ISO 10545-12

Main criterion for using tiles outdoors. Required, according to EN 14411 Group BIa for Porcelain stoneware and EN 14411 group BIb for vitreous tiles. Frost damage can occur, however, even with tiles complying with standards, if they are laid incorrectly or on defective substrate.

11. Colour deviations, EN ISO 10545-16

For quantifying the small colour differences between plain coloured ceramic tiles, which are designed to be of uniform and consistent colour.

Specimens which are compared to a reference standard will fall into two categories: those are which the ΔE_{cmc} values are less than or equal to the agreed upon tolerance are acceptable (pass), while those for which the ΔE_{cmc} values are greater than the agreed upon tolerance are unacceptable (fail).

12. Behaviour in fire

Ceramic tiles are classified A1 according to EN ISO 13501-1 and EN 14411. Therefore, they are generally non-combustible and thus fire-resistant. Also in the case of fire they do not release any toxic emissions.

VitrA teknik özellikler

7. Isı şokuna dayanıklılık, TS EN ISO 10545-9

Testin amacı, bütün bir karonun 15 °C ve 145 °C sıcaklıklar arasında 10 defa çevirim yapılarak ısı şokuna dayanıklılığını belirlemektir. En az 5 bütün karo test edilir.

8. Rutubet genişmesi, EN 10545-10

Amaç, karolarda rutubet genişmesini belirlemektir. Rutubet genişmesi, yeniden ısıtılıp soğutulan karonun kaynar su içerisine daldırılarak geniştirilmesi sonucunda oluşan hızlandırılmış bağıl genişmedir. Beş bütün karo test edilir.

9. Sırın çatlama dayanımı, EN 10545-11

Sır çatlağı, karonun sadece Sırlı yüzeyinde oluşmuş, saç teli inceliğinde, kılcak çatlaktır. En az beş adet bütün karo denir. İstisna olarak, büyük karolar otoklava sığması için kesilebilir, fakat bu durumda kesilen bütün parçalar deneye alınır. Kesilen parçalar mümkün olduğu kadar büyük olmalıdır.

10. Dona dayanıklılık, TS EN ISO 10545-12

Dona dayanıklılık, Dış mekânlarda kullanılacak karolar için şarttır. EN 14411'e göre Grup Bla porselen ve Grup Blb seramik karolar Dona dayanım şartını sağlamış olmalıdır. Ancak, hatalı olarak veya uygunsuz bir zemin üzerine döşenen karolarda, standartlara uygun olsa bile dondan hasar oluşabilir.

11. Küçük renk farklılıkları, TS EN ISO 10545-16

Bir örnek ve birbirine uygun renk vermesi için tasarlanmış, tek renkli Sırlı/sırsız seramik karolar arasındaki küçük renk farklılıklarını tayin etmek için kullanılır. Numuneler referans numune ile karşılaştırıldığında iki ana gruba ayrılır. ΔEcmc değerleri önceden kabul edilebilen en uygun toleranstan küçük veya ona eşit olanlar kabul edilir. ΔEcmc değerleri önceden kabul edilebilen uygun toleranstan büyük olanlar kabul edilmez.

12. Yangına tepki

Seramik karolar TS EN ISO 13501-1 ve EN 14411'e göre A1 olarak sınıflandırılmıştır. Bu sebeple, genellikle yanmaz ve dolayısıyla ateşe dayanıklıdır. Ayrıca yangın durumunda, herhangi bir toksik madde yaymazlar.

Chemical properties

1. Chemical resistance, EN ISO 10545-13

Subjection of the test specimens to the action of the test solutions and visual determination of attack after a defined period.

Medium	Concentration
1 Aqueous test solutions	
1.1 Household chemicals / swimming pool additives	
Ammonium-chloride solution	100 g/l
Sodium hypochlorite solution	20 mg/l
Classification groups	A/B/C
1.2 Acids and alkalis	
1.2.1 Low concentrations (L)	
Hydrochloric acid	3%
Citric acid	100 g/l
Potassium hydroxide	30 g/l
Classification groups	LA/LB/LC
1.2.2 High concentrations (H)	
Hydrochloric acid	18%
Lactic acid	5%
Potassium hydroxide	100 g/l
Classification groups	HA/HB/HC

* Class A shows the highest resistance to chemicals, which decreases more and more towards C.

Number of specimens can be listed as;

Tile maximum area, A (cm ²)	Total Number of Tests Specimens (Tiles)
200 < A ≤ 3600	3
A > 3600	3
When A is ≤ 200 cm ² , the total number of test specimens (tiles) should be sufficient to cover an area of 200 cm ²	

2. Stain resistance, EN ISO 10545-14

Determination of the resistance to stains by maintaining test solutions and materials in contact with the proper surface of the tiles for a suitable length of time; the surfaces are then subjected to defined cleaning methods, and finally inspected for visual changes.

Chemicals used in the test can be listed as;

- Stains leaving a trace

Green staining agent in light oil

Red staining agent in light oil

- Stains having chemical/oxidizing action

Iodine, 13g/l in alcohol

- Stain forming a film

Olive oil

Cleaning (within the framework of the test)

- Cleaning agent

Hot water (+55 °C)

Weak cleaning agent

Strong cleaning agent

- Solvent

Hydrochloric acid solution 3% (V/V)

Potassium hydroxide 200g/l

Acetone

Classes

Cl. 5 / Cl. 4 / Cl. 3 / Cl. 2 / Cl. 1

Class 5 shows the highest stain resistance, which decreases more and more towards 1.

Kimyasal özellikler

1. Kimyasal maddelere dayanıklılık, TS EN ISO 10545-13

Testin amacı, deney numunelerini deney çözeltilerinin etkisine maruz bırakmak ve belirli bir süre sonunda oluşabilecek hasarı gözle incelemektir.

Ortam	Konsantrasyon
1 Sulu deney çözeltileri	
1.1 Ev kimyasalları / yüzde havuzu tuzları	
Amonyum klorür çözeltisi	100 g/l
Sodyum hipoklorit çözeltisi	20 mg/l
Sınıflandırma grupları	A/B/C
1.2 Asit ve alkaliler	
1.2.1 Düşük konsantrasyonlar (L)	
Hidroklorik asit çözeltisi	3%
Sitrik asit çözeltisi	100 g/l
Potasyum hidroksit çözeltisi	30 g/l
Sınıflandırma grupları	LA/LB/LC
1.2.2 Yüksek konsantrasyonlar (H)	
Hidroklorik asit çözeltisi	18%
Laktik asit çözeltisi	5%
Potasyum hidroksit çözeltisi	100 g/l
Sınıflandırma grupları	HA/HB/HC

* A sınıfı, kimyasallara karşı en yüksek dayanımı gösterir, bu da C'ye doğru gittikçe azalır.

Test numunelerinin sayısı aşağıdaki gibidir:

Karo alanı, A (cm ²)	Toplam deney numune sayısı (karo)
200 < A ≤ 3600	3
A > 3600	3

Alan 200 cm²'e eşit veya küçükse, 200 cm²'yi kaplayacak kadar deney numunesi yeterlidir.

2. Lekelenmeye dayanıklılık, TS EN ISO 10545-14

Karoların üst yüzeyinin deney çözeltileri ve maddeleri ile uygun bir süre boyunca temas halinde bulundurulması, daha sonra yüzeylerin belirli temizleme metotlarına tâbi tutulması ve son olarak görüntü değişikliklerinin kontrol edilmesi ile lekelenmeye dayanıklılıklarının tayinidir.

Kullanılan kimyasallar aşağıdaki gibidir:

- Kalıntı bırakan lekelenendiriciler

İnce Yağ İçinde Yeşil Lekelenendirici Madde

İnce Yağ İçinde Kırmızı Lekelenendirici Madde

- Kimyasal ve oksitleyici etkili lekelenendiriciler

İyot, alkoldeki 13 g/l'lik çözeltisi

- Film oluşturan lekelenendiriciler

Zeytinyağı

Temizleme

- Temizleyici maddeler

Sıcak su (55 ± 5 °C sıcaklıkta)

Zayıf temizleme maddesi

Güçlü temizleme maddesi

- Uygun çözücüler

Hidroklorik asit çözeltisi, hacimce 3% (V/V)

Potasyum hidroksit çözeltisi, 200 g/l'lik

Aseton

Sınıflandırma

Sınıf 5 / Sınıf 4 / Sınıf 3 / Sınıf 2 / Sınıf 1

Sınıf 5 en yüksek lekelenmeye karşı direnci gösterir, bu da 1'e doğru gittikçe azalır.

1. Coefficient of friction / Slip resistance

Slip-resistant coverings in publicly accessible areas are distinguished according to those that are walked over barefoot or in footwear. Special protective measures against slipping are necessary where there is a risk due to use of water, oil, slush, grease or waste. This should be taken into consideration when choosing the surface material.

The slip resistance value of installed tiles can change over time as a result of wear and surface contaminants. In addition to regular cleaning, deep cleaning and traction-enhancing maintenance may be needed periodically to maintain the slip resistance values. (Ref: ANSI A137.1-2017)

There are many factors that affect the possibility of a slip occurring on a surface including by way of example, but not in limitation, the following: the material of the shoe sole and the degree of its wear; the presence and nature of surface contaminants; the speed and length of stride at the time of a slip; the physical and mental condition of the individual at the time of a slip; whether the floor is flat or inclined; how the hard surface flooring material is used and maintained, and the slip resistance classification of the material, how the flooring surface is structured, and how drainage takes place if liquids are involved. Because many variables affect the risk of a slip occurring, the slip resistance classification shall not be the only factor in determining the appropriateness of a hard surface flooring material for a particular application. (Ref: ANSI A326.3 April 2017)

1.1. Slip resistance properties in commercial applications

DIN 51130 is the test method that is used for determining slip resistance of floor coverings in work rooms and work areas subject to higher risk of slipping. Working rooms and areas are classified according to five assessment groups on the basis of size and the risk of slipping. The lowest slip resistance value is R9 whereas the highest one is R13 for industrial slip resistance of tiles.

In table of industrial areas slip resistance classification and collection space, the application areas are indicated in accordance with "ASR 1.5/1.2 Technical Regulations for workplaces -Floors".



$6^\circ < R9 < 10^\circ$ Low static friction



$10^\circ < R10 < 19^\circ$ Normal static friction



$19^\circ < R11 < 27^\circ$ Increased static friction



$27^\circ < R12 < 35^\circ$ High static friction



$R13 > 35^\circ$ Very high static friction

Open field test

Important Notice: The indicated angles of inclination helps to identify anti-slip classification of the product and cannot be related to the angles of inclination of slopes/ramps.

VitrA kayma dayanımı

1. Sürtünme katsayısı / Kayma direnci

Kamuya açık alanlardaki kaymaya karşı dayanıklı karolar çıplak ayakla veya ayakkabıyla üzerinde yürünenler olarak ayırt edilmektedir. Su, yağ, çamur, makine yağı veya atık kullanımı nedeniyle risk olan yerlerde kaymaya karşı özel koruyucu tedbirler gereklidir. Bu durum yüzey materyali seçilirken dikkate alınmalıdır.

Döşenen karoların kaymaya karşı dayanıklılık değeri aşınma ve yüzey kirleri nedeniyle zaman içinde değişebilmektedir. Kaymaya karşı dayanıklılık değerlerinin korunması için düzenli temizlemenin yanında, derinlemesine temizlik ve çekiş artırıcı bakım periyodik olarak gerekebilecektir. (Ref: ANSI A137.1-2017)

Bir yüzeydeki kayma olasılığını etkileyebilecek olan pek çok faktör mevcuttur. Örnek olarak verilebilecekler: Ayakkabı tabanının malzemesi ve aşınma derecesi; yüzey kirlerinin mevcut olması ve yapısı; kayma sırasındaki geçişin hızı ve uzunluğu; bir kayma sırasında bireyin fiziksel ve zihinsel durumu; zeminin düz mü yoksa eğimli mi olduğu; sert zemin döşeme malzemesinin nasıl kullanıldığı ve muhafaza edildiği ve malzemenin kayma dayanıklılık sınıflandırması, zemin yüzeyinin nasıl yapılandırıldığı ve sıvılar söz konusu olduğunda tahliyenin nasıl gerçekleştiği gibi faktörlerdir. Kayma riskinin oluşmasını etkileyebilecek pek çok değişken olduğundan, belirli bir uygulama için karonun kullanım uygunluğunun belirlenmesinde kayma dayanım sınıflandırması tek unsur olmayacaktır. (Ref: ANSI A326.3 Nisan 2017)

1.1. Endüstriyel alanlarda kayma direnci

DIN 51130, yüksek kayma riski olan çalışma odaları ve çalışma alanlarındaki zemin kaplamalarının kayma direncini belirlemek için kullanılan test yöntemidir. Çalışma alanları kayma riskine göre beş değerlendirme grubu içerisinde sınıflandırılmıştır. Karoların endüstriyel kayma direnci için en düşük kaymazlık değeri R9 iken, en yüksek olanı R13'tür.

Endüstriyel alanların kayma direnci sınıflandırması ve dolma hacmi tablosunda, uygulama alanları "ASR 1.5/1.2 İşyerleri için Teknik Düzenlemeler'e göre belirlenmiştir.



$$6^\circ < R9 < 10^\circ$$

Düşük statik sürtünme



$$10^\circ < R10 < 19^\circ$$

Normal statik sürtünme



$$19^\circ < R11 < 27^\circ$$

Yükseltilmiş statik sürtünme



$$27^\circ < R12 < 35^\circ$$

Yüksek statik sürtünme



$$R13 > 35^\circ$$

Çok yüksek statik sürtünme

Açık alan testi

Önemli Not: Belirtilen eğim açıları ürünün kaymazlık sınıflandırmasının belirlenmesine yardımcı olmaktadır ve eğim ve rampaların eğim açılarıyla ilişkilendirilemezler.

VitrA slip resistance

1.1.1. Working rooms and areas with risk of slipping (in accordance with ASR A1.5/1,2)

DIN 51130 is the test method that is used for determining slip resistance of floor coverings in work rooms and work areas subject to higher risk of slipping. Working rooms and areas are classified according to five assessment groups on the basis of size and the risk of slipping. The lowest slip resistance value is R9 whereas the highest one is R13 for industrial slip resistance of tiles.

In table of industrial areas slip resistance classification and collection space, the application areas are indicated in accordance with "ASR 1.5/1,2 Technical Regulations for workplaces –Floors".

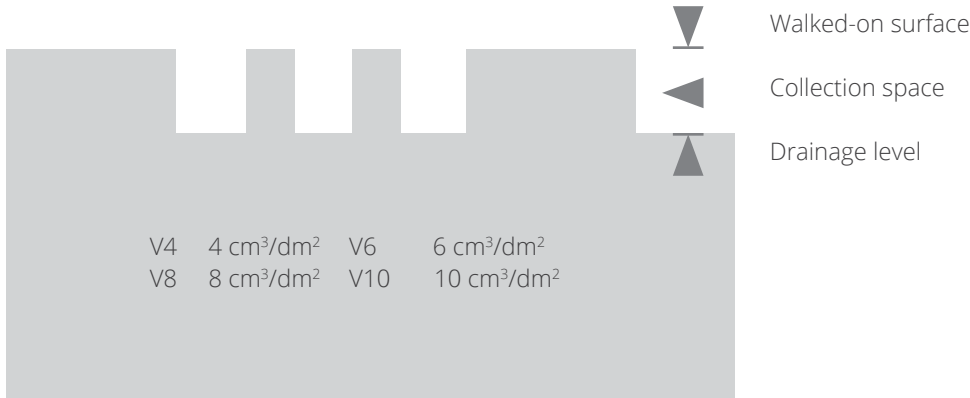

The displacement space (V4-V10) is the open space between the upper walked-on surface and the drainage level of profiled surfaces.

Industrial areas slip resistance classification and collection space - Application areas

Nr.	Working areas, walking corridors	Antislip groups (R classes)	Minimum collection space	Nr.	Working areas, walking corridors	Antislip groups (R classes)	Minimum collection space
0	General working rooms and areas			9.5	Food preparation kitchens (fast-food kitchens, snack bars)	R 12	V 4
0.1	Entrance areas (inside)	R 9		9.6	Kitchens for heating up frozen meals	R10	
0.2	Entrance areas (outside)	R 11 - R 10	V 4	9.7	Coffee and tea kitchens, hotel garni kitchens and ward kitchens	R10	
0.3	Stairs (inside)	R 9		9.8	Washing-up areas		
0.4	Stairs (outside)	R 11 - R 10	V 4	9.8.1	Washing-up areas for 9.1, 9.4, 9.5	R 12	V 4
0.5	Sloping ramps, inside* (e.g. for wheelchairs, leveling slopes, transport paths)	R10		9.8.2	Washing-up areas for 9.2	R 11	
0.6	Sanitary rooms	R 9		9.8.3	Washing-up areas for 9.3	R 12	
0.6.1	Toilets			9.9	Dining rooms, guest rooms, canteens including serving counters	R 9	
0.6.2	Changing or washrooms			10	Cold stores, deep freeze stores		
0.7	Break rooms (e.g. dayrooms, canteens)			10.1	For unpacked goods	R 12	
0.8	First aid rooms and similar facilities (see ASR A4.3)			10.2	For packed goods	R 11	
1	Manufacture of margarine, edible fats and oils			11	Sales outlets, shops		
1.1	Melting of fat	R 13	V 6	11.1	Reception of goods, meats		
1.2	Cooking oil refinery	R 13	V 4	11.1.1	For unpacked goods	R 11	
1.3	Margarine production and packaging	R 12		11.1.2	For packed goods	R 10	
1.4	Cooking fat production and packing, oil bottling	R 12		11.2	Reception of goods, fish	R 11	
2	Milk processing, cheese production			11.3	Serving counters for meat and sausage		
2.1	Fresh milk processing and butter production	R 12		11.3.1	For unpacked goods	R 11	
2.2	Cheese production, storage and packaging	R 11		11.3.2	For packed goods	R 10	
2.3	Icecream manufacturing	R 12		11.4	Serving counters for bread, cakes and pastries, unpacked goods	R 10	
3	Chocolate and confectionery production			11.5	Serving counters for cheese and cheese products, unpacked goods	R 10	
3.1	Sugar processing	R 12		11.6	Serving counters for fish		
3.2	Cocoa production	R 12		11.6.1	For unpacked goods	R 12	
3.3	Production of raw mixtures	R 11		11.6.2	For packed goods	R 11	
3.4	Fabrication of chocolate bars, shells and filled chocolates	R 11		11.7	Serving counters from Nr.11.3 to 11.6	R 9	
4	Production of bread, cakes and pastries (bakeries, cake shops, production of long-life bakery products)			11.8	Meat preparation rooms		
4.1	Dough production	R 11		11.8.1	For meat preparation, except for no.5	R 12	V 8
4.2	Rooms in which predominantly fats or liquid mixtures are processed	R 12		11.8.2	For meat processing, except for no.5	R 11	
4.3	Washing-up rooms	R 12	V 4	11.9	Florists shops	R 11	
5	Slaughtering, meat processing			11.10	Sales areas with stationary ovens		
5.1	Slaughter house	R 13	V 10	11.10.1	For the production of bread, cakes and pastries	R 11	
5.2	Tripe processing room	R 13	V 10	11.10.2	For the warming-up of refabricated bread, cakes and pastries	R 10	
5.3	Meat sectioning	R 13	V 8	11.11	Sales areas with stationary chip pans or grills	R 12	V 4
5.4	Sausage kitchen	R 13	V 8	11.12	Shops, customer rooms	R 9	
5.5	Boiled sausage unit	R 13	V 8	11.13	Preparation areas for food and self-service shops	R 10	
5.6	Raw sausage unit	R 13	V 6	11.14	Cash register areas, packing areas	R 9	
5.7	Sausage drying room	R 12		11.15	Outdoor sales areas	R 11 - R10	V 4
5.8	Smoking establishments	R 12		12	Health service rooms		
5.9	Salting and curing rooms	R 12		12.1	Disinfection rooms (wet)	R 11	
5.10	Poultry processing	R 12	V 6	12.2	Pre-cleaning areas of sterilization	R10	
5.11	Gut store	R 12		12.3	Faeces disposal rooms, discharge rooms, unclean nursing work rooms	R 10	
5.12	Cold cuts and packaging unit	R 12	V 8	12.4	Pathological facilities	R 10	
6	Fish processing, production of delicatessen			12.5	Rooms for medical baths, hydrotherapy, fango preparation	R 11	
6.1	Fish processing	R 13	V 10	12.6	Washrooms of operating theatres, plastering rooms	R 10	
6.2	Production of delicatessen	R 13	V 6	12.7	Sanitary rooms, ward bathrooms	R 10	
6.3	Manufacture of mayonnaise	R 13	V 4	12.8	Rooms for medical diagnosis and therapy, massage rooms	R 9	
7	Processing of vegetables			12.9	Operation theatres	R 9	
7.1	Production of sauerkraut	R 13	V 6	12.10	Wards with hospital rooms and corridors	R 9	
7.2	Vegetable tinning	R 13	V 6	12.11	Medical practices, day clinics	R 9	
7.3	Sterilization rooms	R 11		12.12	Pharmacies	R 9	
7.4	Rooms in which vegetables are prepared for processing	R 12	V 4	12.13	Laboratories	R 9	
8	Food areas in food and beverage production (if not specifically mentioned)			12.14	Hairdressing salons		
8.1	Storage cellars	R 10		13	Laundries		
8.2	Beverage bottling, fruit juice production	R 11		13.1	Rooms with continuous-flow washing machines	R 9	
9	Catering establishments			13.2	Rooms with washing machines or with spin-drier	R 11	
9.1	Kitchens in the catering trade (restaurant kitchens, hotel kitchens)			13.3	Ironing rooms	R 9	
9.1.1	Up to 100 meals per day	R 11	V 4	14	Fodder concentrate production		
9.1.2	More than 100 meals per day	R 12	V 4	14.1	Dried fodder production	R 11	
9.2	Catering kitchens serving to homes, schools, kindergartens, sanatoria	R 11		14.2	Fodder concentrate production using fat and water	R 11	V 4
9.3	Kitchens of hospitals and clinics	R 12					
9.4	Catering kitchens serving to universities and industrial canteens	R 12	V 4				

Industrial areas slip resistance classification and collection space - Application areas

Nr.	Working areas, walking corridors	Antislip groups (R classes)	Minimum collection space	Nr.	Working areas, walking corridors	Antislip groups (R classes)	Minimum collection space
15	Leather productions, textiles			24.3	Washing halls	R 12	
15.1	Wet areas in tanneries	R 13		25	Sewage treatment plants	R 11	V 4
15.2	Rooms with fleshing machines	R 13		25.1	Pump rooms		
15.3	Areas where leather scraps accumulate	R 13	V 10	25.2	Rooms for sludge draining facilities	R 12	
15.4	Rooms for making leather impermeable by means of grease	R 12	V 10	25.3	Rooms for screening equipment	R 12	
15.5	Dye mills for textures	R 11		25.4	Stands of workplaces, scaffolds and maintenance platforms	R 12	
16	Paint shops			26	Fire brigade buildings	R 12	
16.1	Wet grinding areas	R 12		26.1	Vehicle parking places		
17	Ceramic industry			26.2	Rooms for hose maintenance equipment	R 12	
17.1	Wet grinding mills (processing of ceramic, raw materials)	R 11	V 10	27	Functional rooms in the breathing apparatus training facility	R 12	
17.2	Mixers; handling of materials like tar, pitch, graphite and synthetic resins	R 11		27.1	Preparation room		
17.3	Presses (shaping); handling of materials like tar, pitch, graphite and synthetic resins	R 11	V 6	27.2	Conditioning room		
17.4	Casting / die casting areas	R 12	V 6	27.3	Training room		
17.5	Glazing areas	R 12		27.4	Air lock		
18	Glass and stone processing			27.5	Mock-up dwelling		
18.1	Stone cutting, stone grinding	R 11		27.6	Heat acclimatization room		
18.2	Glass moulding of hollow glass, container glass, structural glass	R 11		27.7	Control station		
18.3	Grinding areas for hollow glass ware, flat glass	R 11		28	Schools and day nurseries	R 9	
18.4	Insulating glass manufacture; handling of drying agents	R 11		28.1	Class rooms, group rooms		
18.5	Packaging, shipping of flat glass; handling of anti-adhesive agents	R 11	V 6	28.2	Stairs	R 10	
18.6	Etching and acid polishing facilities for glass	R 11	V 6	28.3	Toilets, washrooms	R 11 - R 10	V 4
19	Cast concrete factories			28.4	Instructional kitchens in schools (also see no.9)	R 11 - R 10	V 4
19.1	Concrete washing areas	R 11		28.5	Kitchens in kindergartens (also see no.9)		
20	Storage rooms			28.6	Machine rooms for wood processing	R 9	
20.1	Storage areas for oils and fats	R 12		28.7	Special rooms for handicrafts	R 9	
20.2	Storage areas for packed food	R 10	V 6	28.8	Schoolyards	R 9	
20.3	Outdoor storage areas	R 11 - R 10		29	Banks	R 10	
21	Chemical and thermal treatment of iron and metal			29.1	Bank counter	R 10	
21.1	Pickling plants	R 12	V 4	30	Plant traffic routes in outdoor areas	R 10	
21.2	Hardening shops	R 12		30.1	Footpaths	R 10	
21.3	Laboratory rooms	R 11		30.2	Loading platforms	R 10	
22	Metal processing, metal workshops			30.2.1	Covered	R 11 - R 10	V 4
22.1	Galvanizing shops	R 12		30.2.2	Not covered		
22.2	Grey cast iron processing	R 11		30.3	Sloping ramps (e.g. for wheel-chairs, loading platforms)	R 11 - R 10	V 4
22.3	Mechanical processing areas (turnery, milling shop), punching room, pressroom, drawing shop (pipes, wires) and areas exposed to increased stress by oil and lubricants	R 11	V 4	30.4.1	Covered		
			V 4	30.4.2	Not covered	R 11 - R 10	V 4
22.4	Parts cleaning areas, exhaust steam areas			31	Parking areas	R 12	V 4
23	Vehicle repair workshops			31.1	Garages, multi-storey and underground car parks not subject to the effects of the weather	R 12	
23.1	Repair and servicing bays	R 12		31.2	Garages, multi-storey and underground car parks subject to the effects of the weather	R 12	
23.2	Working and inspection pits	R 11		31.3	Parking areas outdoors	R 11	
23.3	Car washing halls, washing areas	R 12	V 4				
24	Aircraft repair workshops						
24.1	Aircraft hangars	R 11	V 4				
24.2	Repair hangars	R 11					

VitrA kayma dayanımı

1.1.1. Kayma kiski olan çalışma odaları ve alanları (ASR A1.5/1,2'ye uygun olarak)

Özellikle çalışma alanlarındaki basma/basamak seviyesinin altındaki boşlukta dolma hacmine biriken ve kaymaya neden olan malzemelerin boşaltılması için dolma hacminin asgari hacmi bir "V" numarası ile tanımlanmaktadır.

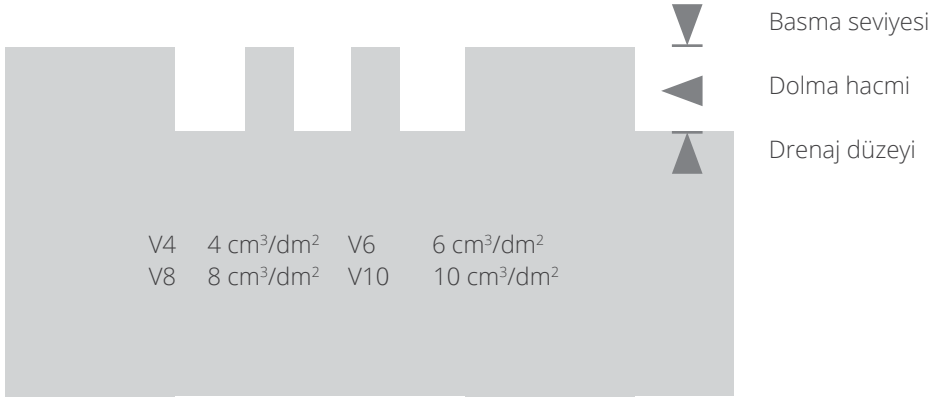

Yer değiştirme alanı (V4-V10) üzerinde yürünen üst dolaşım yüzeyi ile profilli yüzeylerin drenaj düzeyi arasındaki açıktır.

Endüstriyel alanda kayma sınıfları ve dolma hacmi - Kullanım alanları - Asr 1.5/1.2'ye uygun olarak

Nr.	Çalışma alanları, yürüme yolları	Kayma sınıfı (R grupları)	En küçük dolma hacmi	Nr.	Çalışma alanları, yürüme yolları	Kayma sınıfı (R grupları)	En küçük dolma hacmi
0	Genel çalışma odaları			95	Yemek hazırlama mutfakları (fast-food, snack bar)	R 12	
0.1	Giriş yerleri (iç)	R 9		96	Dondurulmuş ürünlerin ısıtıldığı mutfaklar	R 12	V 4
0.2	Giriş yerleri (dış)	R 11 - R 10	V 4	97	Çay ve kahve hazırlama mutfakları, garni mutfağı, koğuş mutfağı	R 10	V 4
0.3	Merdivenler (iç)	R 9		98	Bulaşık yıkama alanları	R 10	
0.4	Merdivenler (dış)	R 11 - R 10	V 4	98.1	Bulaşık yıkama alanları 9.1, 9.4, 9.5 için	R 12	
0.5	Eğimli rampalar, iç (örn. tekerlekli sandalye, tesviye yokuşu, nakliye yolları için)	R 10		98.2	Bulaşık yıkama alanları 9.2 için		
0.6	Sağlık odaları	R 9		98.3	Bulaşık yıkama alanları 9.3 için	R 11	
0.6.1	Tuvaletler			99	Yemek odaları, misafir yemek odaları, servis bankosu olan kantinler	R 12	V 4
0.6.2	Soyunma kabini veya yıkanma alanları			10	Soğuk hava ve donmuş gıda depoları	R 12	
0.7	Dirilenme odaları (örn. sosyal tesisler, kantinler)			101	Paketlenmiş malzemeler için	R 9	
0.8	İlk yardım odaları ve benzer tesisler			102	Paketlenmiş malzemeler için	R 12	
1	Margarin, yenilebilir sıvı ve katı yağ üretimi			11	Satış yerleri, dükkanlar	R 12	
11	Yağın eritilmesi	R 13	V 6	111	Et giriş	R 11	
12	Yemeklik yağ artırımı	R 13	V 4	111.1	Paketlenmiş malzemeler için		
13	Margarin üretim ve paketlenme	R 12		111.2	Paketlenmiş malzemeler için		
14	Yemeklik yağ üretimi, paketlenme, şişeleme	R 12		112	Balık girişi	R 11	
2	Süt prosesi, peynir üretimi			113	Sosis, salam, sucuk ve et için servis geçişi	R 10	
21	Taze süt işlenmesi ve tereyağı üretimi	R 12		113.1	Paketlenmiş malzemeler için	R 11	
22	Peynir üretimi, depolama ve paketlenme	R 11		113.2	Paketlenmiş malzemeler için		
23	Dondurma üretimi	R 12		114	Paketlenmiş ekmek ve unlu mamuller için servis geçişi	R 11	
3	Çikolata ve şekerleme üretimi			115	Paketlenmiş süt ürünleri ve meze için servis geçişi	R 10	
31	Şekerin işlenmesi	R 12		116	Balık servisi	R 10	
32	Kakao üretimi	R 12		116.1	Paketlenmiş malzemeler için	R 10	
33	Ham katışkıların üretimleri	R 12		116.2	Paketlenmiş malzemeler için		
34	Çubuk, kabuk ve içi doldurulmuş çikolata üretimi	R 11		117	Nr. 11.2'ten 11.6'ya kadar hariç servis geçişleri	R 12	
4	Kek, pasta ve ekmek üretimi (firınlar, pastaneler ve uzun dayanımlı unlu mamul üretimi)			118	Et hazırlama odaları	R 11	
41	Hamur hazırlama	R 11		118.1	Nr. 5 hariç et işleme (düzeltme)	R 9	
42	Yağlı ve sıvı üretimin ağır bastığı yerler	R 12		118.2	Nr. 5 hariç et işleme (işleme)		
43	Bulaşık yıkama odası	R 12	V 4	119	Çiçek buketi yapım odaları	R 12	V 8
5	Et işleme, kesimhaneler (mezbahe)			1110	Sabit fırını olan satış bölgeleri	R 11	
51	Kesim yeri	R 13	V 10	1110.1	Unlu mamullerin hazırlanması	R 11	
52	Sakatat temizleme yeri	R 13	V 10	1110.2	Önceden hazırlanmış unlu mamullerin işlenmesi		
53	Et parçalama	R 13	V 8	1111	Sabit fritözü ya da ızgarası olan satış bölgeleri	R 11	
54	Sosis, salam ve sucuk hazırlama	R 13	V 8	1112	Satış yerleri ve müşteri kabul	R 10	
55	Haşlama bölümü	R 13	V 8	1113	Self-servis yapan yerlerde yiyecek hazırlama bölümü	R 12	V 4
56	Ham üretim bölümü	R 13	V 6	1114	Kasa ve paketlenme bölümleri	R 9	
57	Sucuk, salam, sosis kurutma odası	R 12		1115	Açık alanda satış bölümleri	R 10	
58	Bağırsak deposu	R 12		12	Sağlık birimleri	R 9	
59	Tuzlama ve terbiye odası	R 12		121	Dezenfekte odaları (ıslak)	R 11 - R 10	V 4
510	Kanatlı işleme	R 12	V 6	122	Sterilizasyon için ön temizlik yerleri		
511	Soğuk kesim ve paketlenme	R 12		123	Diş atık odaları, temiz olmayan hemşirelik hizmetleri	R 11	
512	Elle işleme ve satış	R 12	V 8	124	Sektionsräume	R 10	
6	Balık işleme ve meze üretimi			125	Tıbbi banyolar, hidroterapi üniteleri	R 10	
61	Balık işlenmesi	R 13	V 10	126	Ameliyathanelerin ve alçıların yıkanma odaları	R 10	
62	Meze üretimi	R 13	V 6	127	Tuvaletler, koğuş banyoları	R 11	
63	Mayonez üretimi	R 13	V 4	128	Masaj odaları, teşhis ve terapi odaları	R 10	
7	Sabze işlenmesi			129	Ameliyathaneler	R 10	
71	Sauerkraut üretimi	R 13	V 6	1210	Hasta odaları ve koridorlar olan klinikler	R 9	
72	Konserve üretimi	R 13	V 6	1211	Muayenehaneler, gündüz klinikleri	R 9	
73	Sterilizasyon odaları	R 11		1212	Eczaneler	R 9	
74	Üretim için hazırlama	R 12	V 4	1213	Laboratuvarlar	R 9	
8	Yemek ve içecek üretimindeki ıslak zeminler (özellikle farklı bir şey belirtilmemişse)			1214	Kuaförler	R 9	
81	Kilerler, mahzenler	R 10		13	Çamaşırhaneler		
82	Meşrubat şişeleme ve meyve suyu üretimi	R 11		131	Kurutmalı (santrifüjü) çamaşır makineleri		
9	Mutfaklar ve pişirme yerleri			132	Çok ıslak çamaşırın olduğu yıkama odaları	R 9	
91	Restoran, otel mutfakları	R 11		133	Ütü ve çamaşır sıkma makinelerinin olduğu odalar	R 11	
92	Evlere, çocuk yuvalarına, sanatoryumlara servis yapan mutfaklar	R 12	V 4	14	Konsantre hayvan yemi üretimi	R 9	
93	Hastane ve klinik mutfakları	R 11	V 4	141	Kurutulmuş yem üretimi		
94	Üniversite ve büyük fabrikalara servis veren mutfaklar	R 12		142	Su ve yağ kullanılarak kurutulmuş yem üretimi		V 4

Endüstriyel alanda kayma sınıfları ve dolma hacmi - Kullanım alanları - Asr 1.5/1.2'ye uygun olarak

Nr.	Çalışma alanları, yürüme yolları	Kayma sınıfı (R grupları)	En küçük dolma hacmi	Nr.	Çalışma alanları, yürüme yolları	Kayma sınıfı (R grupları)	En küçük dolma hacmi
15	Deri üretimi, tekstil	R 11		25	Evsel atık işleme istasyonları	R 12	
15.1	Tabakhanedeki sulu yerler	R 11		25.1	Pompa odaları	R 11	V 4
15.2	Deri yüzme makinelerinin olduğu odalar			25.2	Sulu atıkların drenajı		
15.3	Deri Parçalarının toplandığı odalar	R 13	V 10	25.3	Eleme odaları	R 12	
15.4	Derilerin empraye yapıldığı yerler	R 13	V 10	25.4	Ayakta durulan yerler ve bekleme odaları	R 12	
15.5	Tekstil için boya değirmenlerinin olduğu yerler	R 13		26	İtfaiye binaları	R 12	
16	Cila atölyeleri	R 12		26.1	Araç parkı	R 12	
16.1	Sulu öğütme atölyeleri	R 11		26.2	Hortum bakım atölyesi		
17	Seramik endüstrisi			27	Solunum cihazları eğitim tesisinde işlevsel odalar	R 12	
17.1	Islak değirmenler (seramik hammaddenin hazırlanması)	R 12		27.1	Hazırlık odası	R 12	
17.2	Karıştırıcılar, zift, grafit ve sentetik malzemelerin kullanıldığı yerler		V 10	27.2	Havalandırma odası		
17.3	Şekillendirme presleri zift, grafit ve sentetik malzemelerin kullanıldığı yerler	R 11		27.3	Eğitim odası	R 9	
17.4	Döküm / pres döküm alanları	R 11	V 6	27.4	Hava hücresi		
17.5	Sırlama	R 11	V 6	27.5	Model ev		
18	Cam ve taş prosesi	R 12		27.6	Sıcak iklimi alıştırmaya odaları		
18.1	Taş kesme ve öğütme yeri	R 12		27.7	Denetim istasyonu		V 4
18.2	Her türlü cam şekillendirme alanı			28	Okullar ve kreşler		V 4
18.3	Öğütme yerleri	R 11		28.1	Sınıflar, grup odaları		
18.4	İzolasyon camı üretiminde kurutucu malzemelerin işlendiği yerler	R 11		28.2	Merdivenler		
18.5	Düz camın paketlenmesi ve yüklediği yerler, yapışmayı önleyici malzemelerin hazırlandığı yerler	R 11	V 6	28.3	Tuvaletler, yıkama odaları	R 10	
18.6	Asitli indirme yapılan yerler	R 11	V 6	28.4	Okullardaki eğitici mutfaklar (bkz. Nr. 9)	R 11 - R 10	
19	Prefabrik beton fabrikaları			28.5	Çocuk yuvalarındaki mutfaklar (bkz. Nr. 9)	R 11 - R 10	
19.1	Beton yıkama yerleri	R 11		28.6	Aşap işleme makinelerinin olduğu odalar		
20	Depolar			28.7	El sanatları için özel odalar	R 9	
20.1	Likit ve katı yağlar için stok sahaları	R 11		28.8	Teneffüs alanları	R 9	
20.2	Paketlenmiş yiyeceklerin stok sahaları			29	Bankalar	R 9	
20.3	Açık alandaki stok sahaları	R 12		29.1	Banka vezneleri	R 10	V 4
21	Demir ve metalin kimyasal ve ısı işlem prosesi	R 10	V 6	30	Dış mekânlardaki işletmeyle ilgili yollar	R 10	
21.1	Beizeisen	R 11 - R 10		30.1	Yürüme yolları	R 10	V 4
21.2	Sertleştirme prosesi		V 4	30.2	Yükleme rampaları	R 10	
21.3	Laboratuvarlar	R 12		30.2.1	Örtülü	R 10	V 4
22	Metal prosesi, metal atölyeleri	R 12		30.2.2	Açık	R 11 - R 10	V 4
22.1	Galvanize atölyeleri	R 11		30.3	Eğik rampalar (örn. tekerlekli sandalyeler, yükleme köprüleri için)		
22.2	Graugussbearbeitung	R 11		30.4	Üstü kapalı	R 11 - R 10	
22.3	Mekanik proses (torna, pres yerleri) tel boru çekme yerleri, yağlı ortamdan dolayı riskin fazla olduğu ortamlar	R 12		30.4.2	Üstü açık		
22.4	Parça temizleme yerleri, buhar çıkışının olduğu odalar	R 11	V 4	31	Park alanları	R 11 - R 10	
23	Araç bakım yerleri			31.1	Garajlar, hava koşullarından etkilenmeyen çok katlı ve yeraltı otoparkları	R 12	
23.1	Bakım ve servis alanı	R 12		31.2	Garajlar, hava koşullarından etkisinde kalan çok katlı ve yeraltı otoparkları	R 12	
23.2	Çalışma ve kontrol alanı			31.3	Açık park alanları	R 11	
23.3	Araç yıkama yerleri	R 11					
24	Uçak bakım atölyeleri	R 12	V 4				
24.1	Uçak hangarları	R 11	V 4				
24.2	Uçak bakım ve tamir hangarları						
24.3	Uçak yıkama yerleri	R 11					

VitrA slip resistance

1.2. Slip-resistance properties in barefoot areas

DIN 51097 is the test method that is used for determining slip resistance of floor coverings in wet barefoot areas subject to risk of slipping. According to DIN 51097, there are three assessment groups on the basis of size and the risk of slipping in wet barefoot areas. The lowest slip resistance value is A, whereas the highest one is C for classification of barefoot slip resistance of tiles. In the following table of barefoot areas slip resistance classification, the application areas are indicated in accordance with the leaflet "DGUV Information 207-006 - Floor coverings for wet barefoot areas".

Wet barefoot areas slip resistance classification and application areas

Class	Min. degree of slope	Areas
A	12°	<ul style="list-style-type: none">- Barefoot passages and sanitary areas (mainly dry)- Individual and common dressing rooms- Pool floors in non-swimmer areas if the water depth is more than 80 cm in the entire area- Sauna and relaxation areas (mainly dry)
B	18°	<ul style="list-style-type: none">- Barefoot passages and sanitary areas, if not classified in group A- Showers- Steam baths- Area of disinfecting spray facilities- Pool surrounds- Pool floors in non-swimmer areas if the water depth is less than 80 cm in certain areas- Non-swimmer sections of wave-action pools- Movable floors- Paddling pools- Ladders and stairs outside the pool area, if not classified in group C- Accessible surfaces of diving platforms and diving boards, if not classified in group C- Sauna and relaxation areas, if not classified in group A
C	24°	<ul style="list-style-type: none">- Ladders and stairs leading into the water- Stairs up to diving facilities and water slides- Surfaces of diving platforms and diving boards over the length reserved for the diver (the slip-resistant surface of the diving platforms and diving boards must cover the front edge where the hands and the toes of the divers grip)- Walk-through pools- Inclined pool edge designs- Kneipp pools, water-treading pools- Ramps in the pool surround area with an inclination > 6 %

Important notice: The indicated angles of inclination helps to identify anti-slip classification of the product and cannot be related to the angles of inclination of slopes/ramps.

VitrA kayma dayanımı

1.2. Çıplak ayaklı alanlardaki kayma dayanım özellikleri

DIN 51097, kayma riski olan ıslak çıplak ayaklı alanlardaki zemin kaplamalarının kayma dayanımının belirlenmesi için kullanılan test yöntemidir. DIN 51097'ye göre, ıslak çıplak ayaklı alanlarda kayma riskine göre üç değerlendirme grubu bulunmaktadır. Karoların çıplak ayaklı kayma dayanımı sınıflandırması için en düşük kayma dayanım değeri A iken en yüksek olanı C'dir.

Çıplak ayaklı alanların kayma dayanım sınıflandırması ile ilgili aşağıdaki tabloda, uygulama alanları "DGUV Bilgileri 207-006 – Islak çıplak ayak alanlar için zemin kaplamaları" kitapçığına göre belirlenmiştir.

Wet barefoot areas slip resistance classification and application areas

Class	Min. degree of slope	Areas
A	12°	<ul style="list-style-type: none">- Çıplak ayaklı geçişler ve sıhhi bölgeler (esas kuru olarak)- Bireysel ve ortak giyinme odaları- Eğer su derinliği tüm alanda 80 cm'den fazlaysa, yüzücüler için olmayan alanlardaki havuz zeminleri- Sauna ve rahatlama alanları (esas olarak kuru olanlar)
B	18°	<ul style="list-style-type: none">- Eğer grup A içinde sınıflandırılmamışsa çıplak alan geçişleri ve sıhhi alanlar- Duşlar- Buhar banyoları- Dezenfektan sprej imkanları alanı- Havuz çevreleri- Belirli alanlarda su derinliği 80 cm'den azsa yüzücülerin olmadığı alandaki havuz zeminleri- Dalga hareketli havuzlarda yüzücüler için olmayan alanlar- Hareket edebilen zeminler- Çocuk havuzları- Eğer C grubu içinde sınıflandırılmamışsa havuz alanı dışındaki merdivenler ve basamaklar- Eğer C grubu içinde sınıflandırılmamışsa dalış platformları ve dalış tahtalarının erişilebilir yüzeyleri- Eğer A grubu içinde sınıflandırılmamışsa sauna ve rahatlama alanları
C	24°	<ul style="list-style-type: none">- Suya gidiş merdivenleri ve basamakları- Dalış alanlarına ve su kaydıraklarına giden merdiven basamakları- Dalıcı için ayrılan uzunluk üzerindeki dalış platformlarının ve dalış tahtalarının yüzeyleri (Dalış platformlarının ve dalış tahtalarının kaymaya dayanıklı yüzeyleri dalıcıların ellerinin ve ayak parmaklarının kavradığı ön kısmı kaplamalıdır.)- İçinden yürünebilen havuzlar- Eğimli havuz kenar tasarımları- Kneipp havuzları, su basamak havuzları- Havuzdaki rampalar alanı > 6 % eğimi ile çevrelemektedir.

Önemli not: Belirlenen eğim açıları ürünün kaymazlık sınıflandırmasını tanımlamaya yardımcı olurlar ve bunlar eğimlerin / rampaların eğim açıları ile ilişkilendirilemezler.

VitrA slip resistance

2. Pendulum

The pendulum CoF test (also known as the portable skid resistance tester, the British pendulum, and the TRRL pendulum) is the subject of a British Standard, BS 7976: Parts 1-3, 2002.

Information generated by the pendulum using Slider 96 rubber, also known as Four-S rubber (Standard Simulated Shoe Sole) is sufficient for assessing slipperiness in most circumstances. However, for assessing barefoot areas, unusually rough or profiled floors, the use of Slider 55 rubber, also known as TRRL rubber (a similar but softer, more malleable compound) may be advantageous.

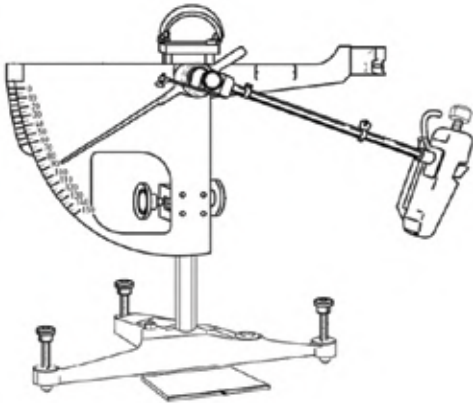

Pendulum CoF Test (Diagram adapted from BS 7976-1:2002 Pendulum testers - Part 1: Specification)

Slip Potential Classification, based on pendulum test values (PTV) (from UKSRG, 2011)	
	PTV
High Slip Potential	0-24
Moderate Slip Potential	25-35
Low Slip Potential	36 +

3. DCOF

DCOF is the ratio of the force necessary to keep a surface already in motion sliding over another divided by the weight (or normal force) of an object. This force is a materials property of the two surfaces. Contaminants such as dirt, water, soap, oil or grease can change this value. The test is done according to standards of ANSI A137.1 and ANSI A326.3.

Unless otherwise specified, tiles suitable for level interior spaces expected to be walked upon when wet shall have a wet DCOF of 0,42 or greater when tested using SLS solution. However, tiles with a DCOF of 0,42 or greater are not necessarily suitable for all projects. The specifier shall determine tiles appropriate for specific project conditions, considering by way of example, but not in limitation, type of use, traffic, expected contaminants, expected maintenance, expected wear and manufacturers' guidelines and recommendations. (Ref: ANSI A137.1-2017)

VitrA tile size information

The tile format is given as a nominal dimension, which is calculated by the work size (aspired manufacturing size) plus the recommended joint width. The content within the box is printed as square-meter on box label and is calculated from the nominal size which is achieved with the use of appropriate joint width.

In the industrial manufacture of tiles, variations in the size (calibre) of the tiles are inevitable for non-rectified tiles. The sizes are sorted, labelled and boxed separately. The calibre code is printed on each box label and specifies the actual size of the tile as below:

M30x60 Ultra 2.0 Mink R10B nR

Quality: 1 Tone/Shade: VA2

Caliber: 4

K95023100001VTE0

2.22.56.47 GL

P. Date: 01.01.2021

MADE IN TURKEY 8

Label on the box

M30cm x 60cm		
Contents Inhalt Miktar Количество	1.08m²	Pieces Stück Adet Штук
	6	GL/UGL
EN 14411:2016-Group Bla-Annex G		w: (mm)
		3: 296,0x595,4x9mm
		4: 297,0x597,0x9mm
		5: 298,0x598,6x9mm
		6: 299,0x600,2x9mm
Прессованная сухим способом плитка гост 6787-2001		

Information on the box

*The labels shown are for information only and the contents of the labels are not binding.

VitrA kayma dayanımı

2. Pendulum

Pendulum CoF testi (Ayrıca taşınabilen kayma direnci test cihazı, İngiliz pendulumu ve TRRL pendulumu olarak da adlandırılmıştır) bir İngiliz Standardı olan BS 7976:1-3 kısımları, 2002'ye tabidir.

Four-S kauçuğu olarak da bilinen Slider 96 kauçuğu kullanılarak pendulumdan elde edilen bilgiler (Standart simüle edilen ayakkabı tabanı) ortamların çoğunda kayganlığın değerlendirilmesi için yeterlidir. Fakat çıplak ayaklı alanların değerlendirilmesinde, alışılmadık şekilde pürüzlü veya profilli olan zeminlerde TRRL kauçuğu olarak da bilinen Slider 55 kauçuğun kullanımı avantajlı olabilecektir (benzer ama daha yumuşak olan daha şekil verilebilir bir bileşen).

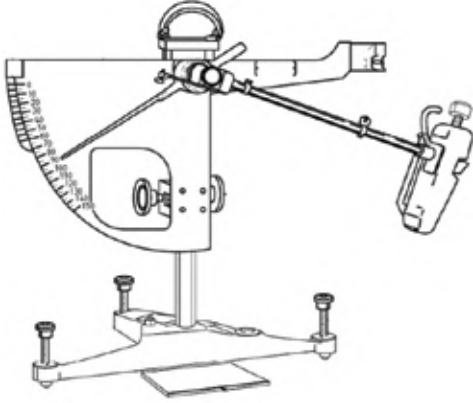

Pendulum CoF Testi (BS 7976-1:2002 Pendulum test cihazlarından uyarlanan diyagram – 1.Kısım: Özellikler)

(PTV) (UKSRG, 2011'den) Pendulum test değerlerine dayalı olarak kayma potansiyeli sınıflandırması

	PTV
Yüksek Kayma Potansiyeli	0-24
Orta Düzeyde Kayma Potansiyeli	25-35
Düşük Düzeyde Kayma Potansiyeli	36 +

3. DCOF

DCOF, hareket halinde olan bir yüzeyin üzerinde bulunan yüzey üzerinden kayması için gereken gücün bir nesnenin ağırlığına (veya normal güç) bölünmesi ile elde edilen orandır. Bu güç iki yüzeyin maddesel özelliğidir. Kir, su, sabun, yağ veya motor yağı gibi kontaminasyonlar bu değeri değiştirebilirler. Test ANSI A137.1 ve ANSI A326.3 standartlarına göre yapılmaktadır.

Aksi belirtilmedikçe, yüzeyler ıslak olduklarında üzerinde yürünmeye uygun olan karolar SLS solüsyonu ile test edildiklerinden 0,42 veya daha büyük ıslaklık DCOF değerine sahip olacaklardır. Fakat DCOF değeri 0,42 veya üzerinde olan karoların tüm projeler için uygun olduğunu belirtmek mümkün değildir. Belli proje koşulları için uygun olan karolar, karo seçimini gerçekleştirirken belirlenmelidir. Örnek olarak kullanım çeşidi, trafik, beklenen kirlendiriciler, beklenen bakım, beklenen aşınma ve üreticilerin tavsiyeleri ve kılavuzları dikkate alınmalıdır. (Ref: ANSI A137.1-2017)

VitrA karo ebat bilgileri

Karo boyutu, çalışma boyutu ve önerilen derz aralığı ile hesaplanan anma boyutu olarak ifade edilir. Kutu içindeki miktar, kutu etiketinde metrekare olarak basılır ve uygun derz aralığı ile döşenmesinden elde edilen anma boyutundan hesaplanır.

Endüstriyel karo üretiminde, karoların boyutlarındaki (kalibre) farklılıklar, rektifiye olmayan karolar için kaçınılmazdır. Boyutlar kalibrelerine göre ayrı ayrı sıralanır, etiketlenir ve kutulanır. Kalibre numarası her kutu etiketinde basılıdır ve aşağıdaki örnekte olduğu gibi karonun gerçek boyutunu ifade eder:

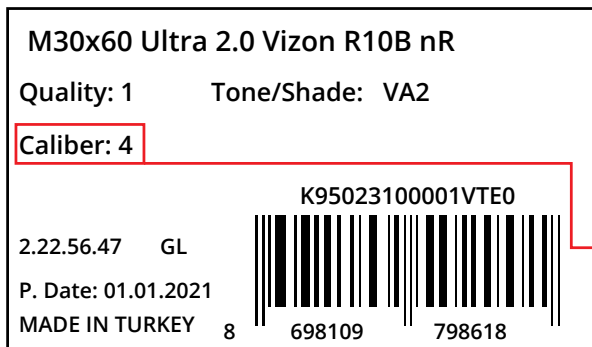

Kutu üzeri etiket

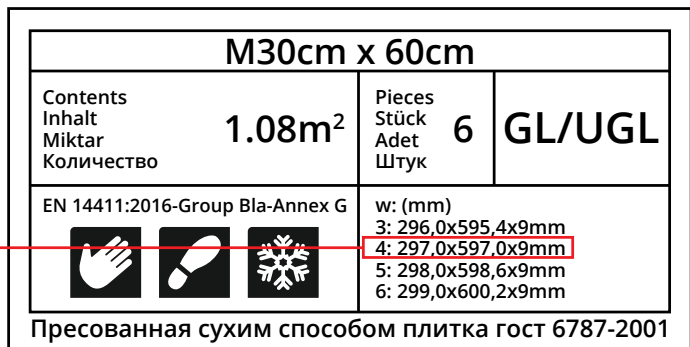

Kutu üzeri bilgi

* Gösterilen etiketler sadece bilgi amaçlıdır ve etiketlerin içeriği bağlayıcı değildir.

VitrA cleaning and care instructions

1. General information

VitrA Tiles are produced utilizing the most advanced equipment under extensive and strict process controls. Quality is assured with sourcing the finest raw materials available in the market. VitrA continuously focuses on maintaining its commitment to quality so that our products meet and exceed your expectations.

Market research studies and tests prove that ceramic displays excellent properties compared to other covering materials. Its long lasting beauty, ease of cleaning and high functionality are what makes ceramic tiles the most chosen covering material in both private and public areas. All glazed and unglazed materials are distinguished by surfaces which are ideal for easy cleaning. As with every covering material, our products require nominal care in order to maintain a satisfactory appearance and acceptable sanitation for years.

As a company committed to sustainability, VitrA recommends the use of low VOC, non-hazardous, and non-polluting products for cleaning and maintaining tiles and grout.

Regular cleaning has to be planned according to the needs, depending on the degree of soiling and frequency of use: could be several times a day or once a day or once a week. For public use, shoe-scrapers, doormats and cleaning zones for shoes in front of the entrance of the building ensure that most dirt is left outside. VitrA recommends proper selection of such preventive elements for the sake of minimizing the use of cleaning agents and impact on environment. Before grouting, regardless of the grout colour chosen, always test a small area first to determine if the grout or grout pigment will affect the surface of the tile.

1.1 Proper care during construction

Since VitrA products are considered to be a finish covering material, they should not be laid until all heavy construction is finished. Between the installation and putting the tiled area into service, it is imperative to properly protect the tile and grout in order to avoid construction related cleaning problems. There is a build-up of dirt and debris on each construction site. This dirt and debris may cause the grout, and sometimes the tile, to be negatively affected. VitrA recommends that a protective cover be put over the tile surface to safeguard the appearance. This will insure a quality appearance when the floor is ready for use. The protective cover could be cardboard, plywood or any other clean soft-covering that will not damage the integrity of the installation. Do not use plastic as it may not allow the grout to properly cure, and it also may become extremely slippery as construction dust settles on the floor.

1.2 Proper selection and use of cleaning agent

Use only recommended dilution of detergent. As an important rule, more is not always better; higher concentrations of detergent in the cleaning solution would only make it more difficult to rinse. However, hard water requires more frequent use of cleaning agents. When using any cleaning agent, please make sure to comply with the instructions for use and hazard indications of the cleaning agent manufacturer. VitrA does not assume any liability for damage incurred by non-compliance with these instructions and information.

The detergent solution must be given time to act on the soil load. Generally 5-10 minutes is sufficient. Rinse thoroughly with clean, clear water to remove the dirty detergent solution and soil. Rinsing is a critical step in the maintenance procedure. Remove the rinse water with a wet vacuum, dry mop or towelling. If dirty detergent solution is not removed and is allowed to dry on the surface, a coating will form which is very difficult to remove.

1.2.1. Warnings for proper selection and use of cleaning agent:

- 1) VitrA tiles are chemically resistant to both acidic and alkaline chemical products as defined in EN ISO 10545-13, with the exception of hydrofluoric acids or compounds containing fluoride salts and derivatives. Hydrofluoric acid is the only one that will attack tiles due to their molecular structure, even when diluted with plenty of water. All spills must be cleaned as quickly as possible
- 2) Never use a cleaning agent forming sticky grease, wax and synthetic layers on the tiles, which have a negative effect on the visual, hygienic, anti-slip and cleaning properties. The cleaning agent that is chosen should also be compatible with the grout at the same time. Always test a small area first with the selected cleaning agent.

1.3 General cleaning procedure

The following principles apply for the cleaning procedure:

1. Selecting the appropriate cleaning agent.
2. Sweeping or vacuuming floor areas prior to cleaning to remove any dust or debris.
3. Leaving the cleaning agent to act for sufficient time upon the dirt and to loosen it.
4. Brushing or wiping mechanically.
5. Collecting, washing or sucking off the dirt separated from the tiles thoroughly.
6. Rinsing with water when the cleaning process is finished.
7. Removing the rinse water with a wet vacuum, dry mop or towelling.

Above are general recommendations. Any specific recommendations of cleaning agents, grout, grout removers etc. suggested by the individual manufacturer should be followed.

VitrA temizlik ve bakım talimatları

1.Genel bilgiler

VitrA karolar, en gelişmiş ekipmanlar kullanılarak, kapsamlı ve sıkı önlemler ile takip edilen proses kontrolleri altında üretilmektedir. Piyasadaki en iyi hammaddelerin tedarik edilmesiyle kalite, güvence altına alınmıştır. VitrA, sürekli olarak kaliteye olan bağlılığını sürdürmeye odaklanmakta, böylece ürünlerimiz beklentilerinizi karşılamakta ve beklentilerinizin ötesine geçmektedir.

Pazar araştırma çalışmaları ve testler, seramiklerin diğer kaplama malzemelerine kıyasla mükemmel özellikler sergilediğini kanıtlamaktadır. Uzun ömürlü görsel güzelliği, temizlik kolaylığı ve yüksek işlevsellik, seramik karoları hem özel (kişisel kullanım) hem de kamusal alanlarda en çok tercih edilen yüzey döşeme malzemesi yapan şeydir. Tüm Sırlı ve sırsız karolar, kolay temizlik için ideal yüzey özellikleri ile ayırt edicidir. Her kaplama malzemesinde olduğu gibi, ürünlerimiz yıllarca tatmin edici temiz bir görünüm sağlamak için bakım gerektirir. Sürdürülebilirliğe önem veren bir şirket olarak VitrA, karo ve derzlerin temizlenmesi ve bakımı için düşük VOC, tehlikeli olmayan ve kirlenmeyi önleyen ürünlerin kullanılmasını önermektedir.

Düzenli temizlik: kirlilik derecesine ve kullanım sıklığına bağlı olarak ihtiyaçlara göre planlanmalıdır: günde birkaç kez veya günde bir kez veya haftada bir kez olabilir. Kamusal alanlardaki kullanımı için, ayakkabılardaki kirin binanın girişinin önünde bulunan çamurluk, paspaslar ve temizleme bölgeleri ile dışarıda kalması sağlanmalıdır. VitrA, temizlik maddelerinin kullanımını ve çevreye olan etkiyi en aza indirmek amacıyla bu tür kirlenmeyi önleyici öğelerin uygun şekilde seçilmesini önermektedir.

Döşmeden önce, seçilen derz renginden bağımsız olarak, her zaman, harç veya harç pigmentinin karo yüzeyini etkileyip etkilemeyeceğini belirlemek için küçük bir alan test edilmelidir.

1.1. Döşeme - inşaat sırasında bakım

VitrA ürünleri son kaplama malzemesi olarak kabul edildiğinden, tüm ağır işler bitene kadar döşenmemelidir. İnşaat kaynaklı temizlik sorunlarından kaçınmak için döşenen alan kullanıma açık hale gelene kadar döşenen alandaki karoları ve derz dolgularını uygun bir şekilde korumak gereklidir. Her şantiyede kir ve kalıntı birikir ve bu biriken kirler/kalıntılar, derzin ve bazen de karoların olumsuz etkilenmesine neden olabilir. VitrA, bu durumu önlemek ve döşendikten sonraki görünümü korumak için döşeme alanı üzerine koruyucu bir malzeme serilmesini önerir. Bu sayede döşenmiş alanın kalitesi kullanıma hazır oluncaya kadar korunacaktır. Koruyucu malzeme olarak mukavva, karton, kontrplak veya döşemenin bütünlüğüne zarar vermeyecek herhangi temiz ve yumuşak bir malzeme kullanılabilir. Derzlerin düzgün bir şekilde kuruyup sertleşmesine izin vermeyeceği ve inşaat tozunun üzerine yapışarak kaygan bir alan oluşturabileceği için plastik korumalar kullanılmamalıdır.

1.2. Uygun malzeme seçimi ve temizleme maddesi kullanımı

Sadece önerilen miktarda seyreltilmiş deterjan kullanılmalıdır. Unutulmamalıdır ki temizlik malzemelerinin fazlası her zaman için iyi değildir; temizleme çözeltilisinde daha yüksek deterjan konsantrasyonları kullanmak durulamayı zorlaştıracaktır. Bununla birlikte, suyun sertliğinin artması daha fazla temizlik maddelerinin kullanılmasına neden olur. Herhangi bir temizlik maddesini kullanırken, lütfen temizlik maddesi üreticisinin kullanım ve tehlike göstergelerine uygun olarak kullanıldığından emin olun. VitrA, temizlik maddesi üreticileri tarafından verilen talimatlara ve bilgilere uyulmamasından kaynaklanan hasarlar için herhangi bir sorumluluk kabul etmemektedir. Kirliliğe etki etmesi için temizlik maddeleri kirliliği alan üzerinde bir süre bekletilmelidir. Genellikle 5-10 dakika yeterlidir. Kirliliği alan üzerindeki deterjanı ve kirleri arındırmak ve temizlemek için temiz su ile bölgeyi iyice durulayın. Durulama, bakım prosedüründe kritik bir adımdır. Durulama için kullanılan suyu yerden vakumla, kuru paspasla veya bezle temizleyin. Kirliliği deterjan çözümü durulanmazsa ve yüzeyde kurumaya bırakılırsa, yüzey üzerinde çıkarılması çok zor olan bir kaplama oluşacaktır.

1.2.1. Temizlik maddelerinin uygun seçimi ve kullanımı için uyarılar:

- 1) VitrA karolar, hidroflorik asitler veya florür tuzları ve türevleri içeren bileşikler dışında, EN ISO 10545-13'te tanımlanan hem asidik hem de alkali kimyasallara dayanıklıdır. Hidroflorik asit, bol su ile seyreltildiğinde bile, moleküler yapıları nedeniyle karolara zarar veren tek örnektir. Herhangi bir malzeme döküldüğünde mümkün olduğunca çabuk temizlenmelidir.
- 2) Karolar üzerinde görsel, hijyenik, kayma dayanımı ve temizleme özelliklerini olumsuz etkileyecek, yapışkan yağlı, mumsu ve sentetik tabakalar oluşturacak bir temizlik maddesi kullanmayın. Seçilen temizlik maddesi aynı zamanda harçla da uyumlu olmalıdır. Her zaman kullanım öncesi seçilen temizlik maddesiyle küçük bir alan test edilmelidir.

1.3.Genel temizlik talimatları

Temizlik prosedürü için aşağıdaki kurallara uyulmalıdır:

1. Uygun temizlik maddesi seçilmelidir.
2. Toz veya kalıntıları temizlemek için temizlikten önce zemin süpürülmelidir.
3. Temizlik maddesi kir üzerine temas etmesi ve yok etmesi için yeterli süre üzerinde bekletilmelidir.
4. Mekanik bir fırçalama işlemi veya silme işlemi yapılmalıdır.
5. Karolardan çıkan kirler toplanmalı, yıkanmalı veya vakumlanmalıdır.
6. Temizleme işlemi bittiğinde su ile durulanmalıdır.
7. Durulama suyu ıslak bir vakum, kuru paspas veya bez ile alınmalıdır.

Yukarıda bahsi geçen prosedür içeriği genel önerileri kapsamaktadır. Bireysel üreticiler tarafından önerilen temizlik maddeleri, derz, derz temizleyiciler vb. özel tavsiyeler uygulanmalıdır.

VitrA cleaning and care instructions

2. First cleaning after installation

The first step for maintenance is complete removal of grout and construction dirt after tiles are laid. To remove the grout from the surface, there are many products available in the market. These products can be diluted for removal of light deposits of grouting materials with the possibility of using higher concentrations when aggressive cleaning is required. Grout manufacturers print instructions for proper mixing, curing, and cleaning of grout on packaging, these must be followed. This cleaning must be carried out after the cement grout has dried out, which takes at least 24-48 hours for quicksetting and quick-drying products. In any case the grout manufacturer's instructions must be followed. In most cases, VitrA tiles can be cleaned successfully by scrubbing the installation with hot water and a neutral detergent, followed by a thorough rinsing and then removing the rinse water with a wet vacuum, mop or dry towelling. If grout residue still remains, further cleaning of the tile should be accomplished in consultation with the grout manufacturer. Once the initial cleaning has been thoroughly completed, daily maintenance procedures can be followed for continuous and long-lasting beauty.

For polished Porcelain tiles, following the completion of the grouting process, the tile surface can be cleaned and any excess protective sealer removed. Use dry and wet cloth (such as MICROFIBER) in order to remove excess, if needed, add neutral detergent according to manufacturer's instruction, help removing the residue. Always test a small area first. Wipe up the residue with a cotton towel or sponge. Rinse thoroughly with clean water.

In the case of anti-slip surfaces, mechanical cleaning by means of brushing machines with rotating soft nylon brushes or microfiber as well as high-pressure or vapour pressure cleaners is most effective, whereby joints must be cared during cleaning process. During the cleaning do not use improper pads or brushes with abrasive grain as they can significantly weaken non-slip safety!

2.1 General first cleaning after installation procedure

Cleaning should be carried out by the professionals who have installed the material:

1. Sweep/vacuum the floor thoroughly to remove construction dust
2. Dilute the cement film remover in water as instructed on the package
3. Apply the cleaning product with an ordinary mop
4. Leave to act for a few minutes
5. Rub the zones with the toughest deposits hard with an abrasive sponge such as Scotch-Brite
6. Wipe up the residues using cloth and rinse with plenty of clean water and dry with mop, wet vacuum or towel.

Warnings for first cleaning after installation:

- 1) First cleaning after installation can damage objects close to the tiled area; such as doors, metallic objects and finishes; it is recommended to protect these before starting the cleaning operation.
- 2) Acid cleaners attack cement joints. Therefore, protect the joints by dampening with water and thoroughly rinse the covering with clear water after the use of acid cleaners, neutralise if possible. When using epoxy grouts, use a specially formulated cleaner and strictly follow the manufacturer's instructions for preparation, application and cleaning.
- 3) Especially for metallic tiles and tiles with metallic decors, use only non-acidic grout cleaners, always handle with maximum care. Water should be first option. If a stronger cleaning is needed clean with alcohol and a soft cloth or alternatively use a neutral PH. Avoid abrasive, acidic or alkaline cleaning products. Use a slightly damp sponge to clean the tile joints, passing it diagonally across them. Do not use dirty water.
- 4) Never clean tiles that are too hot (e.g. exposed to sunlight during hot summer days) since the reaction of chemicals may become harsher. In the summer, cleaning should be done during the coolest period of the day especially on areas exposed to direct sunlight.

3. Regular cleaning

3.0. General rules

Two methods are customarily used:

- 1) Manual cleaning using a broom, scrubbing brush or a mop.
- 2) Machine cleaning using a disc machine, scrubbing suction machine or high-pressure cleaner with spray injection.

Manual cleaning is recommended for only little dirt. When machines are used, single-disc or multi-disc machines or brush/scrubber suction machines are most effective options. High-pressure cleaners with spray injection are particularly suitable for slip-resistant surfaces. Which is the most rational method for these surfaces.

VitrA temizlik ve bakım talimatları

2. Döşeme sonrası ilk temizlik

Bakım için ilk adım, karo döşendikten sonra harç ve inşaat kirinin tamamen temizlenmesidir. Derzleri yüzeyden çıkarmak için piyasada birçok ürün bulunmaktadır. Bu ürünler, yoğun temizlik gerektiğinde daha yüksek konsantrasyonlar kullanma olasılığı ile derz dolgu malzemelerinin daha az birikmesi için seyreltilirler. Derz üreticileri tarafından ambalaj üzerinde harçların uygun şekilde karıştırılması, sertleşmesi ve temizlenmesi için talimatlar yazılır, bu talimatlar uygulanmalıdır. Temizleme işlemi; çimento harçları kuruduktan sonra yapılmalıdır. Çabuk kuruyan ürünler için en az 24-48 saat sonra yapılmalıdır. Her koşulda, derz üreticisinin talimatları takip edilmelidir. VitrA karolar, çoğu durumda, sıcak su ve nötr bir deterjan ile ovularak temizlenir, ardından iyice durulanır ve daha sonra durulama suyunun ıslak vakum, paspas veya kuru havlu ile çıkarılması sağlanmalıdır. Derz kalıntısı hala mevcut ise, karonun temizlenmesi, derz üreticisine danışılarak gerçekleştirilmelidir. İlk temizlik tamamlandıktan sonra, sürekli ve uzun ömürlü güzel görünüm için günlük bakım prosedürleri takip edilmelidir.

Parlatılmış Porselen karolar için, derz işleminin tamamlanmasından sonra, karo yüzeyi temizlenebilir ve yüzeydeki fazla koruyucu kaplama maddesi çıkarılabilir. Gerekirse yüzeydeki fazlalığı gidermek için kuru ve ıslak bir bez kullanılmalıdır (örn. MICROFIBER), üreticinin talimatlarına göre nötr deterjan eklenmeli, kalıntıların giderilmesi sağlanmalıdır. Her zaman önce küçük bir alan test edilmelidir. Kalıntı, pamuklu bir havlu/bez veya süngerle silinmeli ve temiz su ile iyice durulanmalıdır.

Kayma dayanımı olan yüzeylerde, dönen yumuşak naylon fırçalar veya mikrofiber içeren fırçalama makinelerinin yanı sıra yüksek basınçlı veya buhar basınçlı temizleyiciler ile mekanik temizlik etkili yöntemdir, bu sayede temizlik işlemi sırasında derzler korunmaktadır. Temizlik sırasında kayma dayanımını önemli ölçüde zayıflatabilecekleri için aşındırıcı taneli, uygun olmayan ped veya fırça kullanılmamalıdır!

2.1. Döşeme sonrası genel ilk temizlik talimatı

Temizlik işlemi, döşemeyi yapmış profesyoneller tarafından yapılmalıdır:

1. İnşaat tozunu temizlemek için zemin iyice süpürülmelidir.
2. Çimento film temizleyici, pakette belirtildiği şekilde suyla seyreltilmelidir.
3. Temizlik ürünü sıradan bir paspas ile uygulanmalıdır.
4. Etki etmesi için birkaç dakika beklenmelidir.
5. Scotch-Brite gibi aşındırıcı bir süngerle sertleşmiş bölgeler ovalanmalıdır.
6. Kalıntılar bezle silinmeli ve bolca temiz su ile durulanmalı ve paspas, ıslak vakum veya havlu ile kurulanmalıdır.

2.1.1. Döşeme sonrası ilk temizlik için uyarılar:

1. Döşeme sonrası ilk temizlik, karo ile döşenmiş alana yakın nesnelere; kapılar, metalik objeler ve cilalar vb. zarar verebilir. Temizlik işlemine başlamadan önce bunların korunması tavsiye edilir.
2. Asit içerikli temizleyiciler çimento derzlerine etki eder. Bu nedenle derzler su ile nemlendirerek korunmalı ve asit temizleyicileri kullanıldıktan sonra kaplama temiz suyla iyice durulanmalı, mümkünse nötr hale getirilmelidir. Epoksi harçlar kullanılırken, özel olarak formüle edilmiş bir temizleyici kullanılmalı ve harç üreticisinin hazırlık, uygulama ve temizlik için talimatları uygulanmalıdır.
3. Özellikle metalik karolar ve metalik dekorlu karolar için, asidik olmayan derz temizleyicileri kullanılmalı, daima maksimum özen gösterilmelidir. Temizlik için ilk seçenek su olmalıdır. Daha güçlü bir temizleme gerekirse, alkol ve yumuşak bir bezle temizlenmeli veya alternatif olarak nötr PH içeren temizlik malzemeleri kullanılmalıdır. Aşındırıcı, asidik veya alkali temizlik ürünlerinden kaçınılmalıdır. Karo derzlerini temizlemek için hafifçe nemli bir sünger kullanılmalı ve diyagonal olarak uygulanmalıdır. Kirli su kullanılmamalıdır.
4. Sıcak ile birlikte kimyasalların reaksiyonu daha sert/aşındırıcı hale gelebileceğinden, çok sıcak olan (sıcak yaz günlerinde güneş ışığına maruz kalan) karolar asla temizlenmemelidir. Yaz aylarında, günün en serin döneminde, özellikle doğrudan güneş ışığına maruz kalınmayan zamanlarda temizlik yapılmalıdır.

3. Düzenli temizlik

3.0. Genel kurallar

Genellikle iki yöntem kullanılır:

- 1) Süpürge, ovma fırçası veya paspas kullanarak manuel olarak yapılan temizlik.
- 2) Makine yardımıyla temizleme; bir disk makinesi, vakum makinesi veya yüksek basınçlı temizleyiciyi sprey enjeksiyonuyla temizleme. Elle temizlik sadece az miktardaki kirler için önerilir. Makineler kullanıldığında, tek diskli veya çok diskli makineler veya fırça/ovalayıcı vakum makineleri en etkili seçeneklerdir. Sprey enjeksiyonlu yüksek basınçlı temizleyiciler, kaymaya dayanıklı yüzeyler için özellikle uygundur.

VitrA cleaning and care instructions

3.0.1. Warnings for regular cleaning:

- 1) All of the information provided about cleaning, care and removing stains from ceramic tiles is based on the latest knowledge and material. It is, however, a general information and cannot cover every single possibility. Therefore, please pay attention to the instructions provided by the cleaning agent and grout manufacturer.
- 2) Routine cleaners should never contain acids or ammonia. Acids can damage the grout and the glazed surface of the tile, and ammonia can discolour the grout.
- 3) Film-forming cleaning agents should not be used as they can considerably reduce or even neutralise the slip resistance of ceramic coverings, and can also cause staining.
- 4) With high-pressure cleaners there is a slight danger of washing out and destroying cement joints if the machine is not used correctly (pressure too high because water jet is too close to surface). Using of unsuitable cleaning agents, e.g. acidic cleansers for cleaning increases this effect.
- 5) Where underfloor heating systems are installed, it is particularly important to ensure that the removed dirt and dirty water is cleaned before it is able to dry again when heating is on.

3.1. Unglazed tiles

VitrA unglazed tiles has a protective glaze finish that is not a glaze, but rather a special surface preparation sprayed on the tile before firing. During the manufacturing process, the structure of the tile surface is sealed with a protective glaze in order to further increase the tiles' resistance to staining and dirt, as a result of which subsequent treatment with impregnating agents is no longer necessary. The following represents a simple procedure for maintaining protective glaze coating and unpolished matte finish tile floors with a moderate soil load. For best results:

1. Sweep or vacuum the floor of all loose dirt and other foreign materials.
2. Saturate the floor with a mild cleaning solution and hot water, agitate, and allow it to dwell (remain on the floor) 5-10 minutes. Do not allow cleaning solutions to dry. It may be best to complete small areas at a time.
3. Clean routinely with tile cleaners that have a neutral pH for safe regular use.
4. Remove the dirty cleaning solution and rinse the surface with clean, clear water.
5. Buff with a dry mop or towel.

3.2. Glazed tiles

Wall tiles should be cleaned routinely with an all-purpose, non-oil-based household or commercial cleaner. The type of product may vary depending on the tile application and use. A multipurpose spray cleaner, which removes soap residue, hard water deposits and dirt designed for everyday use can be used on Wall tiles. Floor tiles should be cleaned and scrubbed with cleaner solution through the use of a cotton mop, cloth, sponge, or non-metallic brush.

Important Notice: Strongly alkaline or strongly acidic cleaning agents can attack or destroy the surface of glazed tiles and joints and must therefore not be used!

3.3. Polished porcelain

VitrA Protect is applied to the surfaces of the polished Porcelain tiles at the factory, improving the resistance to staining and soiling. VitrA does not recommend subsequent treatment with impregnating agents.

Important Notice: Dry thoroughly with a soft cloth after cleaning is completed to increase the shine and prevent water spots.

3.4. VitrA clean surface

The VitrA Clean finish was developed to achieve an easy-care tile surface by VitrA Innovation Center.

Dirt particles are virtually unable to hold and flow off with the water droplets on Wall tiles with VitrA Clean application. Water and a soft cloth are sufficient for routine cleaning without a need for aggressive detergents.

3.5. Antislip tiles

VitrA product range includes a great number of anti-slip glazed and unglazed series. These products are perfectly suitable for use in commercial, industrial and public areas as well as in wet barefoot areas such as swimming pools, showers and saunas. They have smooth, micro-rough or relief-type surfaces, depending on the area of application. In the case of anti-slip surfaces, mechanical cleaning by means of brushing machines with rotating soft nylon brushes or microfiber as well as high-pressure or vapour pressure cleaners is most effective, whereby joints must be cared during cleaning process. Cleaning agents, equipment and methods must be selected due to type of soiling and area of application. An extensive cleaning is required compared to smooth, glazed surfaces.

VitrA temizlik ve bakım talimatları

3.0.1. Düzenli temizlik için uyarılar:

- 1) Seramik karolara dair verilen temizlik, bakım ve lekelerin çıkarılması ile ilgili tüm bilgilerde, en son öğrenilmiş olan bilgi ve malzemeler temel alınmaktadır. Bu nedenle, genel bir bilgidir ve her bir olasılığı kapsamamaktadır. Temizlik maddesi ve derz imalatçısı tarafından sağlanan talimatlara dikkat edilmelidir.
- 2) Rutin temizleyiciler asla asit veya amonyak içermemelidir. Asitler karonun Sırlı yüzeyine ve derze zarar verebilir; amonyak, derzin rengini bozabilir.
- 3) Film oluşturu temizlik maddeleri, seramik kaplamaların kayma dayanımını önemli ölçüde azaltabilen, hatta yok edebilecekleri ve lekelenmeye neden olabileceği için kullanılmamalıdır.
- 4) Yüksek basınçlı temizleyicilerde, makine doğru kullanılmadığında (su jeti yüzeye çok yakın olduğu için basınç çok yüksekse) çimento derzlerini su ile çıkarılması ve zarar görmesi gibi bir tehlike söz konusudur. Uygun olmayan temizlik maddelerinin kullanılması, örneğin temizlik için asidik temizleyiciler bu etkiyi artırır.
- 5) Yerden ısıtma sistemlerinin olduğu yerlerde, ısıtma açıkken kir ve kirli suyun kurumadan temizlenmesi özellikle önemlidir.

3.1. Sırsız karolar

VitrA sırsız karolar, koruyucu bir sırla kaplıdır, bu kaplama pişirmeden önce sırdan farklı olarak karo üzerine püskürtülen özel bir yüzey hazırlık uygulamasıdır. Üretim işlemi sırasında, karo yüzeyinin yapısı, karonun lekelenmeye ve kirlenmeye karşı direncini daha da arttırmak için koruyucu bir malzeme ile kaplanır ve bunun sonucunda, emprenye maddesi ile ikincil işlemlere gerek kalmaz. Aşağıda bulunan temel temizlik prosedürü, koruyucu sırlı ve sırsız mat karolar için orta seviyedeki kirlenmelerde uygulanır. En iyi sonuçlar için aşağıdaki uygulamalara göre temizlik yapılması önerilir:

- 1) Tüm hafif tozlar, kirlere ve diğer yabancı maddeler süpürülmeli veya vakumlanmalıdır.
- 2) Zemin yumuşak bir temizleme solüsyonu ve sıcak su ile doyurulmalı, iyice karıştırılmalı/dağıtılmalı ve 5-10 dakika bekletilmelidir (yüzeyde kalması sağlanmalı). Temizleme solüsyonlarının kurummasına izin verilmemelidir. Tek seferde küçük alanları tamamlayarak ilerlemek en iyisidir.
- 3) Düzenli kullanımda nötr pH değerine sahip karo temizleyicilerle rutin olarak temizlenmelidir.
- 4) Kirli temizleme solüsyonu yüzeyden temizlenmeli, berrak su ile durulanmalıdır.
- 5) Kuru bir paspas veya havlu ile son işlem olarak yüzey kurulanmalıdır.

3.2. Sırlı karolar

Duvar karoları, çok amaçlı, yağ bazlı olmayan temizlik kimyasalı ile rutin olarak temizlenmelidir. Temizleyici tipi, karo uygulamasına ve kullanımına bağlı olarak değişebilir. Duvar karolarında, sabun kalıntılarını, sert su birikintilerini ve günlük kullanımda oluşan kirlere temizleyen çok amaçlı bir sprey temizleyici kullanılabilir. Yer karoları, pamuklu paspas, bez, sünger veya metalik olmayan fırça kullanılarak bir temizlik solüsyonu yardımı ile temizlenmelidir.

Önemli Uyarı: Kuvvetli alkali veya kuvvetli asidik temizlik maddeleri, Sırlı karoların yüzeyine ve derzlere zarar verip tahrip edebilir, bu nedenle bu tür temizlik maddeleri kullanılmamalıdır!

3.3. Parlatılmış porselen karolar

VitrA Protect, parlatılmış Porselen karoların yüzeyine fabrikada üretim esnasında uygulanır, karolardaki leke ve kirlenmeye karşı direnci artırır.

VitrA, emprenye kimyasalları/maddeleriyle yapılan ikincil işlemleri önermez.

Önemli Uyarı: Parlaklığı arttırmak ve su lekelerini önlemek için temizlik tamamlandıktan sonra yumuşak bir bezle iyice kurulayın.

3.4. VitrA Clean uygulanmış karolar

VitrA Clean, VitrA İnovasyon Merkezi tarafından kolay bakım yapılabilen bir yüzey elde etmek için geliştirilmiştir. Kir parçacıkları, VitrA Clean uygulaması ile Duvar karoları üzerinde tutunamaz ve su damlacıkları ile akar. Su ve yumuşak bir bez yardımı ile yoğun deterjanlara ihtiyaç duymadan rutin temizlik yapılabilir.

3.5. Kayma direnci olan karolar

VitrA ürün yelpazesinde çok sayıda kaydırmaz özellikli Sırlı ve sırsız ürün bulunmaktadır. Bu ürünler ticari, endüstriyel, kamusal alanlarda ve yüzme havuzları, duşlar, saunalar gibi ıslak alanlarda kullanım için uygundur. Uygulama alanına bağlı olarak pürüzsüz, mikro-pürüzlü veya rölyef tipi yüzeylere sahiptirler. Kaydırmaz yüzeylerde, dönen yumuşak naylon veya mikrofiber fırçalı yüzey temizleme makinelerinin yanı sıra yüksek veya buhar basınçlı temizleyiciler ile mekanik temizlik en etkili yöntemdir. Bu sayede temizlik işlemi sırasında derzlere zarar verilmemektedir. Kirlenme ve uygulama alanlarına göre temizlik maddeleri, ekipman ve yöntemler belirlenmelidir. Pürüzsüz, Sırlı yüzeylere kıyasla kapsamlı bir temizlik gereklidir.

VitrA cleaning and care instructions

A selection of suitable cleaning agents is outlined in the RK List (list of tested cleaning agents for ceramic surfaces in swimming pools) supplied by the German Society for the Pool Industry. In any case, the instructions for use and hazard warnings provided by the respective manufacturer must be respected.

There are several recommended good ways of cleaning this type of floor surface:

- High-pressure cleaning equipment (Pressure washers or high-pressure hoses).
- Vapour steam cleaners.
- Disc cleaners
- Scrubbing the surface with a brush with hard plastic bristles and then rinsing it with plenty of clean water.

3.5.1. Warnings for antislip tiles cleaning:

- 1) Brushes or pads containing abrasives must not be used under any circumstances, as they reduce slip resistance.
- 2) When using disc machines, suitable pads must be used, particularly on slip-resistant tile coverings in order to prevent cleaning from impairing the slip resistance. The slip-resistant properties are achieved through the roughness of the tile's surface or by means of relief-type profiling.
- 3) Whichever cleaning system is used, it is important to use clean water because otherwise, when the water evaporates, small particles of dirt from the water will be deposited in lower, more inaccessible parts of the embossed surface. For good results, it is essential to rinse with plenty of water.
- 4) Cleaning agent may cause the floor to become slipperier, therefore they should be rinsed thoroughly to avoid forming a greasy layer which negatively affects anti-slip safety. When anti-slip Floor tiles are cleaned, whatever their surface finish, it is not sufficient to clean them with damp mopping, because it will not clean away any dirt embedded in the particles that give the tiles their anti-slip finish. This means that dirt will build up, spoiling the overall appearance of the floor surface and normally modifying the colour slightly.
- 5) Alkaline cleaning agents should be used for basic cleaning and regular maintenance cleaning. Where water is soft, only occasional acidic cleaning is necessary (weekly or monthly depending on the flow of water and water hardness). Hard water requires more frequent use of cleaning agents.

3.6. Metallic tiles/decors

Some tiles are made out of metal-containing decoration which gives a shiny appearance with a silver / platinum / gold / copper effect. These tiles are indicated in the catalogue. For these tiles, extreme care must be taken during their installation, first cleaning after installation and general cleaning. Avoid using abrasive cleaners that can scratch and damage the surface. VitrA recommends using a soft cloth with water and alcohol. After cleaning, dry the surface with a clean cotton cloth to avoid water mark.

Important Notice: Never install metallic tiles/decors in wet areas such as showers, baths.

3.7. Photocatalytic tiles

The same products can be used for cleaning as for similar tiles without photocatalytic coating - with the advantage that the concentration of the cleaning agent can be considerably lower.

Any cleaning material forming a film or a greasy or sticky layer on the tile would impair the effectiveness of photocatalytic and must be avoided as they impede the incidence of light onto the tile surface.

It is very important to thoroughly remove cleaning and disinfecting agents.

* You can find most recent information about our products, Warranty Conditions, Cleaning and Care Instructions, along with other Product Performance Data and Installation specifications at:
www.vitra.com.tr / <https://vitraglobal.com/>

VitrA temizlik ve bakım talimatları

Havuz Endüstrisi için Alman Topluluğu tarafından sağlanan RK Listesinde (yüzme havuzlarındaki seramik yüzeyler için test edilmiş temizlik maddelerinin listesi) uygun temizlik maddelerinin seçimi anlatılmıştır. İlgili üretici tarafından verilen kullanım ve tehlike uyarılarına uyulmalıdır. Bu tür zemin yüzeyini temizlemek için önerilen birkaç yol vardır:

- Yüksek basınçlı temizlik ekipmanları (Basınçlı yıkayıcılar veya yüksek basınçlı hortumlar).
- Buharlı temizleyiciler
- Diskli yer temizleyiciler
- Yüzeyi aşındırıcı olmayan sert plastik bir fırça ile ovalamak (kayma direncine zarar vermeden) ve bolca temiz su ile durulamak

3.5.1. Kaydırmaz özellikli karoların temizliği için uyarılar:

- 1) Aşındırıcı özellikli fırçalar, pedler veya bezler, kayma direncini azalttığı için hiçbir koşulda kullanılmamalıdır.
- 2) Yer temizleme/cilalama makineleri, kayma dayanım özelliğini azaltmaması için kaymaya karşı dayanıklı karolara uygun olarak kullanılmalıdır. Kayma dayanım özelliği, karo yüzeyinin pürüzlülüğü veya rölyef ile elde edilir.
- 3) Tüm temizliklerde, temiz su kullanılması önemlidir. Aksi takdirde su buharlaştığı zaman, sudaki küçük kir parçacıkları yüzeyin daha az erişilebilen kısımlarına ulaşacak ve orada kirler kalacaktır. İyi sonuçlar elde etmek için yüzeyin bol su ile durulanması gerekir.
- 4) Temizleme maddesi zeminin kayganlaşmasına neden olabilir. Bu nedenle, kaymaya sebep olan ve kayma direncini olumsuz yönde etkileyen yağlı bir tabakanın oluşmasını önlemek için yüzeydeki temizlik maddesi iyice durulanmalıdır. Kaydırmaz özellikli yer karoları temizlendiğinde, yüzeyleri nasıl olursa olsun, bunları nemli paspas ile temizlemek yeterli değildir, çünkü karolarda kayma direncini sağlayan parçacıklara gömülmüş kirleri temizlemeyecektir. Bu da kirlerin birikerek yüzeyinin genel görünümünü bozmasına ve rengin biraz değişmesine neden olacaktır.
- 5) Temel ve düzenli bakımda alkali temizlik malzemeleri kullanılmalıdır. Eğer temizlik için kullanılan su yumuşaksa, daha az sıklıkta (su ve suyun sertliğine bağlı olarak haftalık veya aylık) yüzeye zarar vermeyen asidik temizlik malzemeleri kullanmak gerekir. Sert su, daha fazla temizlik kimyasalına ihtiyaç duymaya neden olur.

3.6. Metalik karolar/dekorlar

Bazı karolar üzerinde gümüş / platin / altın / bakır etkisi ile parlak bir görünüm veren metal dekorlar bulunmaktadır. Bu karolar kataloglarda belirtilmiştir ve döşeme sırasında, döşeme sonrası ilk temizlikte ve genel temizliklerde çok dikkatli ve özenli olunmalıdır. Yüzeyi çizebilecek ve zarar verebilecek aşındırıcı temizleyiciler kullanılmamalıdır. VitrA, su ve alkol ile yumuşak bir bez kullanmanızı önerir. Temizledikten sonra, su lekelerini önlemek için yüzey temiz bir pamuklu bezle kurulanmalıdır.

Önemli Uyarı: Metalik karolar / dekorlar asla duş, banyo gibi ıslak mekanlarda kullanılmamalıdır.

3.7. Fotokatalitik karolar

Temizlik için, fotokatalitik kaplama içermeyen diğer karolarda kullanılan ürünler kullanılabilir - daha düşük konstrasyona sahip temizlik maddeleri de yeterli olabilmektedir. Karo üzerinde bir film, yağlı ya da yapışkan bir tabaka oluşturan herhangi bir temizlik malzemesi, fotokatalitik etkiyi bozar ve bu tür tabaka oluşturan malzemeler karo yüzeyinin ışık almasını engeller. Bahsi geçen uygulamalar, bu tür karoların özelliklerini azaltacağından yapılmamalıdır. Temizlik için kullanılan malzemeleri iyice durulamak ve yüzeyden arındırmak çok önemlidir.

*Ürünler için teknik bilgiler, döşeme talimatları, garanti koşulları, temizlik ve bakım talimatlarıyla ilgili güncel bilgiler VitrA web sitesinde yer almaktadır:

www.vitra.com.tr / <https://vitraglobal.com/>

UPEC

UPEC classification associated with the QB certification mark attests to the compliance of floor coverings with the technical requirements set out in certification reference documents. Although it is not compulsory to have an item classified according to UPEC standards, this classification means giving a customer the opportunity to choose an appropriate product for the intended use.

The UPEC classification is performed by the CSTB (Centre Scientifique et Technique du Bâtiment, Scientific and Technical Building Centre) in Paris.

The four letters U, P, E and C stand for:

U: It indicates the wear resistance and corresponds to the wear groups as per EN ISO 10545-7. The index U can go from 2 (minimum stress) to 4.

P: It indicates the mechanical stresses to which the floor is expected to be subjected. These stresses can be caused by mobile or fixed furnishing uses or objects falling on the floor. It is also defined using the bending (tensile) strength. In practice the five indices 2, 3, 4, 4+ and 4s (highest toughness) are assigned.

E: It indicates the water sensitivity of the floor covering. This index E can go from 1 to a maximum of 3. The highest index 3 is always assigned to ceramic tiles. It is however remembered that the classification E3 of the tiles does not imply that a tiled floor is waterproof.

C: It indicates the resistance to chemical and staining substances that have a negative effect on the durability of the covering (stains, attacks that penetrate to various depths etc.). The index C can go from a minimum of 0 (lowest risk) to 2 (exceptionally 3 for particular rooms, as some laboratories).

Only certified manufacturers have the right to stipulate the UPEC classification of tested tiles. These tiles display the QB-UPEC logo on the labels and the UPEC classification of the product is indicated as well.

This certification guarantees:

- that the tiles comply with the prerequisites of the EN 14411 standard,
- that the tiles actually possess the specified wear-resistance characteristics, as defined by the UPEC classification (regular checking by an independent laboratory)
- that the tiles originate from a constantly controlled manufacturing process according to the extremely strict rules and regulations.

This is provided for information purposes only. CSTB has the right to replace/revise this Technical information and the UPEC classification of the products.

The full, up-to-date list of certified products of Vitra can be viewed at the following address:

<http://evaluation.cstb.fr/fr/carreau-ceramique/detail/1909/>

<http://webapp.cstb.fr/upec-ceramique/index.php?view=TitulaireGammeSerie&sid=32>



UPEC

QB sertifikalandırma işareti ile ilgili UPEC sınıflandırması referans belgelerinde belirtilen teknik gerekliliklerle zemin kaplamalarının uygunluğunu teyit eder. UPEC standartlarına göre sınıflandırılan bir ürüne sahip olmak zorunlu olmasa da, bu sınıflandırma müşteriye kullanım amacına uygun ürünün seçilme imkanını vermektedir.

UPEC sınıflandırması Paris'teki CSTB (Centre Scientifique et Technique du Bâtiment, Bilimsel ve Teknik Yapım Merkezi) tarafından gerçekleştirilmektedir.

Dört harf U, P, E ve C aşağıdakileri ifade etmektedir:

U: Aşınma dayanımını göstermektedir ve EN ISO 10545-7'ye göre aşınma gruplarına karşılık gelmektedir. U sınıflandırması 2 (minimum stres) ile 4 arasında olabilmektedir.

P: Zeminin maruz kalması beklenen mekanik stresleri ifade etmektedir. Bu stresler hareketli veya sabit döşeme kullanımları veya zemine düşen nesnelere nedeniyle oluşabilmektedir. Bu ayrıca eğilme (gerilme) direnci kullanılarak da tanımlanmaktadır. Uygulamada beş sınıflandırma; 2, 3, 4, 4+ ve 4s (En yüksek sertlik) kullanılmaktadır.

E: Zemin kaplamasının su duyarlılığını göstermektedir. Bu E sınıflandırması 1 ile 3 arasında olabilmektedir. En yüksek sınıf olan 3 seramik karolar için tanımlanmıştır. Karoların E3 sınıflandırmasının karo döşenmiş bir zeminin su geçirmez olduğu anlamına gelmediği hatırlanmalıdır.

C: Bu kaplamanın dayanıklılığı üzerinde olumsuz etkisi olan kimyasal ve lekelenme maddelerine karşı dayanıklılığını tanımlamaktadır (Farklı derinliklere nüfus eden lekeler). C Endeksi minimum 0 seviyesinden (en düşük risk) 2 düzeyine çıkabilmektedir (Bazı laboratuvar gibi belirli odalar için istisnai olarak sınıf 3 olarak verilebilir).

Sadece onaylı üreticiler test edilen karoların UPEC sınıflandırmasını belirleme hakkına sahiptirler. Bu karolar için etiket üzerinde QB-UPEC logosu ve ürünün UPEC sınıflandırması gösterilir.

Bu sertifikalandırma şunları garanti etmektedir:

- Karoların EN 14411 standardının ön şartlarını karşıladığını,
- Karoların UPEC sınıflandırmasında tanımlanan belirli aşınma dayanım özelliklerine sahip olduğunu (Bağımsız bir laboratuvar tarafından düzenli kontrol yapılarak)
- Karoların aşırı katı olan kural ve yönetmeliklere göre düzenli kontrol edilen bir üretim sürecinden geçerek üretildiğini.

Bunlar sadece bilgi amaçlı olarak verilmiştir. CSTB, bu teknik bilgileri ve ürünlerin UPEC sınıflandırmasını yenileme/güncelleme hakkına sahiptir.

VitrA sertifikalı ürünlerinin tam ve güncel listesi aşağıdaki adresten görüntülenebilmektedir:

<http://evaluation.cstb.fr/fr/carreau-ceramique/detail/1909/>

<http://webapp.cstb.fr/upec-ceramique/index.php?view=TitulaireGammeSerie&sid=32>



Certificates

Management system certificates



ISO 9001:2015



ISO 14001:2015



OHSAS 18001:2007



ISO 50001:2015



ISO/IEC 27001:2013



TSE Covid 19 Safe Production Certificate

Product certificates



EU Ecolabel Certificate*



Greenguard Gold Certificate



International EPD® System Certificate*



Saudi Arabia Export Certificate*



QB UPEC Certificate*



Domestic Production Certificate

Turkish Standard Institute Certificates



Turkish Standards Institute Certificate of Conformity to Double Star Criteria



Turkish Standards Institute Certificate of Conformity to Turkish Standards

*For specific products/series only.
Please refer to the website for the up-to-date certificates:
<https://vitraglobal.com/catalogues/quality-certificates>
<https://www.vitra.com.tr/kalite-sertifikalari/vitra-karo/>

Sertifikalar

Yönetim sistemleri sertifikaları



ISO 9001:2015



ISO 14001:2015



OHSAS 18001:2007



ISO 50001:2015



ISO/IEC 27001:2013



TSE Covid 19 Güvenli Üretim Sertifikası

Ürün sertifikaları



EU Ecolabel Sertifikası*



Greenguard Gold Sertifikası



International EPD® System Sertifikası*



Saudi Arabia Export Sertifikası*



QB UPEC Sertifikası*



Yerli Üretim Sertifikası

Türk Standartları Enstitüsü Sertifikaları



Türk Standartları Enstitüsü Çift Yıldız
Kriterine Uygunluk Sertifikası



Türk Standartları Enstitüsü
Türk Standartlarına Uygunluk Belgesi

*Sadece belirli ürünlerde/serilerde geçerlidir.
Güncel sertifikalar için lütfen aşağıdaki web-sitelerine başvurun:
<https://vitraglobal.com/catalogues/quality-certificates>
<https://www.vitra.com.tr/kalite-sertifikalari/vitra-karo/>

VitrA terms and warranty conditions

1. Product quality

1.1. Products designated as “Quality: 1” comply with the quality requirements of European quality standard EN 14411. Those designated other than “Quality: 1” comply with the requirements for the CE-symbol but not with the aforementioned standard and exhibit technical and/or visual defects excluding them from classification as “Quality: 1” products.

1.2. No liability can be assumed if the colour, surface appearance of the goods delivered is not even or if the goods do not exactly match the samples or merchandising, the images on the website or the printed material (i.e. catalogues, brochures, price lists etc.). This is due to the variability of the natural raw materials and the ceramic production process.

Particularly in mosaics, some colour variation is to be expected which is limited to the quality requirements of European quality standard EN 14411.

1.3. Tiles may vary in colour, texture or appearance according to product design for particular tile collections. Especially Shade variation V3, V4 type products may vary significantly within boxes, samples, merchandising and display. It is strongly recommended to pay attention to Shade variation during product selection.

1.4. Normal tolerances with respect to size and thickness do not constitute flaws. This shall also apply to any subsequent deliveries.

1.5. All floor coverings are subject to wear and tear depending on the area of application, the frequency of contact, the type and degree of soiling as well as the hardness and wear resistance of the product in question. The classification in stress groups refers to the wear resistance of the glazed surface, but not to the resistance to strain caused by pressure or heavy weights.

1.6. In the case of some artistic and decorative glazes, crazing in the glaze (formed before/after laying) is a natural effect and do not impair the ability to use the tiles for their intended purpose or constitute a defect.

1.7. During product selection, please pay attention to recommendations for area of use for suitable products in the price lists or catalogues.

2. Complaint management

2.1. The delivered goods shall be inspected immediately upon receipt to ensure that they are correct, complete and free of any defects. If there is an external/visible damage on the pallets identified during unloading of the delivery, the customer must remove the packaging for the pallets in question and inspect the goods. Any complaints shall be referred to VitrA in writing without delay and at the latest within 14 days.

Any defects that do not become obvious until after the boxes have been opened shall also be reported in writing within 14 days and, in any case, prior to being laid. In any case, they may not be laid. In the absence of any written complaint or if the goods are laid, they are assumed to be accepted by the customer and the products are free of any defects.

2.2. Defected products must be kept ready and available for inspection at the time of realising the defects, without any removal of the tiles. Pallet and box labels should be stored as reference for analysing the defects thoroughly. All further processing of such goods must be stopped. The customer shall duly store the defected products until the complaint has been settled. In the event of a violation of the above obligation, VitrA does not carry an obligation to provide any replacements or any kind of payment.

2.3. If the complaint includes tiles that are already laid, VitrA carries an obligation only for those defects that become evident only after the tiles that are properly used according to the maintenance and care instructions. The tiles can be removed only after VitrA has been given the opportunity to inspect the defect within a reasonable time period and VitrA has given consent for removal in writing.

2.4. In any case, the removal of the tiles laid is limited to the defected tiles only.

2.5. VitrA reserves the right to repair, refund or replace the purchased or an equivalent product (to the same value) at its sole discretion.

2.6. No claim will be accepted without product inspection by VitrA or its authorized representatives.

2.7. The customer must notify VitrA, authorized representative or seller in writing within 14 days of the discovery of any defects. Claims can be notified via website:

www.vitra.com.tr / <https://vitraglobal.com/contact>

3. Warranty conditions

3.1. Information contained on website or in brochures, offers, product descriptions, drawings, illustrations, Certificate of Conformities or other declarations, e.g. with respect to dimensions, weights or other performance criteria, may not be a binding guarantee but shall merely be deemed to be general product warranty information.

3.2. Warranty shall be assertible solely in case of fault on our part regarding material, workmanship and production under proper use resulting noncompliance of the product to VitrA specifications, industry allowable tolerances and quality standard such as EN 14411 and ANSI 137.1. Where warranty claims are assertible against our representatives, such parties shall be liable to the customer solely in case of fault on our part regarding material, workmanship and production under proper use resulting noncompliance of the product to VitrA specifications, industry allowable tolerances and quality standard such as EN 14411 and ANSI 137.1. If this is the case and if the conditions specified in Section 2 are satisfied, VitrA may choose to repair, replace with non-defected same or equivalent products or compensate the customer for the reduced value of the products caused by the defects in question, depending on the nature of the defect and availability of the product. In each case, no further remedies shall be available to the customer other than VitrA's. Purely optical defects (i.e. matt/gloss differences, colour shade differences, digital printing faults and thin printing stripes etc.) shall only entitle the customer to claim a reduction in value. There would not be any change for the laid products.

3.3. Any usage errors or misuse of the product by the customer including physical or chemical abuse, or negligence is evaluated as direct damages/user error and they are not covered under the product warranty.

3.4. Do not apply any adhesive material to the laid/not laid tiles, decorative or skirting tiles. Any direct damage that may occur as a result of this application is considered as a user error and VitrA is not liable for any product change or payment.

3.5. We shall solely reimburse direct damages stated above provided that such direct damages are finally awarded by a court of competent jurisdiction.

3.6. The customer is obliged to inform VitrA within 14 calendar days in writing about the products / pallets which have delivered as broken, and to keep all broken products for inspection by the technical experts authorized by VitrA. VitrA is not responsible for any changes or claims for damages if it determined by technical experts that the fracture formation is not caused by the pallet arrangement.

VitrA garanti koşul ve kuralları

1. Ürün kalitesi

- 1.1. "Kalite: 1" olarak tanımlanan ürünler, Avrupa Kalite Standardı EN 14411'in gerekliliklerini sağlamaktadır. "Kalite: 1" dışında tanımlanan ürünler ise CE-sembolünün gerekliliklerini sağlar, ancak EN 14411 standardının, CE işareti gereklilikleri haricindeki görsel veya teknik 1. Kalite gerekliliklerini sağlamayabilir.
- 1.2. Teslim edilen ürünlerin renk, yüzey görünüşünün benzer olmaması ya da ürünlerin numunelerle, mağaza teşhirleriyle, web sitesindeki görüntüler veya basılı evraklar ile tam olarak uymaması durumunda hiçbir sorumluluk kabul edilmez (Örneğin Kataloglar, broşürler, fiyat listeleri vb.). Bu durum üretimde kullanılan doğal hammaddelerin değişkenliğinden ve seramik üretim prosesinden kaynaklanmaktadır. Özellikle mozaiklerde, Avrupa Kalite Standardı EN 14411'in kalite gereklilikleriyle sınırlı olacak oranda hafif renk değişimleri beklenmektedir.
- 1.3. Karolar, bazı serilerdeki ürün tasarımı kaynaklı olarak, renk, doku ve görünüş olarak değişiklik gösterebilir. Özellikle Desen farklılaşması V3, V4 olarak tanımlanan ürünler kutu içindekilerle, numunelerle, ticari numunelerle ve teşhirlerle önemli ölçüde farklılık gösterebilir. Ürün seçimi sırasında Desen farklılaşmasına dikkat etmenizi önemle bilgilerinize sunarız.
- 1.4. Boyut ve kalınlığı bakımından ISO 13006, EN 14411 ve ANSI 137.1 standartlarında belirtilen toleranslar içerisinde olan ürünler kusur teşkil etmez. Bu durum, farklı sevkiyatlarda gönderilen ürünlerin her teslimatı için geçerlidir.
- 1.5. Tüm zemin kaplamaları, uygulama alanına, kullanım yoğunluğuna, kirleticinin türüne ve kirlenmenin yoğunluğuna, ayrıca söz konusu ürünün sertliğine ve aşınma direncine bağlı olarak aşınma ve yıpranmaya maruz kalır. Stres gruplarındaki sınıflandırma, Sırlı yüzeyin aşınma direncine karşılık gelir, ancak basınç veya ağır yüklerin neden olduğu gerilime/sürtünmeye karşılık direncini göstermez.
- 1.6. Dekoratif sırlar söz konusu olduğunda, sırt içindeki çatlaklar (döşmeden önce / sonra oluşan) doğal bir etkidir ve karoların amacına yönelik kullanımına olumsuz bir etkisi olmaz veya bir hata teşkil etmez.
- 1.7. Ürün seçimi sırasında, fiyat listeleri veya kataloglarda bulunan kullanım alanı önerilerine dikkat edilmelidir.

2. Şikayet yönetimi

- 2.1. Teslim edilen ürünlerin, doğru, eksiksiz ve herhangi bir kusur taşımadıklarından emin olmak için teslim alındıktan sonra derhal kontrol edilmelidir. Teslimatın indirilmesi sırasında belirlenen paletler üzerinde harici / görünür bir hasar varsa, söz konusu paletlerin ambalajları açılmalı ve ürünler gözden geçirilmelidir. Tüm şikayetler VitrA'ya gecikme olmaksızın en geç 14 gün içinde yazılı olarak bildirilmelidir. Kutular açılmadan anlaşılabilen tüm hatalar da en geç 14 gün içerisinde, karolar döşenmeden önce VitrA'ya yazılı olarak bildirilmelidir. Hata olduğu düşünülür veya görülürse ürünler döşenmemelidir. Yazılı şikâyetin bulunmadığı veya ürünlerin döşendiği durumlarda, ürünlerin müşteri tarafından kabul edildiği varsayılır ve ürünler kusursuz kabul edilir.
- 2.2. Kusurlu ürünler, hata fark edildiğinde sökülmemeli ve kontrol için hazır halde bulundurulmalıdır. Kutu, palet ve kutu etiketleri, şikâyetin incelenmesi için saklanmalıdır. Ürünlerin hataları fark edildiğinde döşeme işlemleri durdurulmalı, şikâyet çözülene kadar kusurlu ürünler saklanmalıdır. Yukarıdaki şartların ihlali durumunda VitrA herhangi bir ürün değişimi veya herhangi bir ödeme yapma yükümlülüğü taşımamaktadır.
- 2.3. Şikâyet, halihazırda döşenmiş karolar içinse, VitrA, yalnızca temizlik ve bakım talimatlarına göre uygun şekilde kullanılan karolarda ortaya çıkan kusurlar için bir yükümlülük taşır. Karolar, VitrA'ya makul bir süre içinde kusuru inceleme fırsatı verildikten ve VitrA yazılı olarak izin verdikten sonra sökülebilir, aksi takdirde işlem yapılamaz.
- 2.4. VitrA tarafından üretim hatası olarak kabul edilen şikâyetlerde yapılacak değişim sadece hatalı karoların değiştirilmesi ile sınırlıdır.
- 2.5. VitrA, satın alınan üründe hata çıkması durumunda birebir değiştirme, tamir etme, iade alma veya muadili ile değiştirme hakkını saklı tutar.
- 2.6. VitrA veya yetkili temsilcileri tarafından ürün incelemesi yapılmadan hiçbir talep ve şikâyet kabul edilmeyecektir.
- 2.7. Müşteri, herhangi bir kusurun bulunmasından sonraki 14 gün içerisinde VitrA'yı, yetkili temsilci veya satıcıyı yazılı olarak bilgilendirmelidir. Talepler web sitesi aracılığıyla da bildirilebilir:
www.vitra.com.tr/iletisim / <https://vitraglobal.com/contact>

3. Garanti koşulları

- 3.1. Web sitesinde, broşürlerde, tekliflerde, ürün açıklamalarında, çizimlerde, numunelerde, Uygunluk Sertifikasında veya diğer beyanlarda bulunan bilgiler, (Örneğin boyutlar, ağırlıklar veya diğer performans kriterleri) bağlayıcı bir garanti değildir, sadece genel ürün bilgileri olarak kabul edilmelidir.
- 3.2. Garanti, ürünlerin müşteri tarafından doğru ve amacına uygun olarak kullanılması şartıyla, malzeme, işçilik ve üretim kaynaklı bir hata içeren durumlarda; VitrA'nın şartlarının, endüstride kabul edilen EN 14411 ve ANSI 137.1 gibi standartlardaki toleransların dışına çıktığı durumlarda geçerlidir. Bayiler/temsilciler, ürünlerin müşteri tarafından doğru ve amacına uygun olarak kullanılması şartıyla, malzeme, işçilik ve üretim kaynaklı bir hata içeren durumlarda; VitrA'nın şartlarının, endüstride kabul edilen EN 14411 ve ANSI 137.1 gibi standartlardaki toleransların dışına çıktığı durumlarda müşteriye karşı sorumlu olacaktır. Bölüm 2'de belirtilen şartlar yerine getirilmişse, VitrA, müşterinin hatalı ürünlerden oluşan zararını karşılamak için, mevcut stoklara ve hata tipine bağlı olarak, onarım yapma, hatalı ürünü kusurlu olmayan birebir veya eşdeğer ürünlerle değiştirme hakkını saklı tutar. VitrA tarafından beyan edilen çözüm yönteminin dışında bir talep kabul edilmeyecektir. Tamamen görsel kusurlardan oluşan durumlarda (Örneğin matlık / parlaklık farklılıkları, renk tonu farklılıkları, dijital baskı hataları ve ince baskı çizgileri vb.), hatalı ürün adediyle sınırlı olmak şartıyla ürün satış bedeli üzerinden indirim talep etme hakkı verir, döşenen ürünlerde değişim yapılmaz.
- 3.3. Ürünün fiziksel veya kimyasal olarak hatalı kullanıma maruz kalması veya ihmalkarlık dahil olmak üzere müşteri tarafından herhangi bir şekilde yanlış kullanılması durumu kullanıcı hatası olarak değerlendirilir ve söz konusu ürün garanti kapsamında değerlendirilmez.
- 3.4. Döşenmiş/döşenmemiş karo, dekor veya süpürgelikler üzerinde herhangi bir yapıştırıcı madde içeren malzeme ile uygulama yapılmamalıdır. Bu uygulama neticesinde ortaya çıkabilecek direkt hasarlar kullanıcının hatası olarak kabul edilir ve VitrA herhangi bir ürün değişikliği veya ödeme yapma yükümlülüğü taşımamaktadır.
- 3.5. Yukarıda tanımlanan durumlarda, kararın nihai olarak taraflarca yetkili tayin edilen bir mahkeme tarafından verilmesi şartıyla sadece oluşan direkt hasar/zarar VitrA tarafından tazmin edilir.
- 3.6. Müşteri, eline kırık olarak ulaşan ürünler/paletler ile ilgili, 14 takvim günü içinde VitrA'yı yazılı olarak bilgilendirmek ve tüm kırık ürünleri VitrA tarafından yetkilendirilmiş teknik uzmanlarca incelenmesi için muhafaza etmekle yükümlüdür. Kırık oluşumunun palet dizilimi kaynaklı olmadığına teknik uzmanlarca tespiti halinde VitrA, herhangi değişim ve tazminat taleplerinden sorumlu değildir.

VitrA terms and warranty conditions

- 3.7. The customer is responsible to check the goods for any variation in colour before being laid. Once the goods have been laid, VitrA is not liable under any circumstances for variations in colour. The products which have the same colour tone and calibre number should be laid to the same space by mixing different boxes. The product should not be laid without joint due to technical reasons. The recommended joint width should be used that is indicated on the boxes.
- 3.8. Products (Wall tiles, Floor tiles, Porcelain, pool parts and mirrored tiles) should never be laid on the ceiling. VitrA is not liable for any incidents or consequences of accidents, property or loss of life that may occur as a result of laying.
- 3.9. VitrA strongly recommends ordering and storing for more than enough products from the area calculated (min. 2 boxes or 2% for areas larger than 100 square meters according to the area to be used) for the losses and the partial change and repair requirements that may occur during installation / use and keep them for future requirements.
- 3.10. Rectified / Non-rectified products with pattern should be controlled with recommended joint width during before laying. In the absence of any written complaint or if the goods are laid, they are assumed to be accepted by the customer and the products are free of any defects.
- 3.11. Installation quality is as important as product quality, therefore VitrA recommends utilization of competent tile layers for the best results. VitrA does not accept any responsibility for defects aroused from infrastructure failures, faults due to installation and insulation, errors caused by application of plaster without hardening enough, application of faulty plaster / defects due to plaster content, breakage / cracking due to improper application of adhesive under tiles, incorrect flooring and wrong adhesive selection.
- 3.12. In wide area applications (in areas larger than 6x6 m), the elasticity of the adhesive alone is not sufficient. The continuity of the coating should be cut using expansion joints and the tensile movements should be damped with the help of these joints. Attention should be paid to the structural expansion (dilatation) joints left on the application surfaces and the joints should not be covered with tile. Any direct damage that may occur as a result of non-observance of this application is considered as a user error and VitrA is not liable for any product change or payment.
- 3.13. VitrA shall not accept any warranty for metallic decors and metallic glazed tiles installed in wet areas such as showers, baths etc. Never use abrasive materials and strong cleaning agents for cleaning these products. Please refer to Maintenance and Cleaning Instructions.
- 3.14. Any food, liquid or chemical spill must be cleaned away immediately to prevent harsh staining. It is possible for foreign substances to leave slight discoloration on the tiles if left unattended for prolonged time periods. VitrA's warranty does not cover deterioration to the product due to improper use, incorrect cleaning applications or gross negligence.
- 3.15. VitrA is not liable for any of the consequences of improper planning, wrong product selection, and environmental conditions or for damage caused by inappropriate cleaning that is not carried according to the maintenance and care instructions. Under any circumstances, the detergents must not contain any hydrofluoric acid and its derivatives.
- If alternative/restorative floor treatments are employed, it is the responsibility of the floor treatment manufacturer/seller to verify compatibility and offer product warranty. Some treatments may alter the tile surface characteristics such as anti-slip resistance, staining resistance etc. which might be inconsistent with VitrA's product recommendations and VitrA's warranty does not cover this situation.
- 3.16. Inappropriate product selection may cause abrasion, breakage, crack, slipperiness, frost damage etc. on the tiles. VitrA is not liable for lawsuit, replacement or renovation claims regarding these kind of consequences of improper planning or misuse of the products.
- 3.17. VitrA is not responsible for any replacement or renewal request arising from laying procedures that are in contradiction with VitrA's written or visual laying guidelines specified on the box, product or catalogue.
- 3.18. VitrA shall not accept any warranty for products other than those classified as "Quality: 1".
- 3.19. In the event of any damage to the product during the cutting process, VitrA informs the customer about the conditions of cutting, which equipment can be used and cutting techniques. In the event of a dispute, VitrA's standard cutting test result and recommendation of VitrA are taken into consideration. VitrA is not responsible for any replacement or replacement requests caused by improper use of the products or applications other than the recommended cutting application.
- 3.20. VitrA shall assume no warranty for any additional secondary application with refiring or without refiring such as polishing, rectification, scoring, wet/dry cutting, netting without written approval.
- 3.21. The use of dark coloured grout is not recommended due to the color pigments in the chemical composition of the material. If used, it should be tested for staining performance on several tiles before grouting. For products with risk of staining, the tiles should be covered with a protective film, primer or similar material before the application and then grouting should be made.
- 3.22. If dark coloured (black anthracite, dark blue, etc.) grouting materials are used, stains caused by the chemical structure of the grout may occur, such stains are not covered by the guarantee.
- 3.23. For tiles to be used in dry areas, minimum C2 type adhesives must be used, and for tiles that are suitable for use in wet areas or pools, minimum C2TE S2 type adhesives must be used. Ceramic tile adhesives suitable for the needs of the relevant area should be used for special application areas (flexible, very flexible, fast setting, frost resistant etc.). For special adhesive types, information should be obtained from adhesive producers and application should be made according to their directions.
- 3.24. It is essential to completely fill the bottom of tiles with ceramic adhesive materials, using appropriate ceramic trowel and fixing technique, so that there is no gap left between the floor and the ceramic tile. The presence of any gap left under the tile directly affects the load bearing and impact resistance performance of tiles. If there is a gap under the tiles, the products are out of the scope of guarantee in terms of strength properties.

* You can find most recent information about our products, Warranty Conditions, Maintenance and Cleaning Instructions, along with other Product Performance Data and Installation specifications at:
www.vitra.com.tr / <https://vitraglobal.com/>

VitrA garanti koşul ve kuralları

- 3.7. Müşteri, döşeme yapılmadan önce herhangi bir desen/rengi farklılaşması olup olmadığına dair ürünleri kontrol etmekle yükümlüdür. Ürünler döşendikten sonra, VitrA, renk farklılaşması için hiçbir koşulda sorumlu değildir. Aynı renk tonuna ve kalibreye sahip ürünler, farklı kutuları karıştırarak aynı alana döşenmemelidir. Ürünler teknik sebeplerden dolayı derzsiz döşenmemelidir. Kutu üstünde tavsiye edilen derz ölçüsü kullanılmalıdır.
- 3.8. Ürünler (Duvar kerosu, Yer kerosu, porselen, havuz parçaları ve aynalı karolar) kesinlikle tavana döşenmemelidir. Döşenmesi halinde yaşanabilecek kaza, mal veya can kaybı olaylarının doğurabileceği talep ve sonuçlardan VitrA sorumlu değildir.
- 3.9. Döşeme esnasında oluşabilecek kayıplar ve döşeme/kullanım sonrası oluşabilecek kısmi değişim ve tamirat ihtiyaçları için hesaplanan alandan yeteri kadar fazla (kullanılacak alana göre min. 2 kutu veya 100 metrekareden büyük alanlar için %2) ürün sipariş etmenizi ve ileride oluşabilecek ihtiyaçlar için saklamanızı önemle tavsiye ederiz.
- 3.10. Rektifiyeli/kalibreli ürünler, döşeme öncesinde önerilen derz aralığı ile kontrol edilmelidir. Herhangi bir yazılı şikâyetin bulunmaması veya desen takibi bulunan özel ürünlerin tavsiye edilen derz artışı ile kontrol edildikten sonra döşenmesi halinde, ürünlerin müşteri tarafından kabul edildiği ve kusursuz olduğu varsayılır.
- 3.11. Döşeme kalitesi ürün kalitesi kadar önemlidir, bu nedenle VitrA, ürünlerinden en iyi performansın alınması için döşemenin yetkin karo döşeyicileri tarafından yapılmasını önerir. Altyapı hataları, tesisat ve yalıtım kaynaklı hatalar, uygulanan sıva yeterince sertleşmeden yapılan uygulama kaynaklı hatalar, hatalı sıva kullanımı/sıva muhteviyatı kaynaklı hatalar, karoların altında uygun şekilde yapıştırıcı uygulanmaması nedeniyle oluşan kırılma/çatlama, yanlış döşeme ve yanlış yapıştırıcı seçimi nedeniyle ortaya çıkan hatalar VitrA'nın sorumluluğunda değildir.
- 3.12. Geniş alan uygulamalarında (6x6 m'den büyük alanlarda) yapıştırıcının elastikiyet özelliği tek başına yeterli olmamaktadır. Kaplama sürekliliği genleşme derzleri kullanılarak kesilmeli ve bu derzler yardımıyla gerilme hareketleri sönümlenmelidir. Uygulama yüzeylerinde bırakılmış yapısal genleşme (dilatasyon) derzlerine dikkat edilmeli, derzlerin üzeri kesinlikle karo ile kaplanmamalıdır. Bu uygulamaya uyulmaması neticesinde ortaya çıkabilecek direkt hasarlar kullanıcı hatası olarak kabul edilir ve VitrA herhangi bir ürün değişikliği veya ödeme yapma yükümlülüğü taşımamaktadır.
- 3.13. VitrA, duş, banyo vb. ıslak alanlara döşenen metalik dekorlar ve metalik Sırlı karolar için herhangi bir garanti sunmamaktadır. Bu ürünleri temizlemek için kesinlikle aşındırıcı malzemeler ve güçlü temizlik maddeler kullanılmamalıdır. Detaylı bilgi için Temizlik ve Bakım Talimatlarına bakınız.
- 3.14. Karo üzerinde ağır lekelenmeleri önlemek için herhangi bir gıda, sıvı veya kimyasal dökülmesi durumunda karo yüzeyi derhal temizlenmelidir. Uzun süre temizlenmez ise, yabancı maddelerin karolarda hafif renk değişimi yapması mümkündür. VitrA'nın garantisi, yanlış kullanım, yanlış temizlik uygulamaları veya ihmal nedeniyle ürünün bozulmasını kapsamamaktadır.
- 3.15. VitrA, hatalı tasarım, yanlış ürün seçimi, çevre koşulları veya temizlik ve bakım talimatlarına uygun olmayan temizlikten kaynaklanan hasarlardan sorumlu değildir. Kullanılan deterjanlar kesinlikle hidroflorik asit ve türevlerini içermemelidir. Alternatif / koruyucu zemin uygulamaları kullanılıyorsa, uygulamayı doğrulamak ve ürün garantisini sunmak zemin uygulamaları üreticisinin / satıcısının sorumluluğundadır. VitrA'nın ürün önerilerinden bağımsız yapılan özel yüzey uygulamaları kaymazlık değeri, lekelenme direnci vb. gibi karo yüzey özelliklerini değiştirebilir ve bu durum VitrA'nın garanti şartlarını geçersiz kılar.
- 3.16. Uygun olmayan ürün seçimi, karolarda aşınmaya, kırılmaya, çatlamaya, kaymaya, donma hasarına vb. neden olabilir. VitrA, hatalı planlamanın veya ürünlerin yanlış kullanımının bu tür sonuçlarıyla ilgili dava, değiştirme veya yenileme taleplerinden sorumlu değildir.
- 3.17. VitrA'nın kutu, ürün veya katalog üzerinde belirttiği yazılı ya da görsel döşeme yönergelerine aykırı yapılmış döşeme işlemlerinden doğacak herhangi değiştirme veya yenileme talebinden VitrA sorumlu değildir.
- 3.18. VitrA, "Kalite: 1" olarak sınıflandırılanların dışındaki ürünler için herhangi bir garanti vermemektedir.
- 3.19. Kesme işlemi esnasında üründe meydana gelebilecek herhangi bir hasar durumunda VitrA, ürünlerin hangi ekipman kullanılarak ve hangi koşullar altında, hangi teknikte kesilebildiğini müşteriye bildirir. Anlaşmazlık halinde VitrA'nın standart kesme test sonucu ve önerisi esas alınır. VitrA, ürünlerin yanlış kullanımı veya önerilen kesme uygulaması dışındaki uygulamalar nedeniyle oluşan değiştirme veya yenileme taleplerinden sorumlu değildir.
- 3.20. VitrA, yazılı izni olmaksızın ürünlerinde fırınlanarak veya fırınlanmadan yapılan ikincil işlemlere dair garanti vermez. Örneğin: parlatma, rektifiye etme, scoring, sulu/kuru kesim, fileleme gibi işlemler sonucu oluşacak hatalar garanti kapsamı dışındadır.
- 3.21. Koyu renkli derz dolgu malzemelerinin kullanımı, derz dolgusunun kimyasal yapısındaki renk pigmentlerinden dolayı önerilmemektedir. Kullanılması durumunda ise, derz uygulaması yapılmadan önce birkaç karo üzerinde, lekelenme performansı açısından test edilmelidir. Lekelenme riski görülen ürünlerde uygulama öncesi karolar yüzey koruyucu film astar veya benzeri bir malzeme ile kaplanmalı, ardından derz uygulaması yapılmalıdır.
- 3.22. Koyu renkli (siyahı antrasit, koyu mavi vb) derz dolgu malzemelerinin kullanılması halinde, derzlerin kimyasal yapısından kaynaklanan lekelenmeler oluşabileceğinden, bu gibi lekeler garanti kapsamı dışındadır.
- 3.23. Kuru alanlarda kullanılacak olan ürünlerimiz için minimum C2 tipinde, ıslak alanlarda veya havuz için kullanıma uygun olduğu beyan edilen ürünlerin havuzda kullanımı için ise minimum C2TE S2 tipinde yapıştırıcıların kullanılması gerekmektedir. Özel uygulama alanları için ilgili alanın ihtiyaçlarına uygun karo seramik yapıştırıcıları kullanılmalıdır (esnek, çok esnek, hızlı prizlenen, soğuğa dayanıklı vb). Özel yapıştırıcı tipleri için yapıştırıcı firmalarından bilgi alınmalı ve yönlendirmelerine göre uygulama yapılmalıdır.
- 3.24. Ürünlerimizin altlarının, uygun seramik malası ve yapıştırma tekniği ile, zemin ve karo seramik arasında boşluk kalmayacak şekilde, seramik yapıştırıcı malzemelerle tam doldurulması esastır. Karonun altında boşluk olması, karoların yük taşıma ve darbe dayanımı performanslarını doğrudan etkilemektedir. Karo altlarında boşluk bulunması durumunda ürünler, mukavemet özellikleri açısından garanti kapsamı dışında kalmaktadır.

* Ürünlerimizin, Garanti Koşullarının, Temizlik ve Bakım Talimatlarının yanı sıra Ürün Teknik Özellikleri ve döşeme talimatlarıyla ilgili en son bilgileri aşağıdaki web sitelerinde bulabilirsiniz:

www.vitra.com.tr / <https://vitraglobal.com/>

A series of horizontal dashed lines for writing notes.

A series of horizontal dashed lines for writing.

Contacts / İletişim

Headquarters

Genel merkez

VitrA Karo San. ve Tic. A.Ş.

Büyükdere Cad. Ali Kaya Sok. No: 5
Levent, 34394 İstanbul
Phone: +90 (212) 350 80 00
Fax: +90 (212) 350 85 58

Regional offices

Bölge ofisleri

VitrA Fliesen GmbH-Co. KG.

Brucknerstrasse 43
56566 Neuwied, Germany
Phone: +49 (2622) 7007-0
Fax: +49 (2622) 7007-60

VitrA UK Ltd.

Park 34 Collet Way,
Didcot Oxon OX11 7WB, UK
Phone: +44 (1235) 750 990
Fax: +44 (1235) 750 985

VitrA Plitka LLC

142253, bld. 1, Bolshevik Settlement,
Serpukhov District, Moscow Region, Russia
Phone: +7 (496) 738 06 08
Fax: +7 (495) 520 78 76

vitrafliesen.de

Flagship showrooms

Flagship mağazalar

VitrA Nişantaşı

Vali Konağı Cad. No: 24, Nişantaşı
Şişli, İstanbul
Phone: +90 (212) 233 07 78
Fax: +90 (212) 232 94 67

VitrA Suadiye

VitrA Suadiye (Cavit Paşa Köşkü)
Bağdat Cad. 493-1, Bostancı
Kadıköy, 34744 İstanbul
Phone: +90 (216) 467 06 40

VitrA Cologne

Agrippinawerft 24
D-50678 Köln, Cologne
Phone: +49 (221) 27 73 68-0
Fax: +49 (2622) 88 95 500

VitrA London

Unit 2
64 Turnmill Street
EC1M 5RR London
E-mail: london@vitra.co.uk

VitrA Moscow

Varshavskoe Highway, 9, Bld.1
“Danilovskaya Manufaktura” Office Center
117105 Moscow
Phone / Fax: +7 (495) 221 76 11

Attention

When ordering ceramic tiles specify the areas of use.
Before tile setting, verify the tonality and calibration numbers, claims regarding these indications cannot be accepted after tile setting.
Crazing of glass borders is a nature of the ceramic tiles.
It is recommended to use VitrA Fix grout and adhesive materials with VitrA Ceramic Tiles.
The colours of tiles in the catalogue may not reflect the exact colours of the products.
For the compatibility of the products to be used with complementary parts, a special order note should be added requesting the simultaneous production of all tiles. There may be a colour tone difference in products produced at different times.
VitrA Karo San. ve Tic. A.Ş. reserves the right to change the products and technical specifications.

Dikkat

Seramik karoları sipariş ederken kullanım alanlarını belirtiniz.
Seramik karoları döşemedenden önce lütfen tonalite ve kalibre numaralarının aynı mekânlar için aynı olmasına dikkat ediniz; döşendikten sonra sorumluluk kabul edilmez.
Camsı bordürlerde Kraküle (çatlama) olabilir, seramiğin doğasında olan bir unsurdur.
VitrA Karo Seramikleri ile birlikte VitrA Fix derz dolgu ve yapıştırıcı malzemeleri kullanılmasını önerilir.
Katalogdaki ürün renkleri seramik karoların renklerini aynen yansıtmayabilir.
Tamamlayıcı parçalar ile bu parçaların birlikte döşeneceği ürünlerin uyumu için sipariş notu düşülerek üretim yapılmalıdır. Farklı zamanlarda üretilen ürünlerde renk tonu farkı olabilir.
VitrA Karo San. ve Tic. A.Ş.'nin ürünler ve teknik detaylarında değişiklik yapma hakkı saklıdır.

VitrA